

LISA3-RS-PIN

~15° spot beam with location pin installation

TECHNICAL SPECIFICATIONS:

Dimensions	Ø 10.0 mm
Height	7.9 mm
Fastening	glue
Colour	black
Box size	310 x 230 x 60 mm
Box weight	1.3 kg
Quantity in Box	2000 pcs
ROHS compliant	yes ⓘ



MATERIAL SPECIFICATIONS:

Component	Type	Material	Colour
LISA3-RS	Single lens	PMMA	
LISA3-HLD-PIN	Holder	PC	

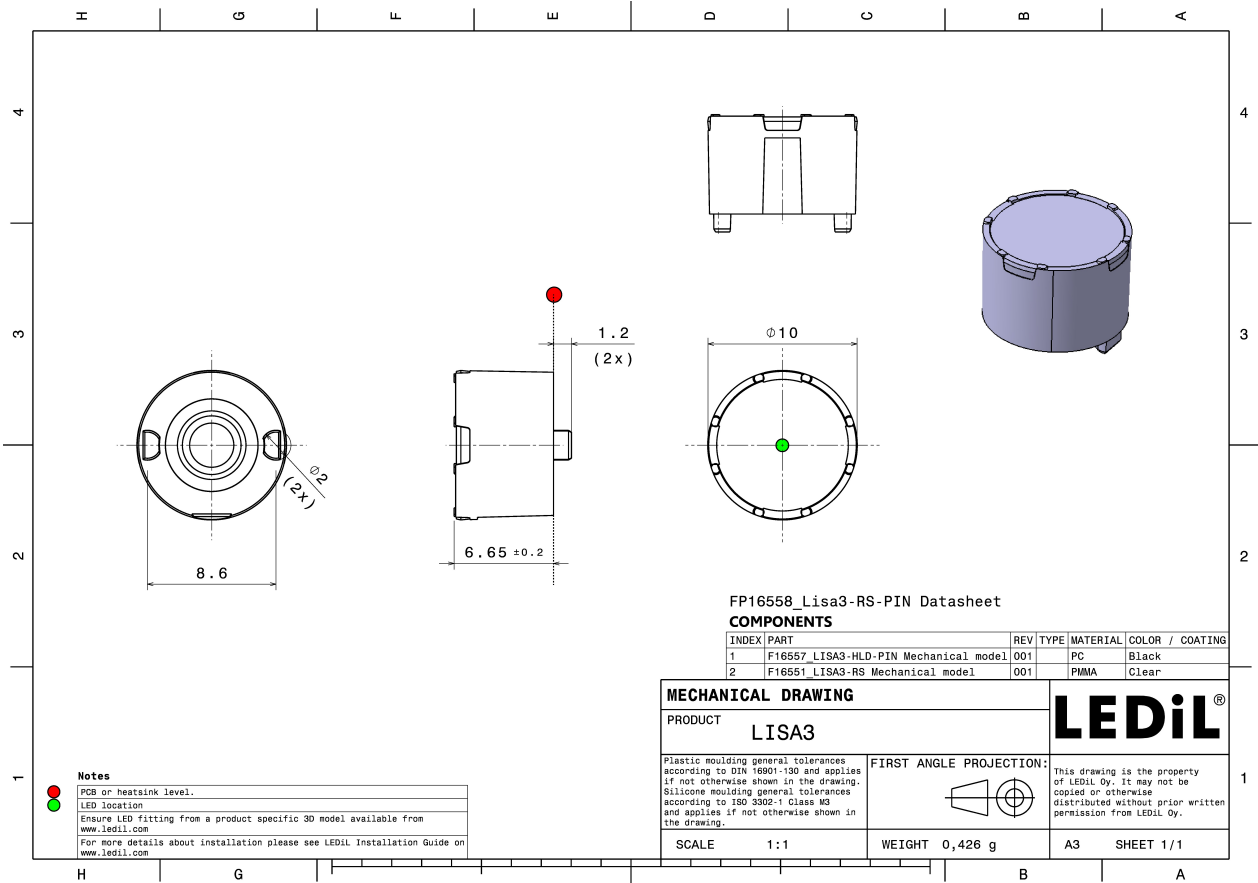

PHOTOMETRIC DATA (MEASURED):



LED NF2x757G
FWHM 25.0°
Efficiency 88 %
Peak intensity 3.300 cd/lm
LEDs/each optic 1
Light colour White
Required components:

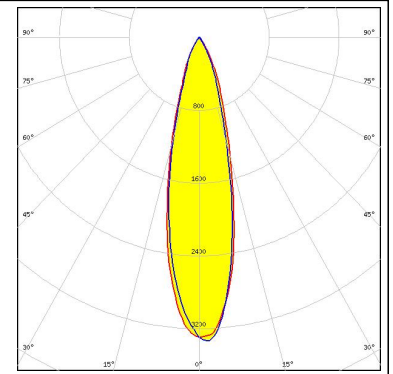
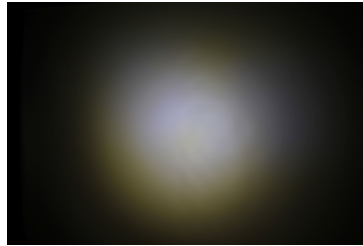

PHOTOMETRIC DATA (SIMULATED):



LED XP-E
 FWHM 15.0°
 Efficiency 90 %
 Peak intensity 8.500 cd/lm
 LEDs/each optic 1
 Light colour White
 Required components:

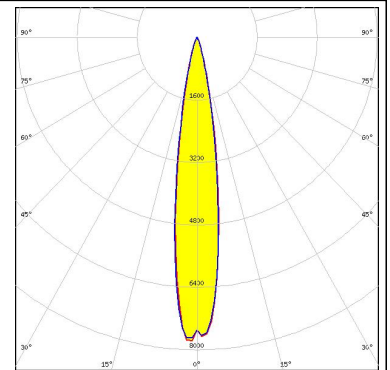

LED XP-E2
 FWHM 14.3°
 Efficiency 89 %
 Peak intensity 9.400 cd/lm
 LEDs/each optic 1
 Light colour White
 Required components:

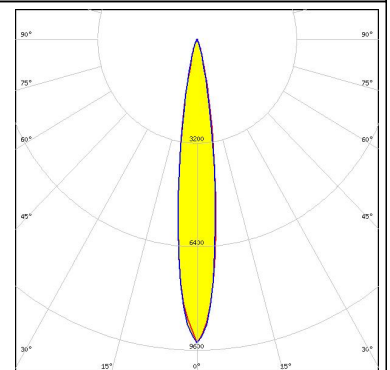

LED XP-G2 HE
 FWHM 27.0°
 Efficiency 86 %
 Peak intensity 2.784 cd/lm
 LEDs/each optic 1
 Light colour White
 Required components:

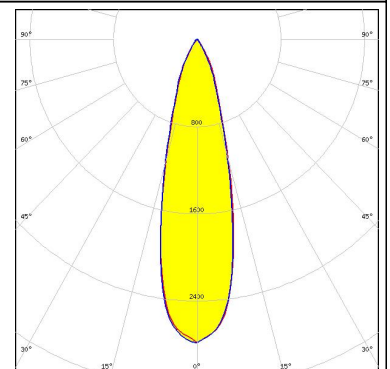

LED XP-G3
 FWHM 26.0°
 Efficiency 86 %
 Peak intensity 3.087 cd/lm
 LEDs/each optic 1
 Light colour White
 Required components:

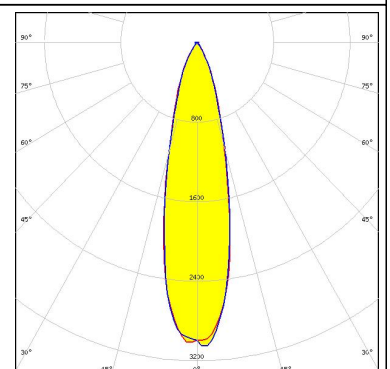

PHOTOMETRIC DATA (SIMULATED):



LED XQ-E HI
FWHM 18.0°
Efficiency 82 %
Peak intensity 6.400 cd/lm
LEDs/each optic 1
Light colour White
Required components:

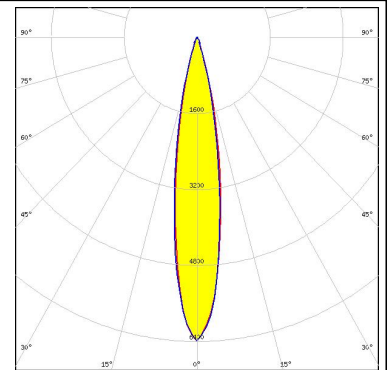

LED LUXEON 2835 Line
FWHM 16.0°
Efficiency 89 %
Peak intensity 6.979 cd/lm
LEDs/each optic 1
Light colour White
Required components:

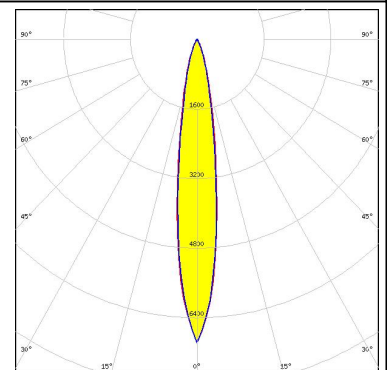

LED LUXEON CZ
FWHM 12.0°
Efficiency 90 %
Peak intensity 13.471 cd/lm
LEDs/each optic 1
Light colour White
Required components:

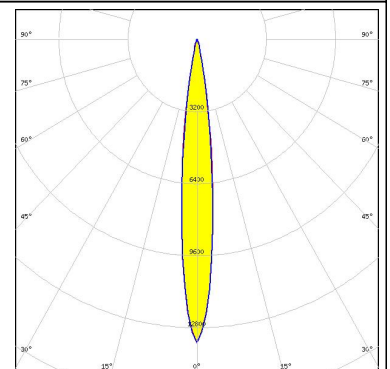

LED LUXEON V2
FWHM 22.0°
Efficiency 90 %
Peak intensity 3.780 cd/lm
LEDs/each optic 1
Light colour White
Required components:

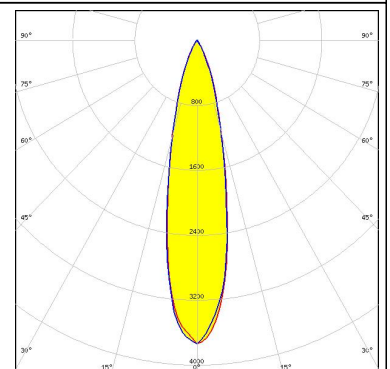

PHOTOMETRIC DATA (SIMULATED):

<p>LUMILEDS</p> <p>LED LUXEON Z FWHM 12.0° Efficiency 87 % Peak intensity 13.200 cd/lm LEDs/each optic 1 Light colour White Required components:</p>	
<p>LUMILEDS</p> <p>LED LUXEON Z ES FWHM 15.0° Efficiency 88 % Peak intensity 9.018 cd/lm LEDs/each optic 1 Light colour White Required components:</p>	
<p>NICHIA</p> <p>LED NVSW219F FWHM 26.0° Efficiency 88 % Peak intensity 3.320 cd/lm LEDs/each optic 1 Light colour White Required components:</p>	
<p>NICHIA</p> <p>LED NVSxx19B/NVSxx19C FWHM 25.0° Efficiency 85 % Peak intensity 3.470 cd/lm LEDs/each optic 1 Light colour White Required components:</p>	

PHOTOMETRIC DATA (SIMULATED):

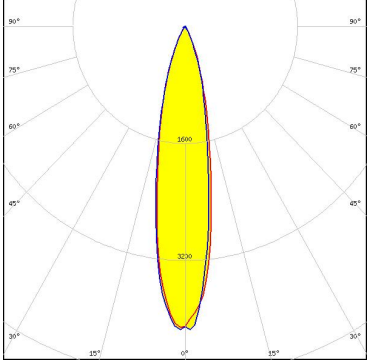
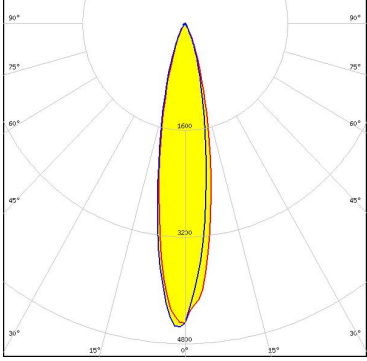
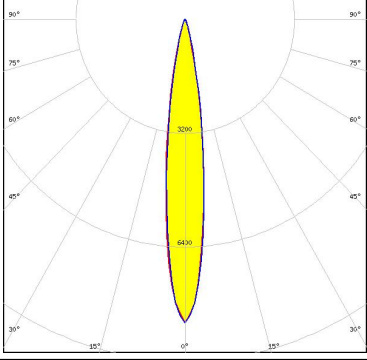
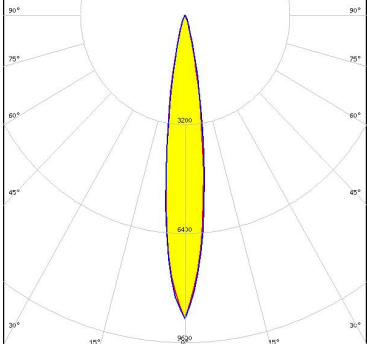
<p>OSRAM Opto Semiconductors</p> <p>LED Duris S5 (2 chip) FWHM 20.0° Efficiency 87 % Peak intensity 7.050 cd/lm LEDs/each optic 1 Light colour White Required components:</p>	
<p>OSRAM Opto Semiconductors</p> <p>LED Duris S5 (Single chip) FWHM 20.0° Efficiency 86 % Peak intensity 4.500 cd/lm LEDs/each optic 1 Light colour White Required components:</p>	
<p>OSRAM Opto Semiconductors</p> <p>LED OSCONIQ P 3030 FWHM 14.0° Efficiency 86 % Peak intensity 8.535 cd/lm LEDs/each optic 1 Light colour White Required components:</p>	
<p>OSRAM Opto Semiconductors</p> <p>LED OSLOM SSL 150 FWHM 14.5° Efficiency 88 % Peak intensity 8.740 cd/lm LEDs/each optic 1 Light colour White Required components:</p>	

PHOTOMETRIC DATA (SIMULATED):

<p>OSRAM Opto Semiconductors</p> <p>LED OSOLON SSL 80 FWHM 15.0° Efficiency 87 % Peak intensity 7.550 cd/lm LEDs/each optic 1 Light colour White Required components:</p>	
<p>OSRAM Opto Semiconductors</p> <p>LED SFH 4715AS FWHM 22.0° Efficiency 86 % Peak intensity cd/lm LEDs/each optic 1 Light colour IR Required components:</p>	
<p>OSRAM Opto Semiconductors</p> <p>LED SFH 4716AS FWHM 17.0° Efficiency 87 % Peak intensity cd/lm LEDs/each optic 1 Light colour IR Required components:</p>	
<p>SAMSUNG</p> <p>LED LH351B FWHM 26.0° Efficiency 88 % Peak intensity 3.469 cd/lm LEDs/each optic 1 Light colour White Required components:</p>	

PHOTOMETRIC DATA (SIMULATED):

SAMSUNG

LED LM301A
FWHM 14.5°
Efficiency 87 %
Peak intensity 7.050 cd/lm
LEDs/each optic 1
Light colour White
Required components:

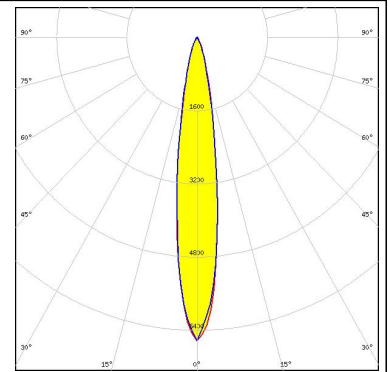

SAMSUNG

LED LM302A
FWHM 16.0°
Efficiency 87 %
Peak intensity 5.300 cd/lm
LEDs/each optic 1
Light colour White
Required components:

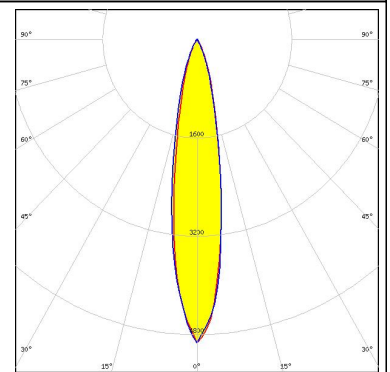

GENERAL INFORMATION:

NOTE: The typical beam angle will be changed by different color, chip size and chip position tolerance. The typical total beam angle is the full angle measured where the luminous intensity is half of the peak value.

MATERIALS:

As part of our continuous research and improvement processes, and to ensure the best possible quality and availability of our products, LEDiL reserves the right to change material grades without notice.

PRODUCT DATA USER AGREEMENT AND DISCLAIMER:

The measured data in the provided downloadable LEDiL Product Datasheets and Mechanical 2D-Drawings is rounded and provided as reference for planning. LEDiL Oy's optical specifications have been verified by conducting performance testing of the products in accordance with the company's quality system. The reported data are averaged results of multiple measurements with typical variation. LEDiL Oy reserves the right to without prior notification make changes and improvements to its products.

LEDiL Oy assumes neither warranty, nor guarantee nor any other liability of any kind for the contents and correctness of the provided data. The provided data has been generated with highest diligence but the provided data may in reality not represent the complete possible variation range of all intrinsic parameters. Therefore, in certain cases a deviation from the provided data could occur.

LEDiL Oy reserves the right to undertake technical changes of its products without further notification which could lead to changes in the provided data. LEDiL Oy assumes no liability of any kind for the possible deviation from any provided data or any other damage resulting from the usage of the provided data.

The user agrees to this disclaimer and user agreement with the download or usage of the provided files.

LEDiL Oy

Joensuunkatu 13
FI-24240 SALO
Finland

LEDiL Inc.

228 West Page Street
Suite D
Sycamore IL 60178
USA

Local sales and technical support

[www.ledil.com/
where_to_buy](http://www.ledil.com/where_to_buy)

Shipping locations

Salo, Finland
Hong Kong, China

Distribution Partners

[www.ledil.com/
where_to_buy](http://www.ledil.com/where_to_buy)