



APPLICATION SPECIFICATION

2.4/5GHZ BALANCE FLEX ANTENNA

TABLE OF CONTENTS

1.0 SCOPE

2.0 PRODUCT DESCRIPTION

3.0 APPLICABLE DOCUMENTS

4.0 ANTENNA PERFORMANCE

5.0 ASSEMBLY GUIDELINE

6.0 RF PERFORMANCE AS A FUNCTION OF IMPLEMENTATION

7.0 THE ANTENNA PERFORMANCE VARIATION WITH CABLE LENGTH

REVISION: G	ECR/ECN INFORMATION: EC No: 609928 DATE: 2019/02/15	TITLE: 2.4/5GHz Balance Flex Antenna Application Specification	SHEET No. 1 of 22
DOCUMENT NUMBER: AS-1461530100	CREATED / REVISED BY: Liu Hai 2019/02/15	CHECKED BY: Andy Zhang 2019/02/15	APPROVED BY: Chris Zhong 2019/02/15

2.4/5GHZ BALANCE FLEX ANTENNA

1.0 SCOPE

This specification describes the antenna application and surrounding. The information in this document is for reference and benchmark purposes only. The user is responsible for validating antenna rf performance based on the user's actual implementation.

Antenna illustrations in this document are generic representations. They are not intended to be an image of any antenna listed in the scope.

2.0 PRODUCT DESCRIPTION

2.1 PRODUCT NAME AND SERIES NUMBER (S)

Product name: 2.4/5GHz Balance Flex Antenna

Series Number: 146153XXXX

2.2 DESCRIPTION

Series 146153 is a balanced, high efficiency antenna for 2.4/5 GHz applications, including WIFI, Bluetooth, Zigbee and others. Antenna size 35x9x0.1mm is made from flexible polymer material, cable standard length 100mm. It can be easily installed by simply "peel and stick" on non-metal surface.

2.3 PRODUCT STRUCTURE INFORMATION

Please refer to PS-1461530100 for full information.



Molex 146153**** 2.4/5GHz Balance Flex Antenna 3D View

REVISION: G	ECR/ECN INFORMATION: EC No: 609928 DATE: 2019/02/15	TITLE: 2.4/5GHz Balance Flex Antenna Application Specification	SHEET No. 2 of 22
DOCUMENT NUMBER: AS-1461530100	CREATED / REVISED BY: Liu Hai 2019/02/15	CHECKED BY: Andy Zhang 2019/02/15	APPROVED BY: Chris Zhong 2019/02/15

3.0 APPLICABLE DOCUMENTS

DOCUMENT	NUMBER	DESCRIPTION
Sale Drawing (SD)	SD-1461530050/ SD-1461531050	Mechanical Dimension of the product
Product Specification (PS)	PS-1461530100	Product Specification
Packing Drawing (PK)	PK-1461530100	Product packaging specifications

4.0 ANTENNA PERFORMANCE

4.1 RF TEST CONDITIONS

All measurements are done of the antenna mounted on a PC/ABS material block of 1.5mm thickness with VNA Agilent E5071C and Over-The-Air (OTA) chamber. All measurements in this document are done with the part no.1461530100 with a cable length of 100mm.

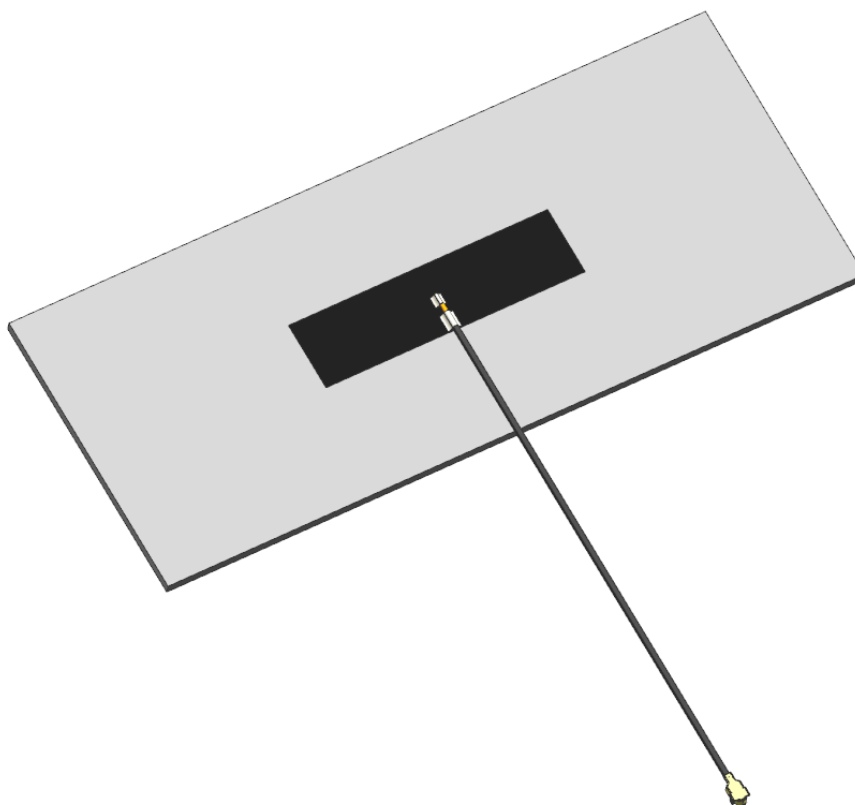

FIGURE4.1.1 ANTENNA LOADED WITH PC/ABS BLOCK OF 1.5 MM THICKNESS

REVISION: G	ECR/ECN INFORMATION: EC No: 609928 DATE: 2019/02/15	TITLE: 2.4/5GHz Balance Flex Antenna Application Specification	SHEET No. 3 of 22
DOCUMENT NUMBER: AS-1461530100	CREATED / REVISED BY: Liu Hai 2019/02/15	CHECKED BY: Andy Zhang 2019/02/15	APPROVED BY: Chris Zhong 2019/02/15

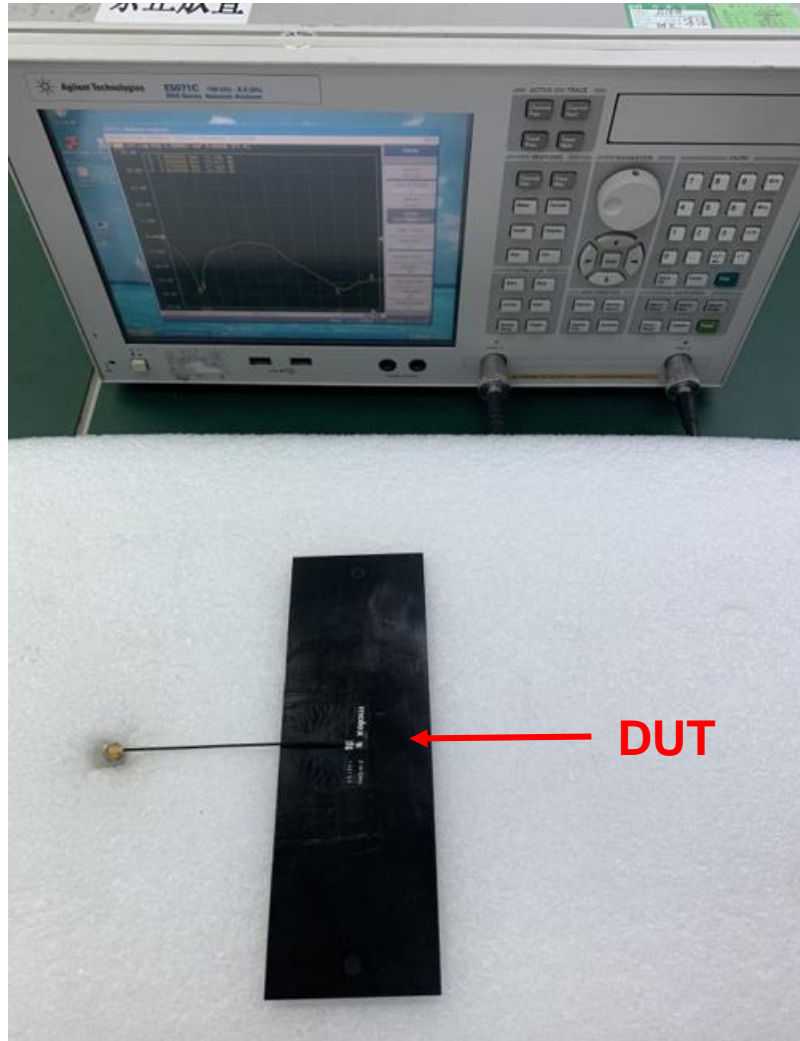

FIGURE4.1.2 ANTENNA LOADED WITH PC/ABS BLOCK OF 1.5 MM THICKNESS WITH VNA

REVISION: G	ECR/ECN INFORMATION: EC No: 609928 DATE: 2019/02/15	TITLE: 2.4/5GHz Balance Flex Antenna Application Specification		SHEET No. 4 of 22
DOCUMENT NUMBER: AS-1461530100		CREATED / REVISED BY: Liu Hai 2019/02/15	CHECKED BY: Andy Zhang 2019/02/15	APPROVED BY: Chris Zhong 2019/02/15

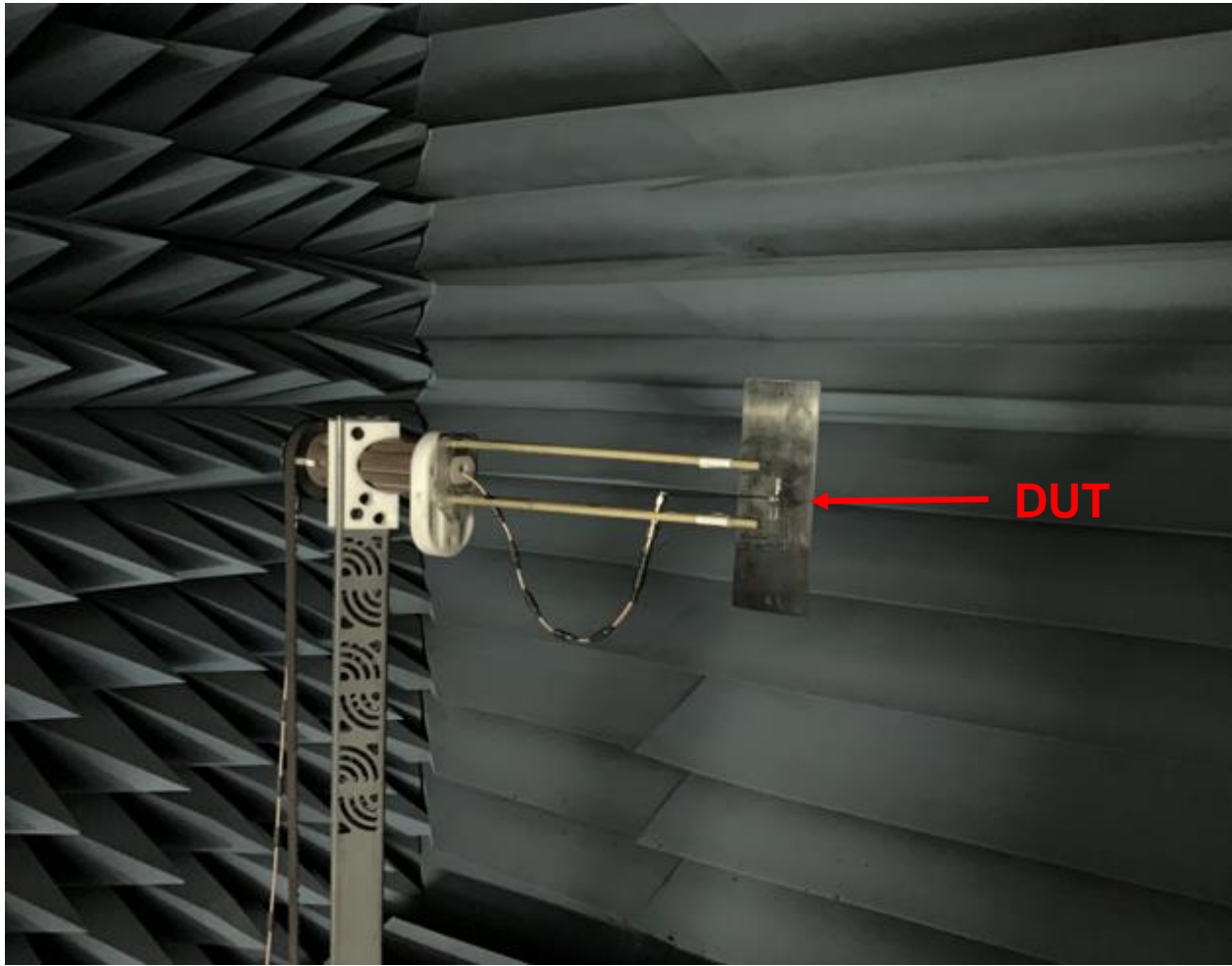

FIGURE4.1.3 ANTENNA LOADED WITH PC/ABS BLOCK OF 1.5 MM THICKNESS WITH OTA CHAMBER

REVISION: G	ECR/ECN INFORMATION: EC No: 609928 DATE: 2019/02/15	TITLE: 2.4/5GHz Balance Flex Antenna Application Specification		SHEET No. 5 of 22
DOCUMENT NUMBER: AS-1461530100		CREATED / REVISED BY: Liu Hai 2019/02/15	CHECKED BY: Andy Zhang 2019/02/15	APPROVED BY: Chris Zhong 2019/02/15



APPLICATION SPECIFICATION

4.2 ANTENNA PERFORMANCE

DESCRIPTION	EQUIPMENT	REQUIREMENT	
Frequency Range	VNA E5071C	2.4-2.5GHz	5.15-5.85GHz
Return Loss	VNA E5071C	<- 10dB	
Peak Gain (Max)	OTA Chamber	3.1dBi	7.1dBi
Average Total Efficiency	OTA Chamber	>80%	>80%
Polarization	OTA Chamber	Linear	
Input Impedance	VNA E5071C	50 ohms	

Note that the above antenna performance is measured with just the antenna mounted on a PC/ABS block to similar a free-space condition. When implement into the system, the frequency resonant might be off-tune due to the loading of surrounding components especially metal plane. This off-tune can be compensated through matching. Although module manufacturers specify a peak gain limit, it is based on free-space conditions. The peak gain will be degraded by 1 to 2dBi in the actual implementation as the radiation pattern will change due to the surround components. As such, during selection of antenna, you can select one with high peak gain to compensate for the loss. Molex can offer assistant to choose the best location and best tuning in-order to meet this peak gain requirement.

REVISION: G	ECR/ECN INFORMATION: EC No: 609928 DATE: 2019/02/15	TITLE: 2.4/5GHz Balance Flex Antenna Application Specification	SHEET No. 6 of 22
DOCUMENT NUMBER: AS-1461530100	CREATED / REVISED BY: Liu Hai 2019/02/15	CHECKED BY: Andy Zhang 2019/02/15	APPROVED BY: Chris Zhong 2019/02/15

4.3 RETURN LOSS PLOT

All measurements in this document are done with a cable length of 100mm.

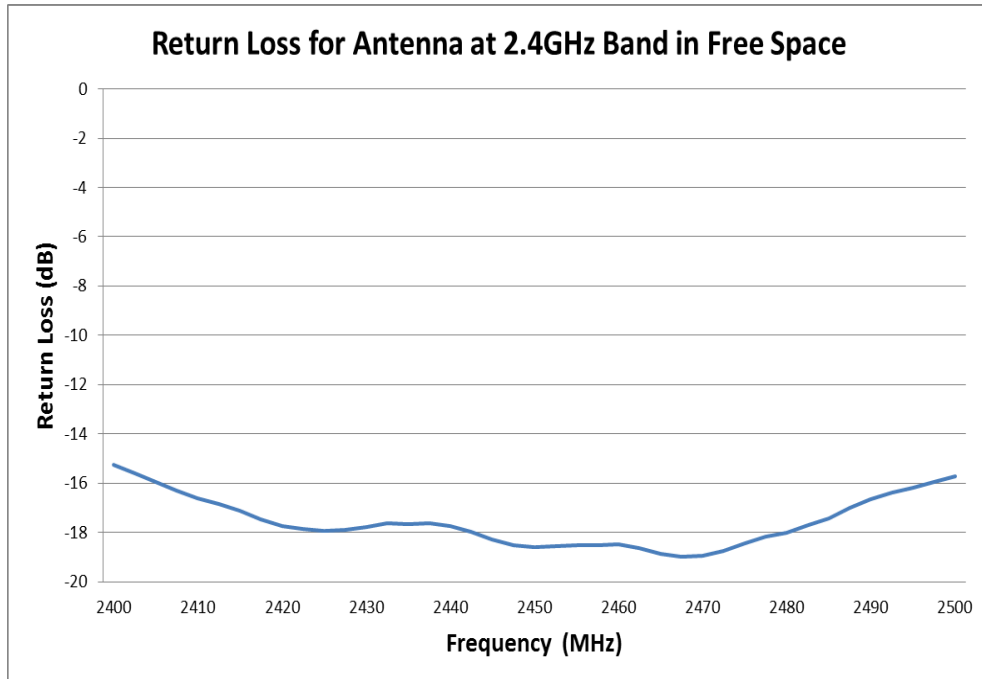

FIGURE 4.3.1 RETURN LOSS OF ANTENNA AT 2.4GHZ BAND IN FREE SPACE

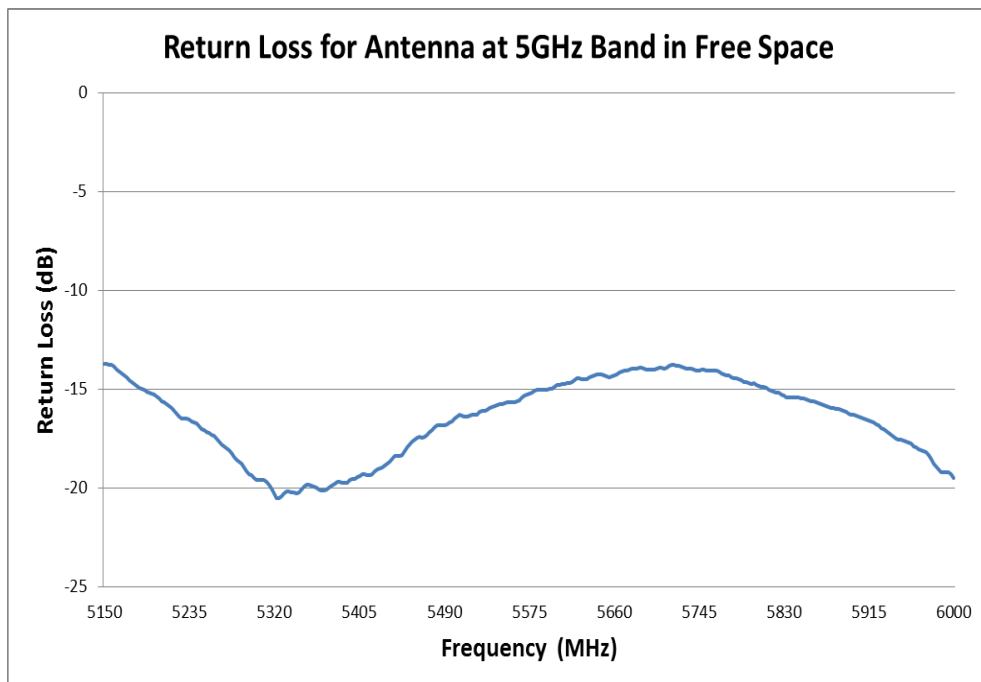

FIGURE 4.3.2 RETURN LOSS OF ANTENNA AT 5GHZ BAND IN FREE SPACE

REVISION: G	ECR/ECN INFORMATION: EC No: 609928 DATE: 2019/02/15	TITLE: 2.4/5GHz Balance Flex Antenna Application Specification	SHEET No. 7 of 22
DOCUMENT NUMBER: AS-1461530100	CREATED / REVISED BY: Liu Hai 2019/02/15	CHECKED BY: Andy Zhang 2019/02/15	APPROVED BY: Chris Zhong 2019/02/15

4.4 EFFICIENCY PLOT

All measurements in this document are done with a cable length of 100mm.

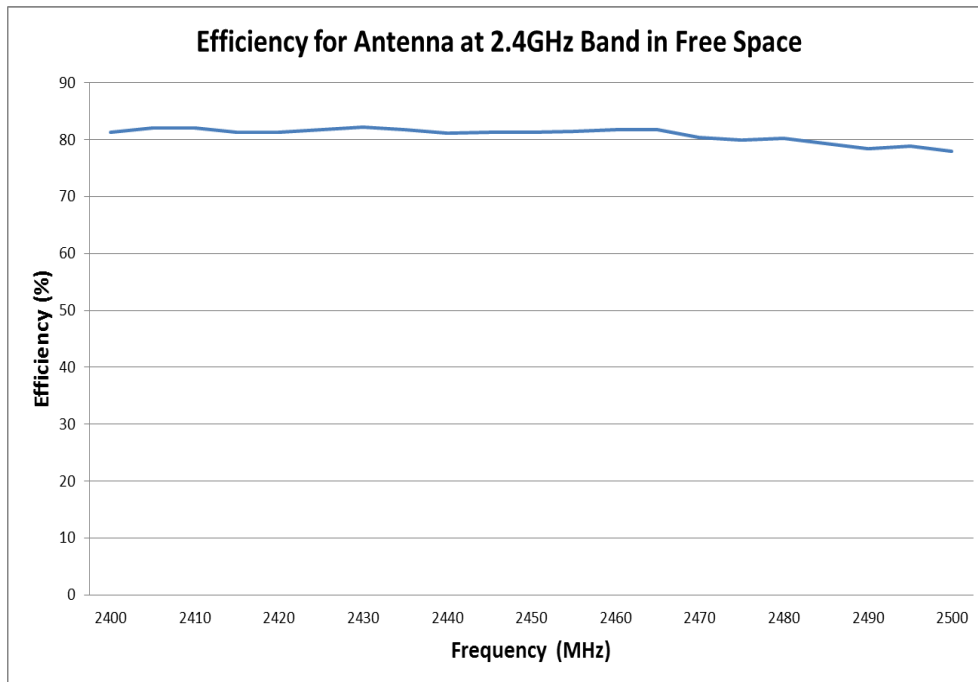

FIGURE 4.4.1 EFFICIENCY OF ANTENNA AT 2.4GHZ BAND IN FREE SPACE

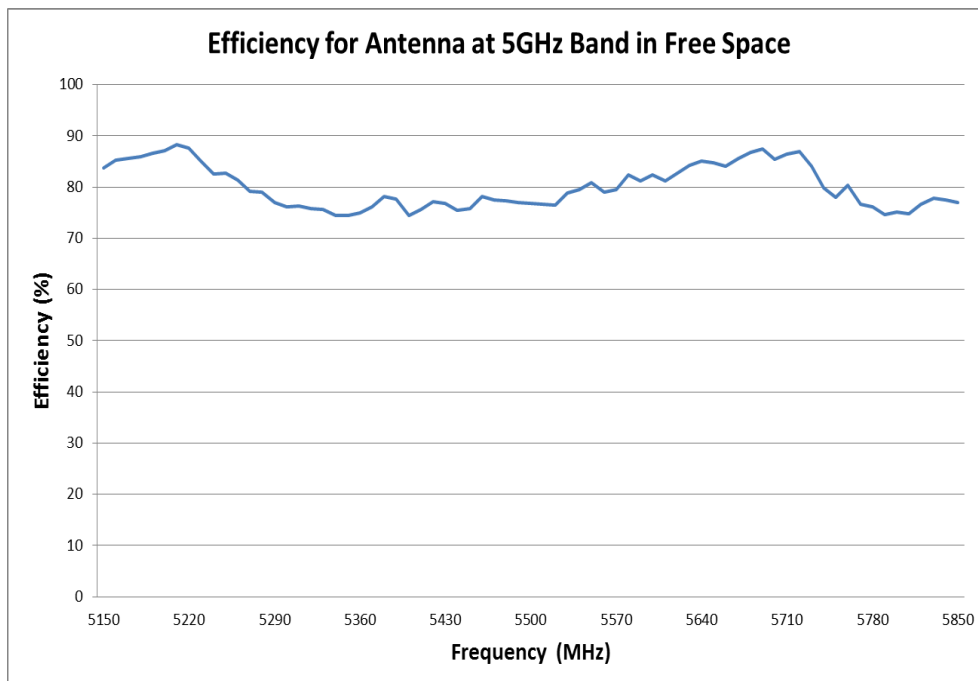

FIGURE 4.4.2 EFFICIENCY OF ANTENNA AT 5GHZ BAND IN FREE SPACE

REVISION: G	ECR/ECN INFORMATION: EC No: 609928 DATE: 2019/02/15	TITLE: 2.4/5GHz Balance Flex Antenna Application Specification	SHEET No. 8 of 22
DOCUMENT NUMBER: AS-1461530100	CREATED / REVISED BY: Liu Hai 2019/02/15	CHECKED BY: Andy Zhang 2019/02/15	APPROVED BY: Chris Zhong 2019/02/15

4.5 RADIATION PATTERN

All measurements in this document are done with a cable length of 100mm.

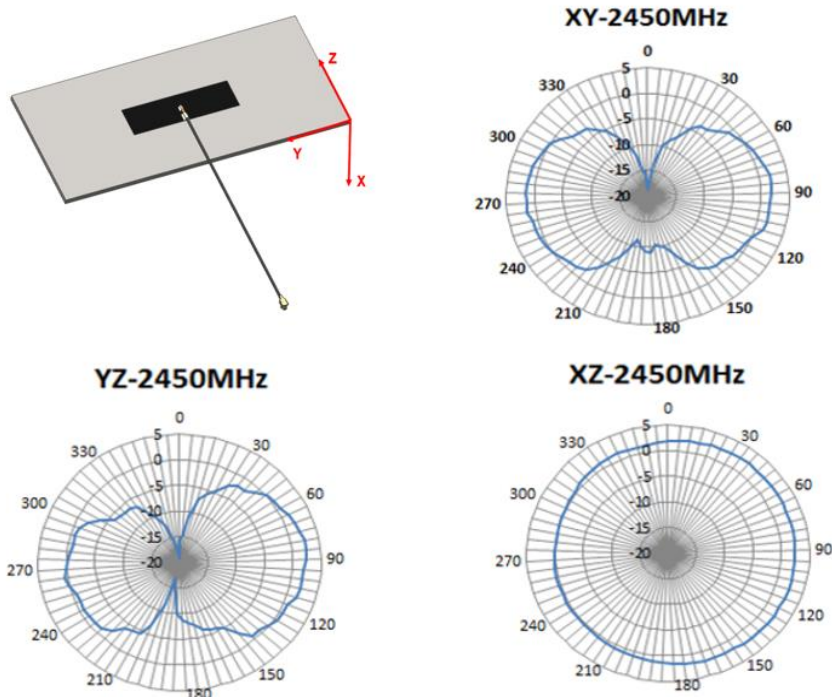

FIGURE 4.5.1 2D RADIATION PATTERN OF ANTENNA AT 2450MHZ IN FREE SPACE

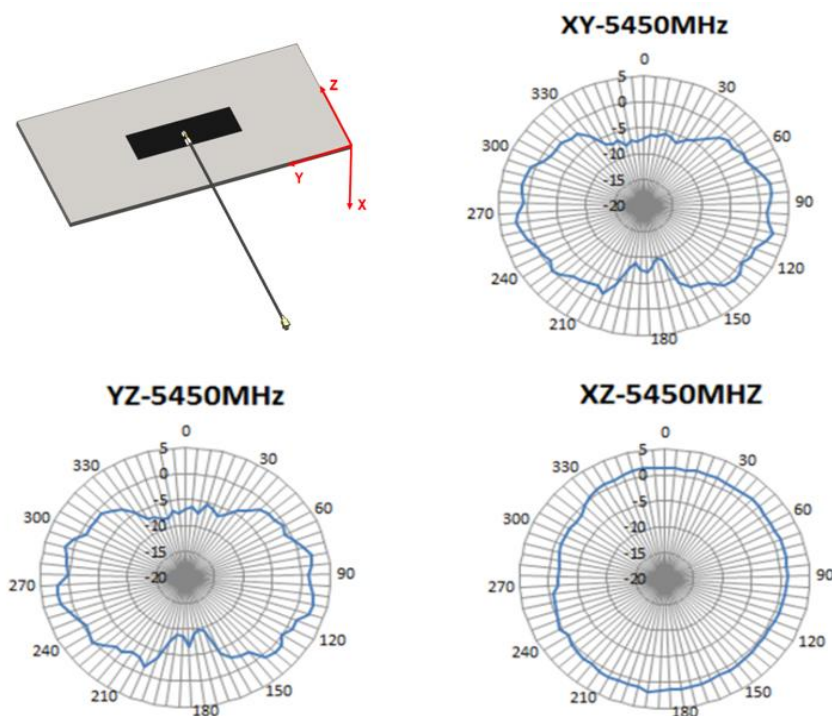

FIGURE 4.5.2 2D RADIATION PATTERN OF ANTENNA AT 5450MHZ IN FREE SPACE

REVISION: G	ECR/ECN INFORMATION: EC No: 609928 DATE: 2019/02/15	TITLE: 2.4/5GHz Balance Flex Antenna Application Specification	SHEET No. 9 of 22
DOCUMENT NUMBER: AS-1461530100	CREATED / REVISED BY: Liu Hai 2019/02/15	CHECKED BY: Andy Zhang 2019/02/15	APPROVED BY: Chris Zhong 2019/02/15

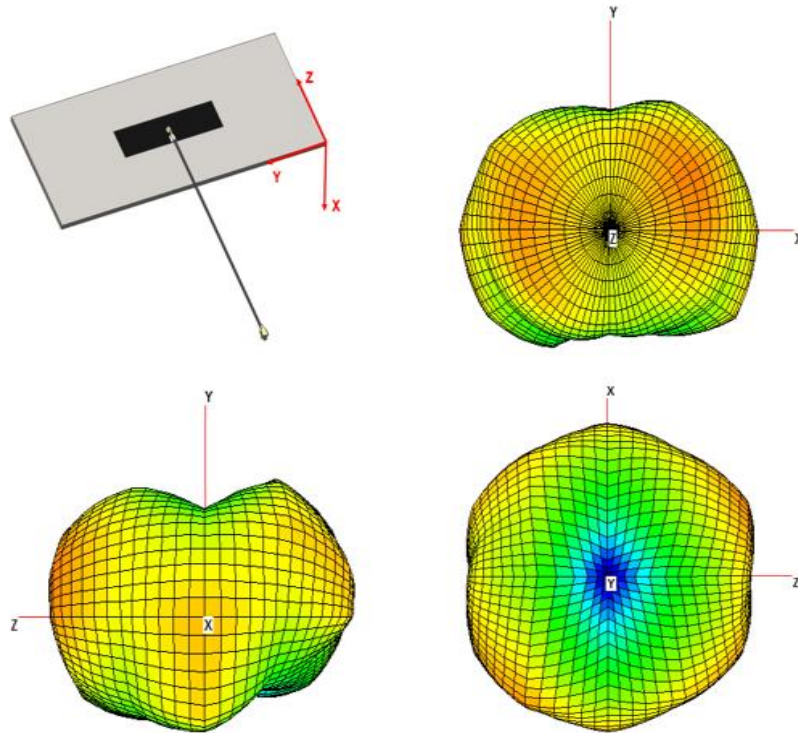

FIGURE 4.5.3 3D RADIATION PATTERN OF ANTENNA AT 2450MHZ BAND IN FREE SPACE

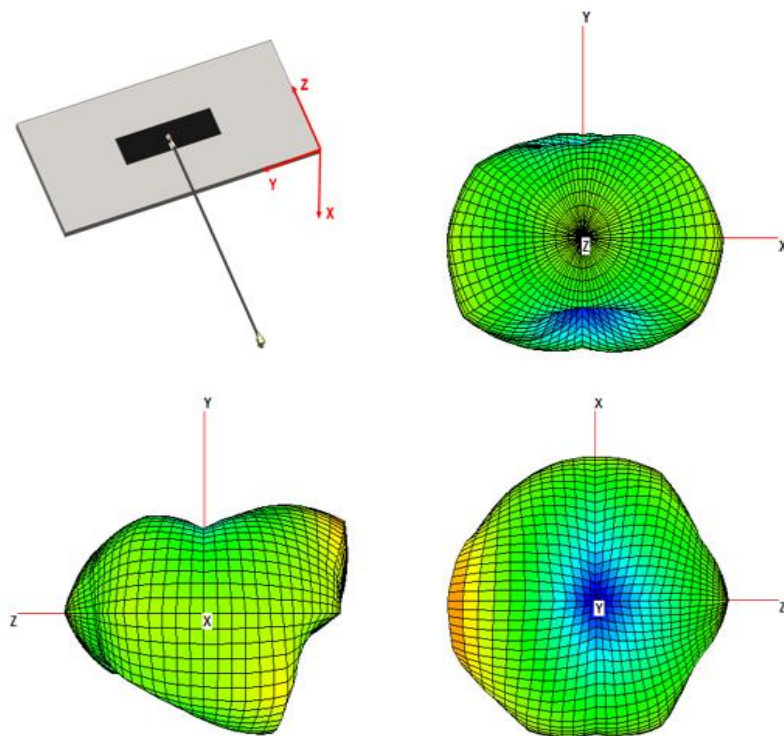

FIGURE 4.5.4 3D RADIATION PATTERN OF ANTENNA AT 5450MHZ BAND IN FREE SPACE

REVISION: G	ECR/ECN INFORMATION: EC No: 609928 DATE: 2019/02/15	TITLE: 2.4/5GHz Balance Flex Antenna Application Specification	SHEET No. 10 of 22
DOCUMENT NUMBER: AS-1461530100	CREATED / REVISED BY: Liu Hai 2019/02/15	CHECKED BY: Andy Zhang 2019/02/15	APPROVED BY: Chris Zhong 2019/02/15

5.0 ASSEMBLY GUIDELINE

The flex antenna comes with an adhesive 3m9077 for assemble onto the plastic wall of the system. The surface should be smooth with $ra < 1.6\mu m$ and need to clean the surface before sticking this product. The antenna cannot be placed on a metallic surface.

5.1 HOW TO TEAR FLEX RELEASE PAPER

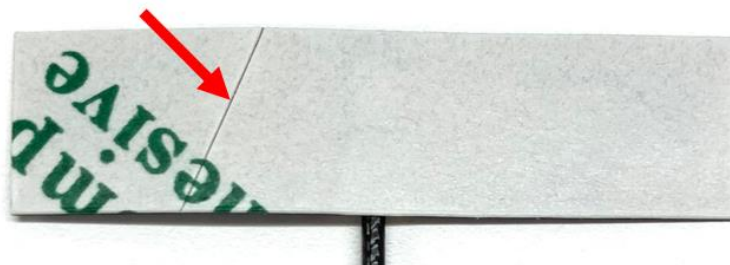

1. Find cut line on flex back side



2. Bend flex slight along cut line

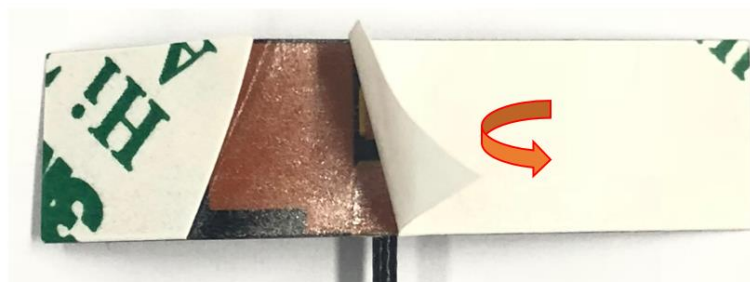

3. Tear release paper

REVISION: G	ECR/ECN INFORMATION: EC No: 609928 DATE: 2019/02/15	TITLE: 2.4/5GHz Balance Flex Antenna Application Specification	SHEET No. 11 of 22
DOCUMENT NUMBER: AS-1461530100	CREATED / REVISED BY: Liu Hai 2019/02/15	CHECKED BY: Andy Zhang 2019/02/15	APPROVED BY: Chris Zhong 2019/02/15

5.2 CABLE BENDING

During the assembly of the antenna in a device, the cable needs to be positioned away from the antenna flex to achieve best performance. The cable must be away from the Flex edge at least 5mm as shown in figure 5.2.1. If the cable bends into the antenna flex, the antenna performance will be degraded.

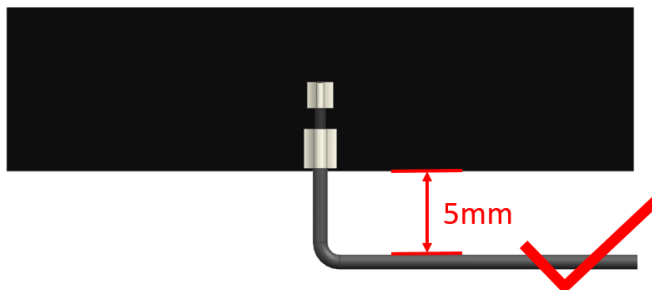

FIGURE 5.2.1 RECOMMENDED CABLE BENDING RANGE

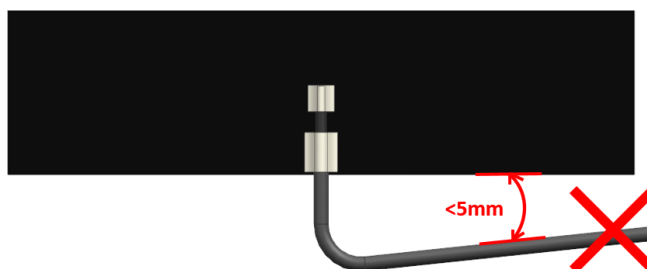

FIGURE 5.2.2 UNRECOMMENDED CABLE BENDING RANGE

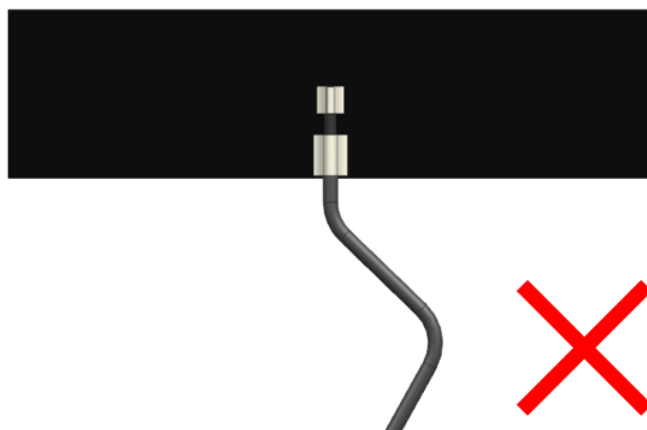

FIGURE 5.2.3 MULTIPLE BENDING OF CABLES IS NOT RECOMMENDED

REVISION: G	ECR/ECN INFORMATION: EC No: 609928 DATE: 2019/02/15	TITLE: 2.4/5GHz Balance Flex Antenna Application Specification	SHEET No. 12 of 22
DOCUMENT NUMBER: AS-1461530100	CREATED / REVISED BY: Liu Hai 2019/02/15	CHECKED BY: Andy Zhang 2019/02/15	APPROVED BY: Chris Zhong 2019/02/15

6.0 RF PERFORMANCE AS A FUNCTION OF IMPLEMENTATION

6.1 ANTENNA RF PERFORMANCE AS A FUNCTION OF DIFFERENT LOCATIONS WITH PARALLEL PLANE GROUND

Four locations with parallel plane ground have been evaluated and these locations are shown in figure 6.1.1. The plane ground size is 90mm*90mm and we move the plane ground to four locations for each test. The antenna performance is better with larger distance between antenna and parallel plane ground. The minimum distance between antenna and plane ground is recommended to be 15mm to achieve acceptable RF performance.

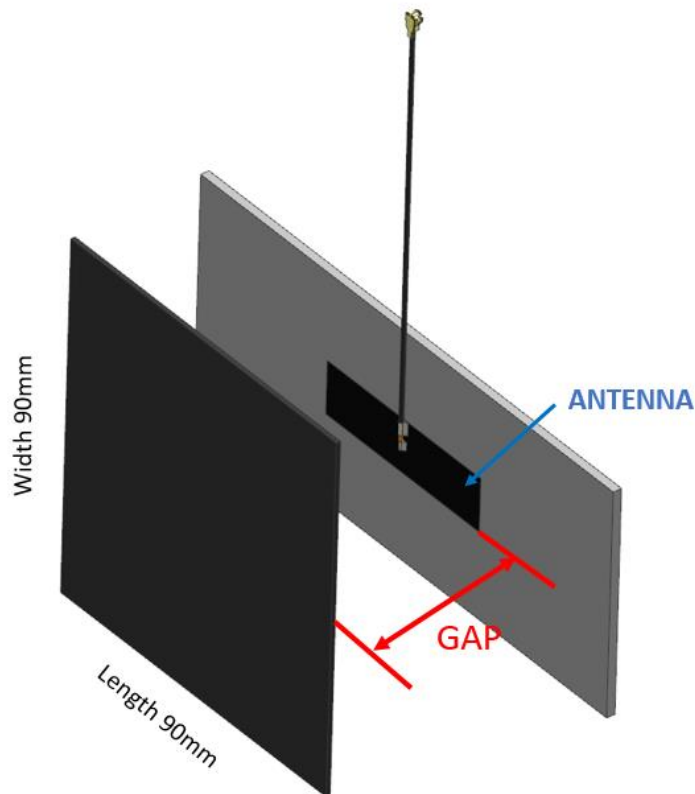

FIGURE 6.1.1 FOUR LOCATIONS WITH PARALLEL PLANE GROUND

Ground Size: 90mm*90mm;

- Location 1: Distance between antenna and plane (GAP) ground is about 5mm;
- Location 2: Distance between antenna and plane (GAP) ground is about 10mm;
- Location 3: Distance between antenna and plane (GAP) ground is about 15mm;
- Location 4: Distance between antenna and plane (GAP) ground is about 20mm.

REVISION: G	ECR/ECN INFORMATION: EC No: 609928 DATE: 2019/02/15	TITLE: 2.4/5GHz Balance Flex Antenna Application Specification	SHEET No. 13 of 22
DOCUMENT NUMBER: AS-1461530100	CREATED / REVISED BY: Liu Hai 2019/02/15	CHECKED BY: Andy Zhang 2019/02/15	APPROVED BY: Chris Zhong 2019/02/15

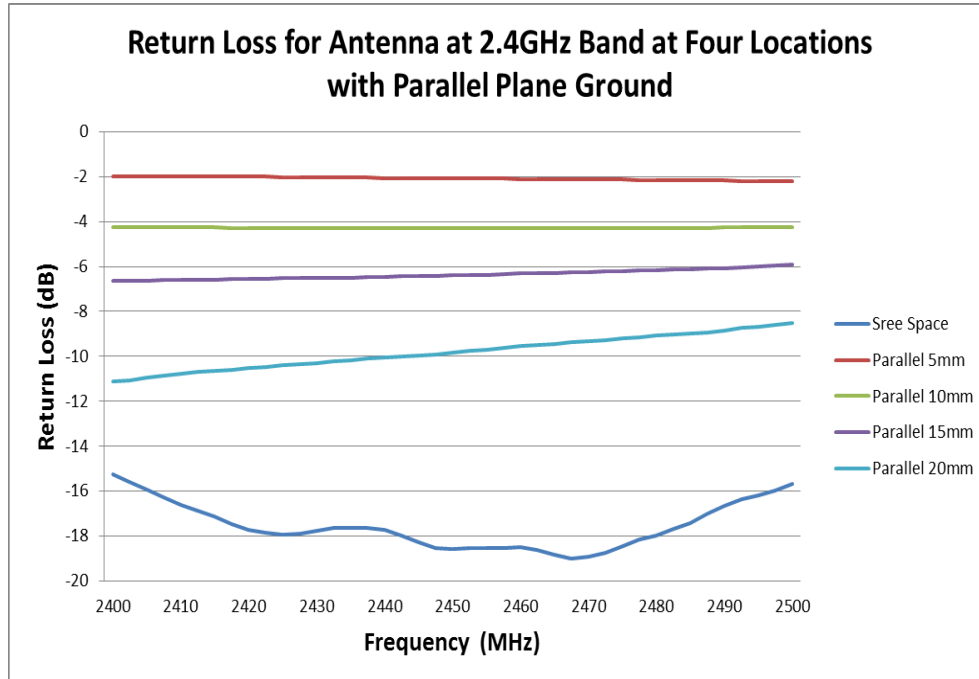

FIGURE 6.1.2 RETURN LOSS OF ANTENNA AT 2.4GHZ BAND AT FOUR LOCATIONS WITH PARALLEL PLANE GROUND

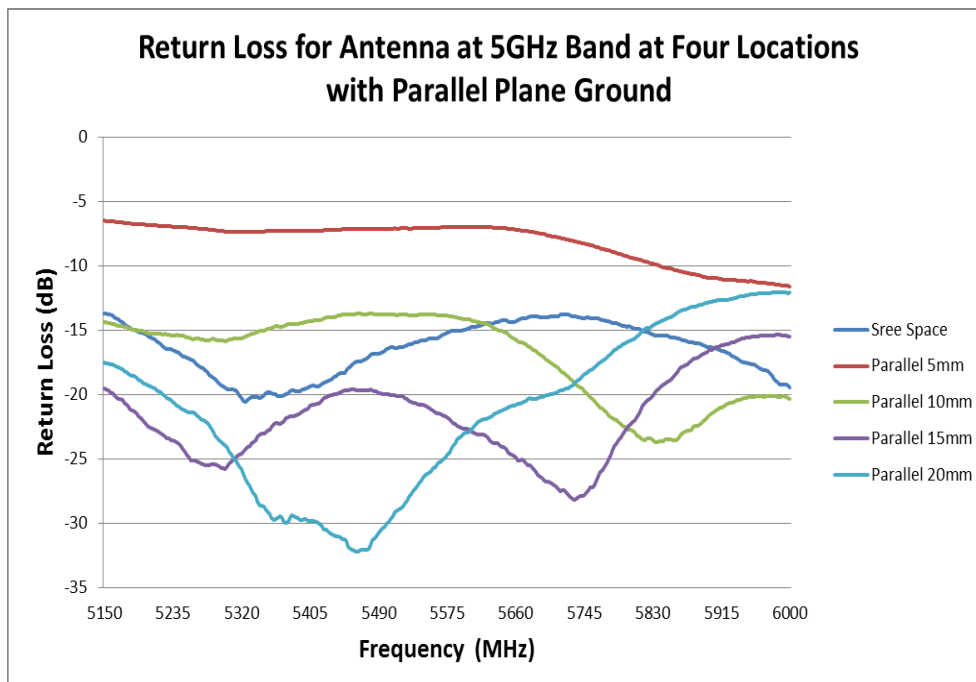

FIGURE 6.1.3 RETURN LOSS OF ANTENNA AT 5GHZ BAND AT FOUR LOCATIONS WITH PARALLEL PLANE GROUND

REVISION: G	ECR/ECN INFORMATION: EC No: 609928 DATE: 2019/02/15	TITLE: 2.4/5GHz Balance Flex Antenna Application Specification	SHEET No. 14 of 22
DOCUMENT NUMBER: AS-1461530100	CREATED / REVISED BY: Liu Hai 2019/02/15	CHECKED BY: Andy Zhang 2019/02/15	APPROVED BY: Chris Zhong 2019/02/15

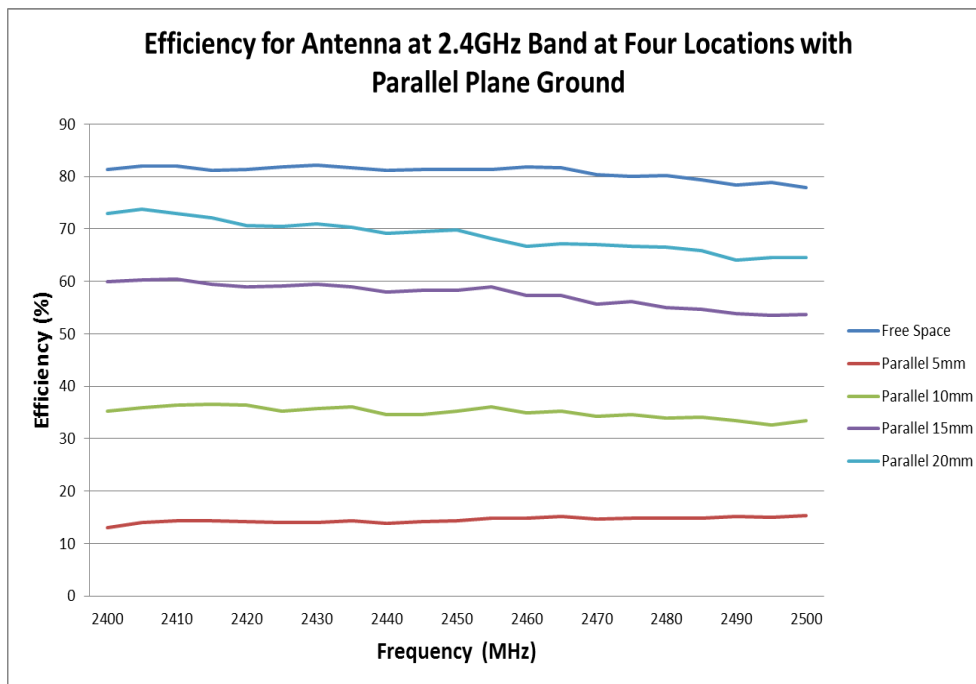

FIGURE 6.1.4 EFFICIENCY OF ANTENNA AT 2.4GHZ BAND AT FOUR LOCATIONS WITH PARALLEL PLANE GROUND

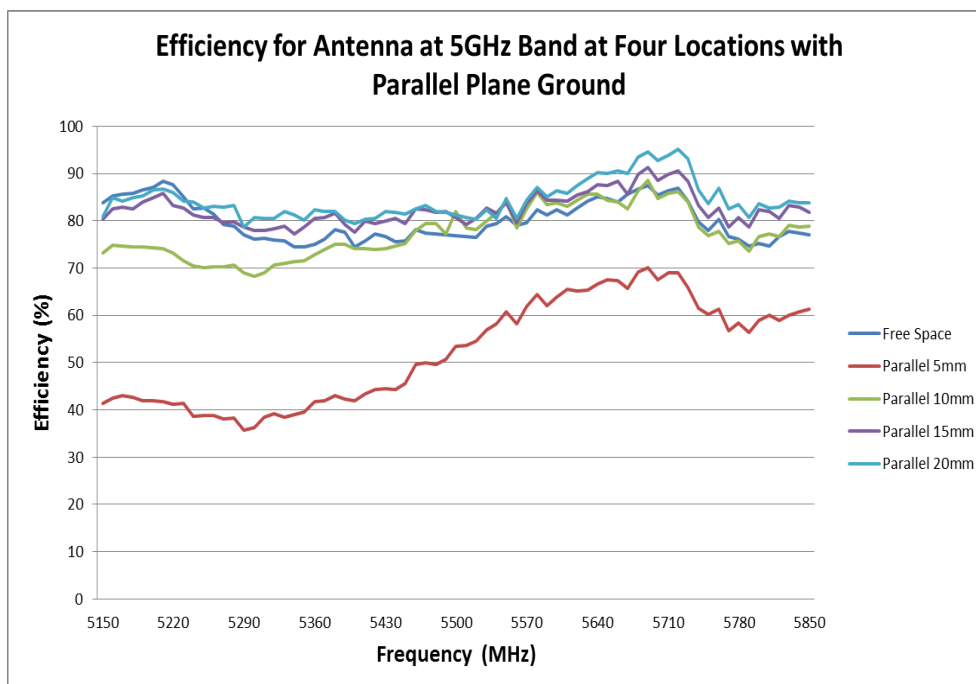

FIGURE 6.1.5 EFFICIENCY OF ANTENNA AT 5GHZ BAND AT FOUR LOCATIONS WITH PARALLEL PLANE GROUND

REVISION: G	ECR/ECN INFORMATION: EC No: 609928 DATE: 2019/02/15	TITLE: 2.4/5GHz Balance Flex Antenna Application Specification	SHEET No. 15 of 22
DOCUMENT NUMBER: AS-1461530100	CREATED / REVISED BY: Liu Hai 2019/02/15	CHECKED BY: Andy Zhang 2019/02/15	APPROVED BY: Chris Zhong 2019/02/15

6.2 ANTENNA RF PERFORMANCE AS A FUNCTION OF DIFFERENT LOCATIONS WITH VERTICAL PLANE GROUND

Four locations with vertical plane ground have been evaluated and these locations are shown in figure 6.2.1. The plane ground size is 90mm*90mm and we move the plane ground to four locations for each test. The antenna performance is better with larger distance between antenna and vertical plane ground. The minimum distance between antenna and plane ground is recommended to be 5mm to achieve acceptable RF performance.

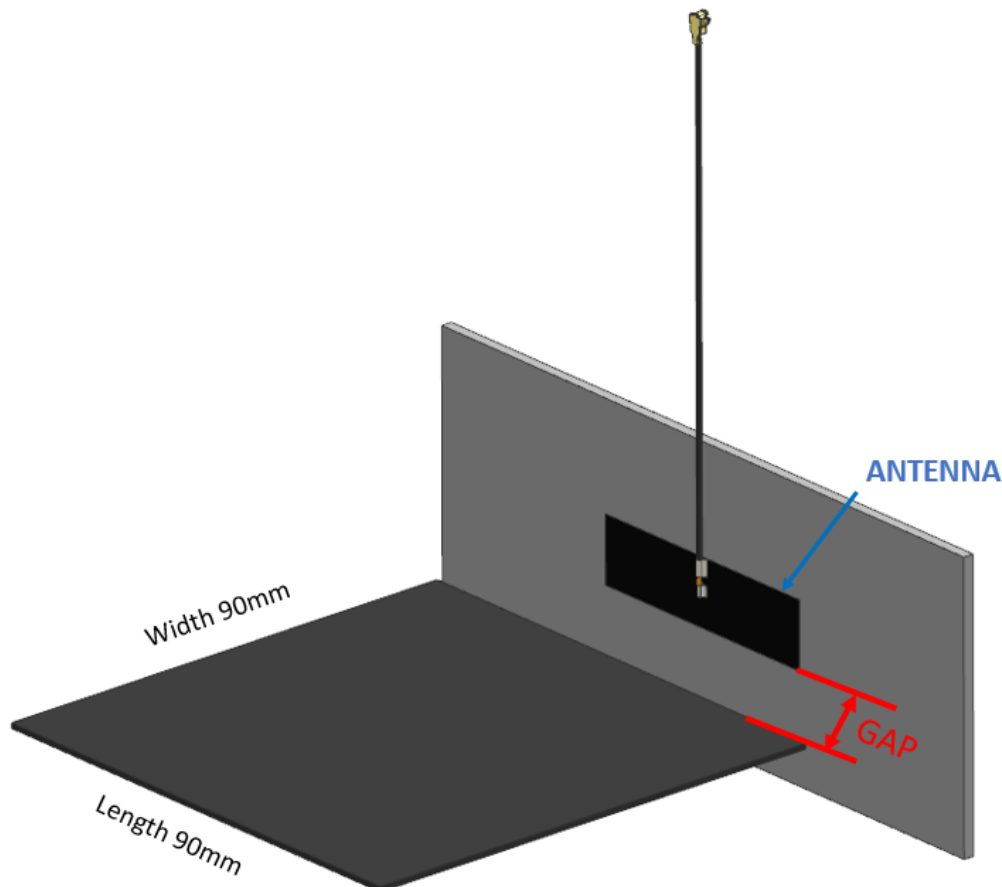

FIGURE 6.2.1 FOUR LOCATIONS WITH VERTICAL PLANE GROUND

- Ground Size: 90mm*90mm;
- Location 1: Distance between antenna and plane (GAP) ground is about 5mm;
 - Location 2: Distance between antenna and plane (GAP) ground is about 10mm;
 - Location 3: Distance between antenna and plane (GAP) ground is about 15mm;
 - Location 4: Distance between antenna and plane (GAP) ground is about 20mm.

REVISION: G	ECR/ECN INFORMATION: EC No: 609928 DATE: 2019/02/15	TITLE: 2.4/5GHz Balance Flex Antenna Application Specification	SHEET No. 16 of 22
DOCUMENT NUMBER: AS-1461530100	CREATED / REVISED BY: Liu Hai 2019/02/15	CHECKED BY: Andy Zhang 2019/02/15	APPROVED BY: Chris Zhong 2019/02/15

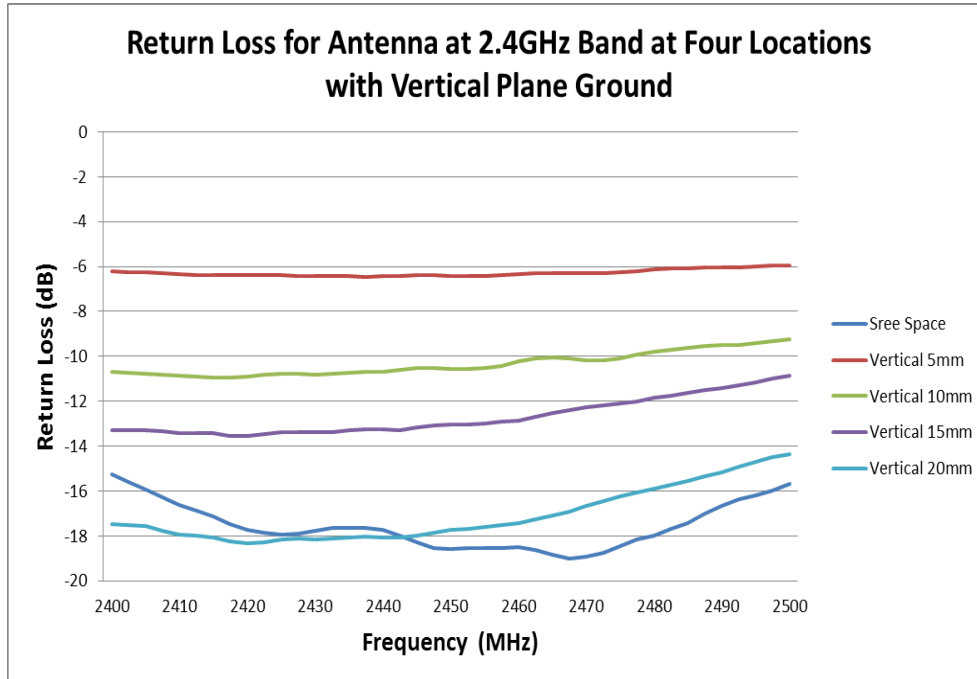

FIGURE 6.2.2 RETURN LOSS OF ANTENNA AT 2.4GHZ BAND AT FOUR LOCATIONS WITH VERTICAL PLANE GROUND

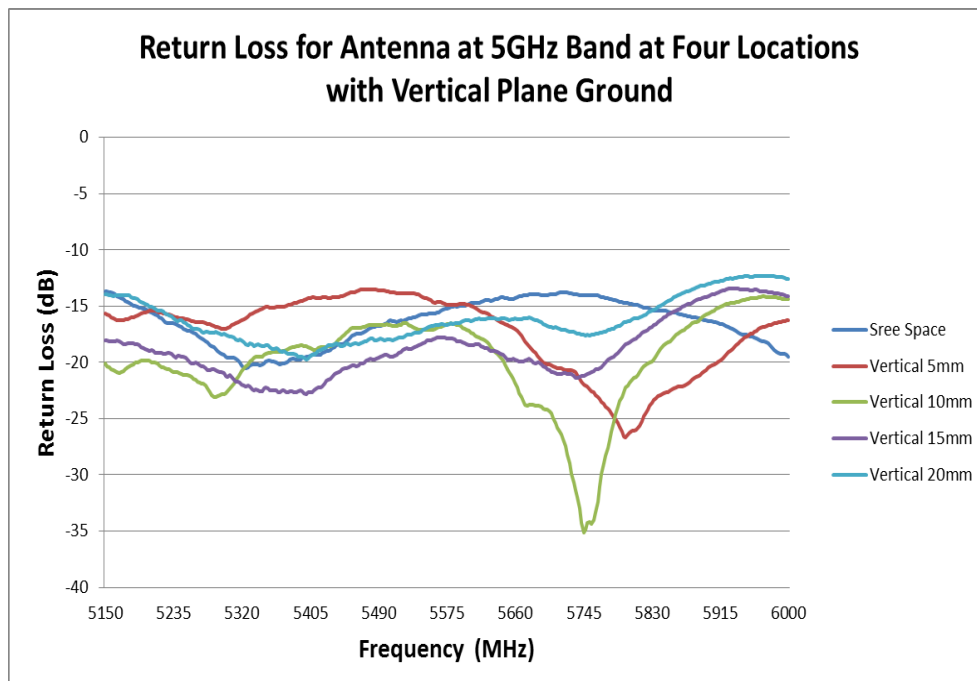

FIGURE 6.2.3 RETURN LOSS OF ANTENNA AT 5GHZ BAND AT FOUR LOCATIONS WITH VERTICAL PLANE GROUND

REVISION: G	ECR/ECN INFORMATION: EC No: 609928 DATE: 2019/02/15	TITLE: 2.4/5GHz Balance Flex Antenna Application Specification	SHEET No. 17 of 22
DOCUMENT NUMBER: AS-1461530100	CREATED / REVISED BY: Liu Hai 2019/02/15	CHECKED BY: Andy Zhang 2019/02/15	APPROVED BY: Chris Zhong 2019/02/15

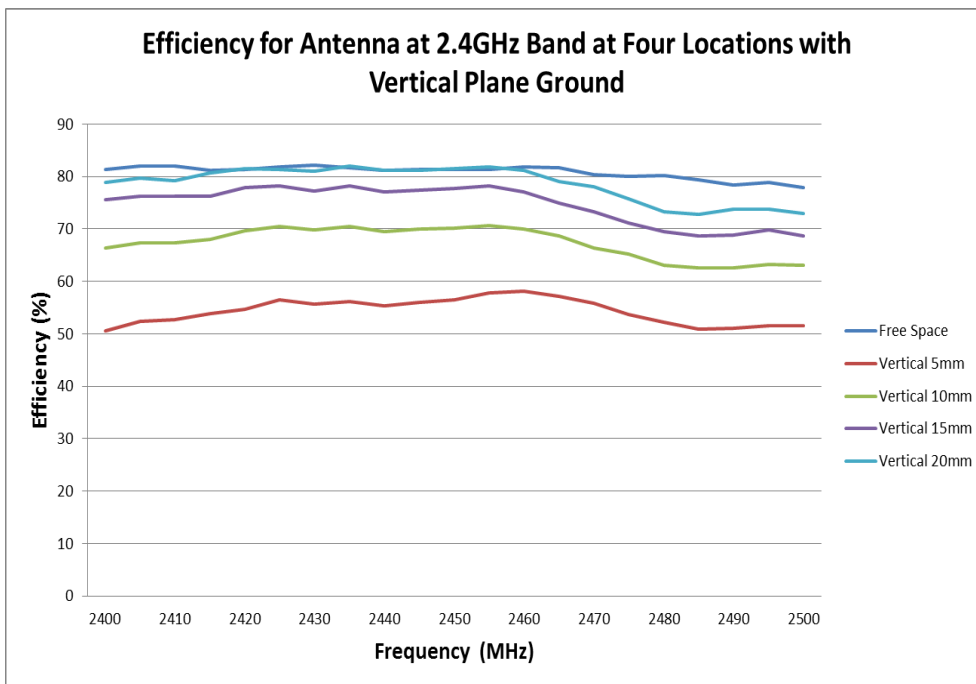

FIGURE 6.2.4 EFFICIENCY OF ANTENNA AT 2.4GHZ BAND AT FOUR LOCATIONS WITH VERTICAL PLANE GROUND

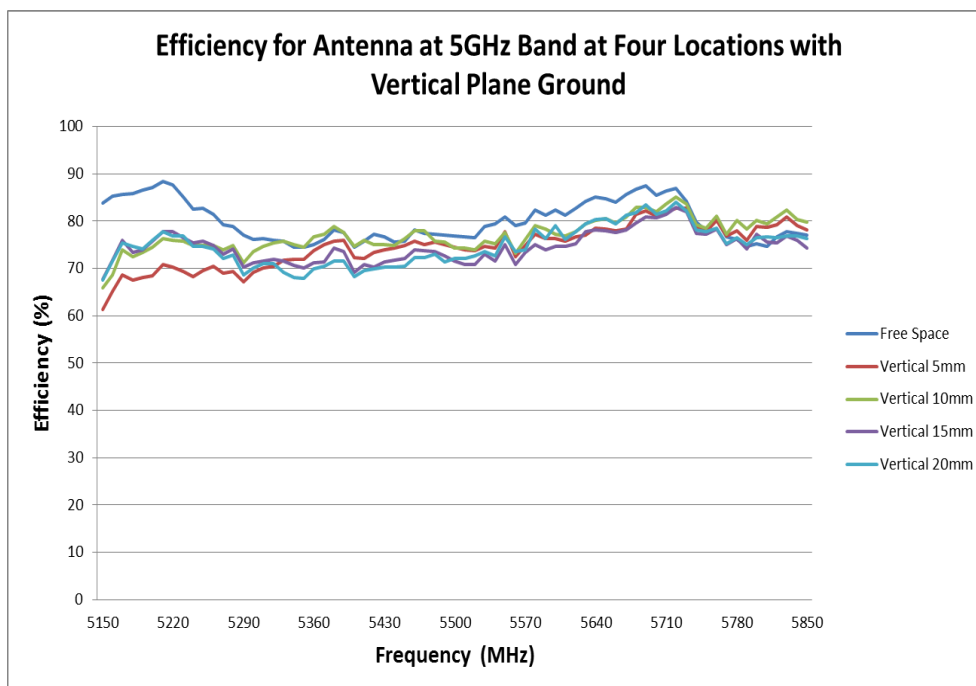

FIGURE 6.2.5 EFFICIENCY OF ANTENNA AT 5GHZ BAND AT FOUR LOCATIONS WITH VERTICAL PLANE GROUND

REVISION: G	ECR/ECN INFORMATION: EC No: 609928 DATE: 2019/02/15	TITLE: 2.4/5GHz Balance Flex Antenna Application Specification	SHEET No. 18 of 22
DOCUMENT NUMBER: AS-1461530100	CREATED / REVISED BY: Liu Hai 2019/02/15	CHECKED BY: Andy Zhang 2019/02/15	APPROVED BY: Chris Zhong 2019/02/15

6.3 ANTENNA RF PERFORMANCE AS A FUNCTION OF DIFFERENT DISTANCES WITH PARALLEL PLANE GROUND

Four locations with the parallel plane ground have been evaluated and these locations are shown in figure 6.3.1. The plane ground size is 90mm*90mm and we move the plane ground to four locations for each test. The antenna performance is better with larger distance between the antenna and the parallel plane ground. The minimum distance between the antenna and the plane ground is recommended to be 5mm to achieve acceptable RF performance.

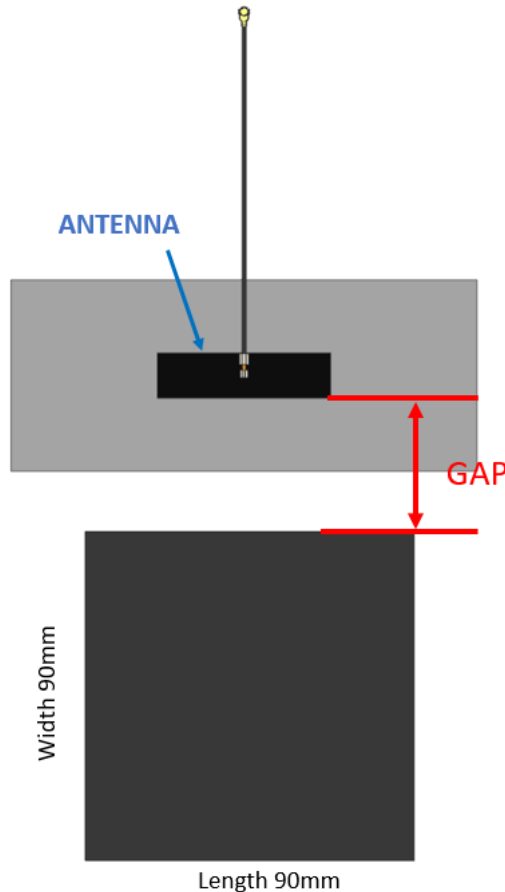

FIGURE 6.3.1 FOUR LOCATIONS WITH PARALLEL PLANE GROUND

Ground Size: 90mm*90mm;

- Location 1: Distance between antenna and plane (GAP) ground is about 5mm;
- Location 2: Distance between antenna and plane (GAP) ground is about 10mm;
- Location 3: Distance between antenna and plane (GAP) ground is about 15mm;
- Location 4: Distance between antenna and plane (GAP) ground is about 20mm.

REVISION: G	ECR/ECN INFORMATION: EC No: 609928 DATE: 2019/02/15	TITLE: 2.4/5GHz Balance Flex Antenna Application Specification	SHEET No. 19 of 22
DOCUMENT NUMBER: AS-1461530100	CREATED / REVISED BY: Liu Hai 2019/02/15	CHECKED BY: Andy Zhang 2019/02/15	APPROVED BY: Chris Zhong 2019/02/15

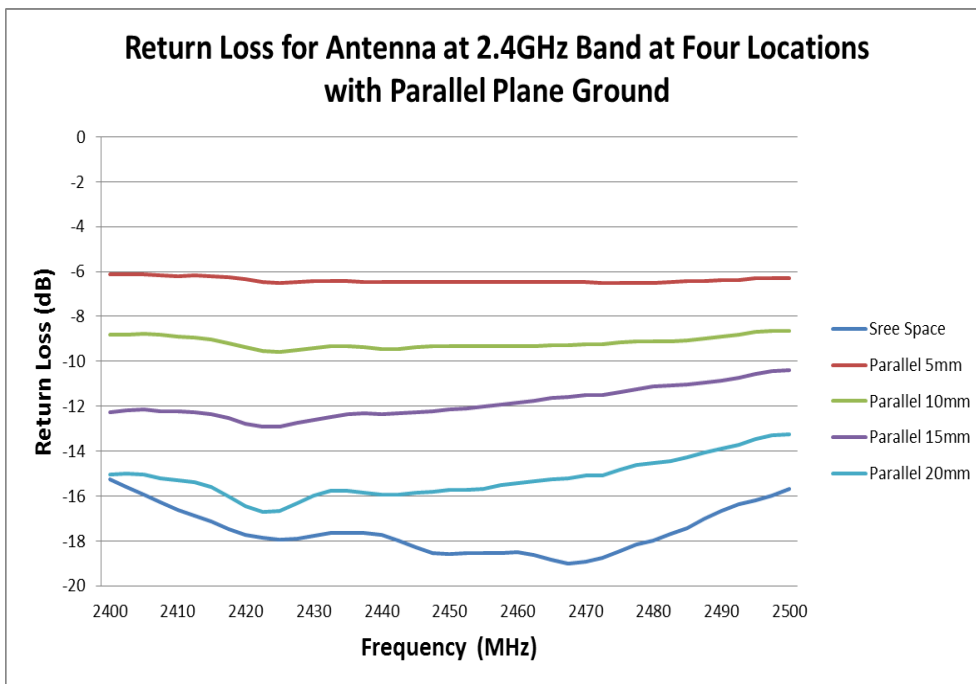

FIGURE 6.3.2 RETURN LOSS OF ANTENNA AT 2.4GHZ BAND AT FOUR LOCATIONS WITH PARALLEL PLANE GROUND

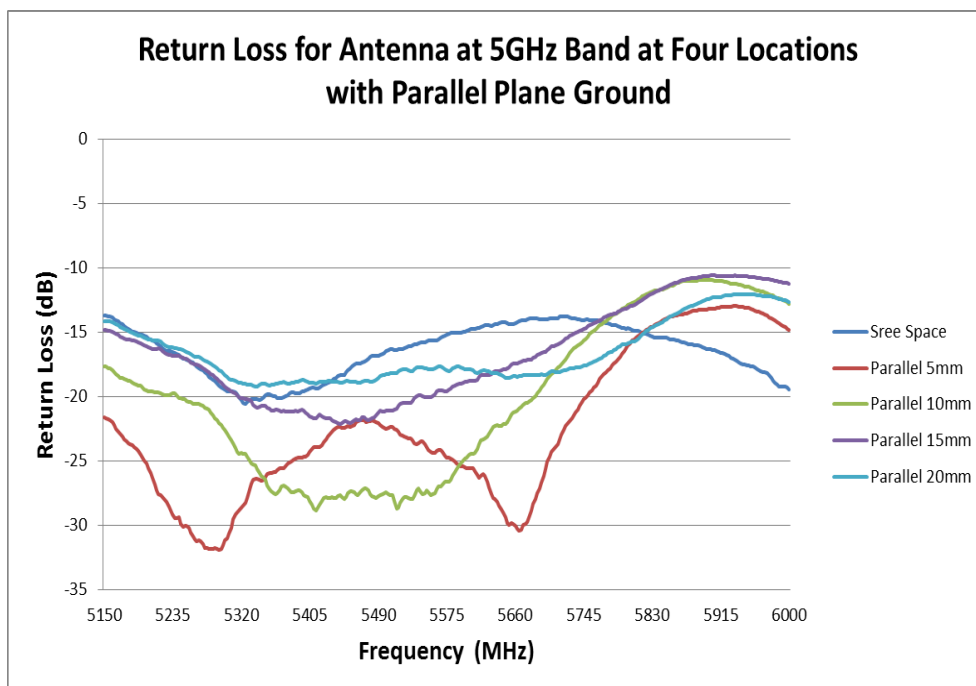

FIGURE 6.3.3 RETURN LOSS OF ANTENNA AT 5GHZ BAND AT FOUR LOCATIONS WITH PARALLEL PLANE GROUND

REVISION: G	ECR/ECN INFORMATION: EC No: 609928 DATE: 2019/02/15	TITLE: 2.4/5GHz Balance Flex Antenna Application Specification	SHEET No. 20 of 22
DOCUMENT NUMBER: AS-1461530100	CREATED / REVISED BY: Liu Hai 2019/02/15	CHECKED BY: Andy Zhang 2019/02/15	APPROVED BY: Chris Zhong 2019/02/15

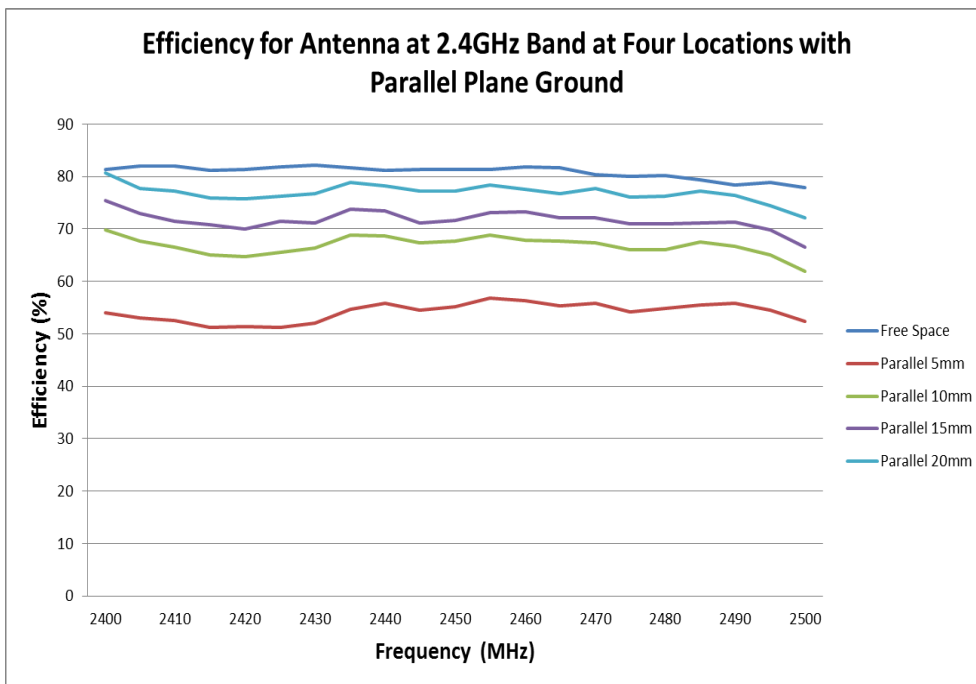

FIGURE 6.3.4 EFFICIENCY OF ANTENNA AT 2.4GHZ BAND AT FOUR LOCATIONS WITH PARALLEL PLANE GROUND

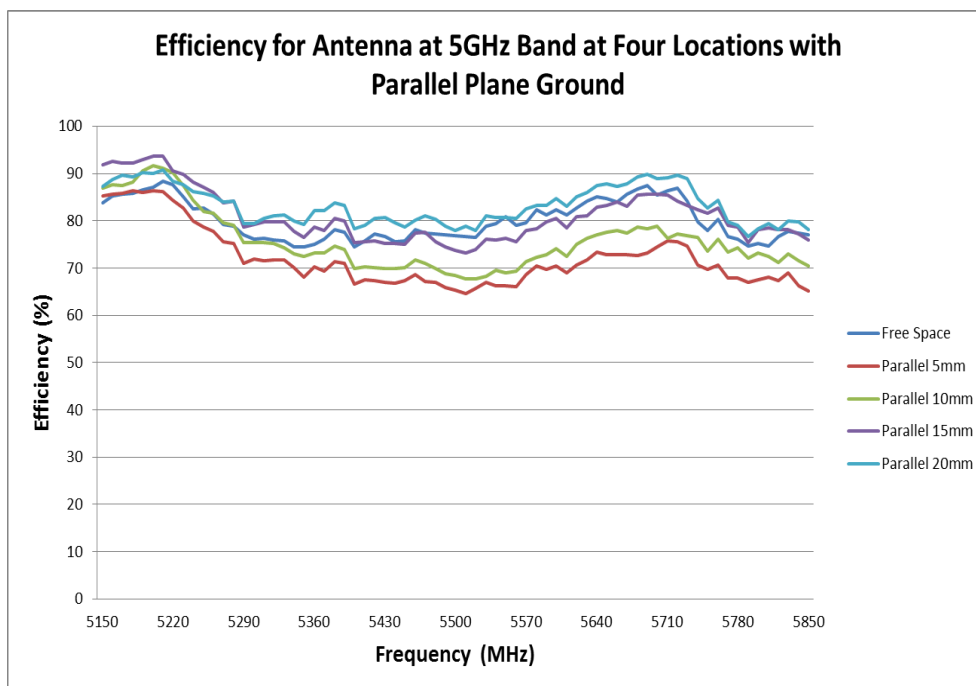

FIGURE 6.3.5 EFFICIENCY OF ANTENNA AT 5GHZ BAND AT FOUR LOCATIONS WITH PARALLEL PLANE GROUND

REVISION: G	ECR/ECN INFORMATION: EC No: 609928 DATE: 2019/02/15	TITLE: 2.4/5GHz Balance Flex Antenna Application Specification	SHEET No. 21 of 22
DOCUMENT NUMBER: AS-1461530100	CREATED / REVISED BY: Liu Hai 2019/02/15	CHECKED BY: Andy Zhang 2019/02/15	APPROVED BY: Chris Zhong 2019/02/15



APPLICATION SPECIFICATION

7.0 THE ANTENNA PERFORMANCE VARIATION WITH CABLE LENGTH

7.0.1 CABLE LOSS

ITEM	DESCRIPTION	TEST CONDITION	REQUIREMENT	
7.0.1.1	Frequency Range	2 GHz~6GHz	2GHz~3GHz	5GHz~6GHz
7.0.1.2	Attenuation	1m cable measured by VNA5071C	≤3.5dB/m	≤5.5dB/m

7.0.2 CABLE LENGTH AFFECT THE ANTENNA PERFORMANCE

Balance antenna resonance is insensitive by cable length, but the cable loss will affect the total efficiency. Refer to 7.0.1

7.0.3 FOR EXAMPLE

Base on the 100mm cable performance, we can mostly compute the 300mm cable's.

Frequency (MHz)	100mm cable		cable loss	300mm cable	
	Efficiency (dB)	Efficiency (%)		Efficiency (dB)	Efficiency (%)
	X		X-LOSS=Y	Y	
2400	-0.49	81.29	0.2m*3.5dB/m	-1.19	76.00
2420	-0.39	81.31		-1.09	77.72
2440	-0.65	81.19		-1.35	73.36
2460	-0.77	81.78		-1.47	71.31
2480	-0.69	80.27		-1.39	72.58
2500	-0.87	77.88		-1.57	69.69
5150	-0.38	83.72	0.2*5.5dB/m	-1.48	71.20
5200	-0.13	87.04		-1.23	75.33
5250	-0.33	82.70		-1.43	71.96
5300	-0.70	76.13		-1.80	66.08
5350	-0.83	74.51		-1.93	64.05
5400	-0.73	74.49		-1.83	65.58
5450	-0.66	75.84		-1.76	66.63
5500	-0.42	76.81		-1.52	70.49
5550	-0.42	80.83		-1.52	70.50
5600	-0.35	82.33		-1.45	71.67
5650	0.07	84.68		-1.03	78.93
5700	-0.20	85.43		-1.30	74.08
5750	-0.56	77.95		-1.66	68.27
5800	-0.70	75.20		-1.80	66.14
5850	-0.61	76.97		-1.71	67.51

The data is just for your reference, all accurate performance should be according to the test results in the OTA chamber

REVISION: G	ECR/ECN INFORMATION: EC No: 609928 DATE: 2019/02/15	TITLE: 2.4/5GHz Balance Flex Antenna Application Specification	SHEET No. 22 of 22
DOCUMENT NUMBER: AS-1461530100	CREATED / REVISED BY: Liu Hai 2019/02/15	CHECKED BY: Andy Zhang 2019/02/15	APPROVED BY: Chris Zhong 2019/02/15