



Part no.: 50120786
BCL 358i SM 100 D H
Stationary bar code reader



EtherNet/IP[®]



Figure can vary

Contents

- Technical data
- Dimensioned drawings
- Electrical connection
- Diagrams
- Operation and display
- Part number code
- Notes
- Accessories

Technical data

Basic data	
Series	BCL 300i
Special design	
Special design	Heating
Functions	
Functions	Alignment mode AutoConfig AutoControl AutoReflAct Code fragment technology Heating LED indicator Reference code comparison
Characteristic parameters	
MTTF	110 years
Read data	
Code types, readable	2/5 Interleaved Codabar Code 128 Code 39 Code 93 EAN 8/13 GS1 Databar Expanded GS1 Databar Limited GS1 Databar Omnidirectional UPC
Scanning rate, typical	1,000 scans/s
Bar codes per reading gate, max. number	64 Piece(s)
Optical data	
Reading distance	30 ... 290 mm
Light source	Laser , Red
Laser light wavelength	655 nm
Laser class	2 , IEC/EN 60825-1:2007
Transmitted-signal shape	Continuous
Usable opening angle (reading field opening)	60 °
Modulus size	0.2 ... 0.5 mm
Reading method	Line scanner with deflecting mirror
Beam deflection	By means of rotating polygon mirror wheel + deflecting mirror
Light beam exit	Lateral with deflecting mirror
Electrical data	
Protective circuit	Polarity reversal protection
Performance data	
Supply voltage U_B	18 ... 30 V , DC
Power consumption, max.	8 W

Inputs/outputs selectable

Output current, max.	60 mA
Number of inputs/outputs selectable	2 Piece(s)
Input current, max.	8 mA

Interface

Type	EtherNet IP
------	-------------

EtherNet IP

Function	Process
Address assignment	DHCP Manual address assignment
Switch functionality	Integrated
Transmission speed	10 Mbit/s 100 Mbit/s

Service interface

Type	USB
------	-----

USB

Function	Configuration via software
----------	----------------------------

Connection

Number of connections	1 Piece(s)
-----------------------	------------

Connection 1

Function	BUS IN Connection to device Data interface PWR / SW IN/OUT Service interface
Type of connection	Plug connector
No. of pins	32 -pin
Type	Male

Mechanical data

Design	Cubic
Dimension (W x H x L)	103 mm x 44 mm x 96 mm
Housing material	Metal , Diecast aluminum
Lens cover material	Glass
Net weight	350 g
Housing color	Black Red
Type of fastening	Dovetail grooves Fastening on back Via optional mounting device

Operation and display

Type of display	LED Monochromatic graphic display, 128 x 32 pixels
Number of LEDs	2 Piece(s)
Type of configuration	Via web browser

Environmental data

Ambient temperature, operation	0 ... 40 °C
Ambient temperature, storage	-20 ... 70 °C

Part no.: 50120786 – BCL 358i SM 100 D H – Stationary bar code reader

Relative humidity (non-condensing)	0 ... 90 %
------------------------------------	------------

Certifications

Degree of protection	IP 65
Protection class	III
Certifications	c UL US
Test procedure for EMC in accordance with standard	EN 55022 EN 61000-4-2, -3, -4, -6
Test procedure for shock in accordance with standard	IEC 60068-2-27, test Ea
Test procedure for continuous shock in accordance with standard	IEC 60068-2-29, test Eb
Test procedure for vibration in accordance with standard	IEC 60068-2-6, test Fc

Classification

Customs tariff number	84719000
eCl@ss 8.0	27280102
eCl@ss 9.0	27280102
ETIM 5.0	EC002550
ETIM 6.0	EC002550

Dimensioned drawings

All dimensions in millimeters

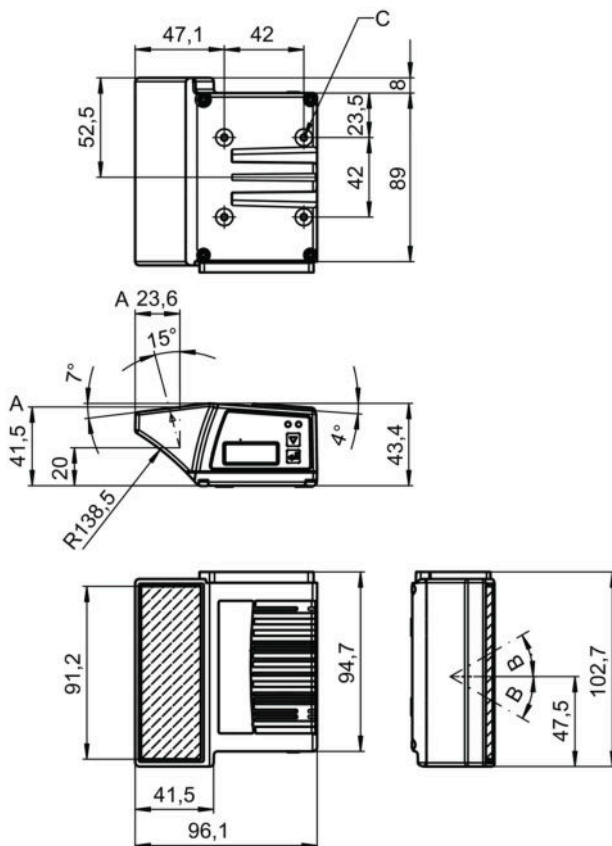

A Optical axis

B Deflection angle of the laser beam: $\pm 30^\circ$

C M4 thread (5 deep)

Electrical connection

Connection 1	
Function	BUS IN Connection to device Data interface PWR / SW IN/OUT Service interface
Type of connection	Plug connector
No. of pins	32 -pin
Type	Male

Diagrams

Reading field curve

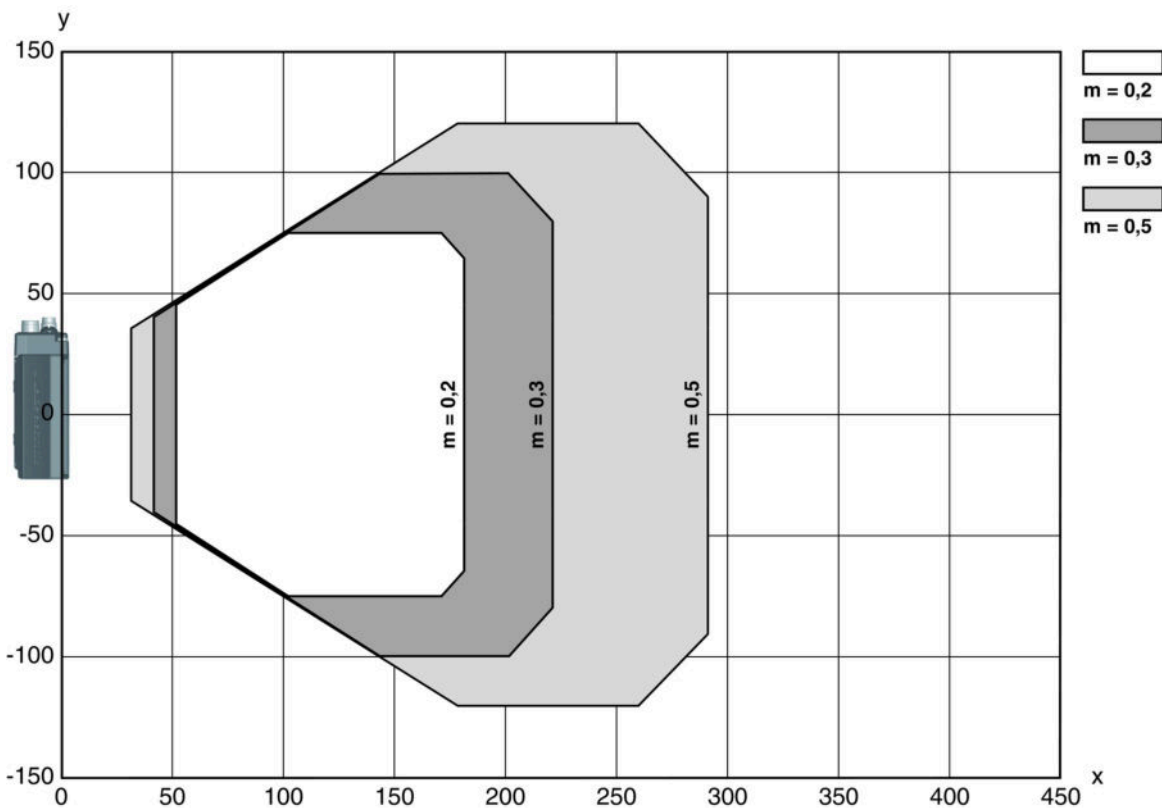

x Reading field distance [mm]
y Reading field width [mm]

Operation and display

LEDs

LED	Display	Meaning	
1	PWR	Green, flashing	Device ok, initialization phase
		Green, continuous light	Device OK
		Green, briefly off - on	Reading successful
		green, briefly off - briefly red - on	Reading not successful
		Orange, continuous light	Service mode
		Red, flashing	Device OK, warning set
		Red, continuous light	Error, device error
2	NET	Green, flashing	Initialization
		Green, continuous light	Bus operation ok
		Red, flashing	Communication error
		Red, continuous light	Bus error

Part number code

 Part designation: **BCL XXXX YYZ AAA BB CCCC**

BCL	Operating principle: BCL: bar code reader
XXXX	Series/interface (integrated fieldbus technology): 300i: RS 232 / RS 422 (stand-alone) 301i: RS 485 (multiNet slave) 304i: PROFIBUS DP 308i: EtherNet TCP/IP, UDP 348i: PROFINET RT 358i: EtherNet/IP
YY	Scanning principle: S: line scanner (single line) R1: line scanner (raster) O: oscillating-mirror scanner (oscillating mirror)
Z	Optics: N: High Density (close) M: Medium Density (medium distance) F: Low Density (remote) L: Long Range (very large distances) J: ink-jet (depending on the application)
AAA	Beam exit: 100: lateral 102: front
BB	Special equipment: D: with display H: with heating DH: optionally with display and heating P: plastic exit window
CCCC	Functions: F007: optimized process data structure

Note

 A list with all available device types can be found on the Leuze website at www.leuze.com.

Notes

Observe intended use!

- This product is not a safety sensor and is not intended as personnel protection.
- The product may only be put into operation by competent persons.
- Only use the product in accordance with its intended use.

WARNING! LASER RADIATION – CLASS 2 LASER PRODUCT

Do not stare into beam!

The device satisfies the requirements of IEC 60825-1:2007 (EN 60825-1:2007) safety regulations for a product of **laser class 2** as well as the U.S. 21 CFR 1040.10 regulations with deviations corresponding to "Laser Notice No. 50" from June 24, 2007.

- Never look directly into the laser beam or in the direction of reflected laser beams! If you look into the beam path over a longer time period, there is a risk of injury to the retina.
- Do not point the laser beam of the device at persons!
- Interrupt the laser beam using a non-transparent, non-reflective object if the laser beam is accidentally directed towards a person.
- When mounting and aligning the device, avoid reflections of the laser beam off reflective surfaces!
- CAUTION! Use of controls or adjustments or performance of procedures other than specified herein may result in hazardous light exposure.
- Observe the applicable statutory and local laser protection regulations.
- The device must not be tampered with and must not be changed in any way.
There are no user-serviceable parts inside the device.
Repairs must only be performed by Leuze electronic GmbH + Co. KG.

NOTE

Affix laser information and warning signs!

Laser information and warning signs are affixed to the device. In addition, self-adhesive laser information and warning signs (stick-on labels) are supplied in several languages.

- Affix the laser information sheet to the device in the language appropriate for the place of use. When using the device in the US, use the stick-on label with the "Complies with 21 CFR 1040.10" note.
- Affix the laser information and warning signs near the device if no signs are attached to the device (e.g. because the device is too small) or if the attached laser information and warning signs are concealed due to the installation position.
- Affix the laser information and warning signs so that they are legible without exposing the reader to the laser radiation of the device or other optical radiation.

Accessories



Connection technology - Connection cables

	Part no.	Designation	Article	Description
	50132079	KD U-M12-5A-V1-050	Connection cable	Connection 1: Connector, M12, Axial, Female, A-coded, 5 -pin Connection 2: Open end Shielded: No Cable length: 5,000 mm Sheathing material: PVC

Part no.: 50120786 – BCL 358i SM 100 D H – Stationary bar code reader

	Part no.	Designation	Article	Description
	50135074	KS ET-M12-4A-P7-050	Connection cable	Suitable for interface: Ethernet Connection 1: Connector, M12, Axial, Male, D-coded, 4 -pin Connection 2: Open end Shielded: Yes Cable length: 5,000 mm Sheathing material: PUR

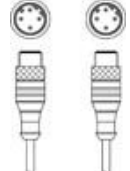
Connection technology - Interconnection cables

	Part no.	Designation	Article	Description
	50117011	KB USB A - USB miniB	Service line	Suitable for interface: USB Connection 1: USB Connection 2: USB Shielded: Yes Cable length: 1,500 mm Sheathing material: PVC
	50137078	KSS ET-M12-4A-M12-4A-P7-050	Interconnection cable	Suitable for interface: Ethernet Connection 1: Connector, M12, Axial, Male, D-coded, 4 -pin Connection 2: Connector, M12, Axial, Male, D-coded, 4 -pin Shielded: Yes Cable length: 1,000 mm Sheathing material: PUR
	50135081	KSS ET-M12-4A-RJ45-A-P7-050	Interconnection cable	Suitable for interface: Ethernet Connection 1: Connector, M12, Axial, Male, D-coded, 4 -pin Connection 2: RJ45 Shielded: Yes Cable length: 5,000 mm Sheathing material: PUR

Mounting technology - Mounting brackets

	Part no.	Designation	Article	Description
	50121433	BT 300 W	Mounting device	Contains: 4x M4 x 10 screw, 4x position washers, 4x lock washers Design of mounting device: Angle, L-shape Fastening, at system: Through-hole mounting Mounting bracket, at device: Screw type Type of mounting device: Adjustable Material: Metal

Mounting technology - Rod mounts

	Part no.	Designation	Article	Description
	50121435	BT 56 - 1	Mounting device	Functions: Static applications Design of mounting device: Mounting system Fastening, at system: For 12 mm rod, For 14 mm rod, For 16 mm rod Mounting bracket, at device: Clampable Material: Metal Tightening torque of the clamping jaws: 8 N·m

Part no.: 50120786 – BCL 358i SM 100 D H – Stationary bar code reader





Mounting technology - Other

	Part no.	Designation	Article	Description
	50124941	BTU 0300M-W	Mounting device	Fastening, at system: Through-hole mounting Mounting bracket, at device: Clampable, Groove mounting, Suited for M4 screws Material: Metal

Reflective tapes for standard applications

	Part no.	Designation	Article	Description
	50106119	REF 4-A-100x100	Reflective tape	Design: Rectangular Reflective surface: 100 mm x 100 mm Material: Plastic Chemical designation of the material: PMMA Fastening: Self-adhesive

Services

	Part no.	Designation	Article	Description
	S981020	CS30-E-212	Hourly rate for "Configuration"	Details: Compilation of the application data, selection and suggestion of suitable sensor system, drawing prepared as assembly sketch. Conditions: Completed questionnaire or project specifications with a description of the application have been provided. Restrictions: Travel and accommodation charged separately and according to expenditure.
	S981014	CS30-S-110	Start-up support	Details: Performed at location of customer's choosing, duration: max. 10 hours. Conditions: Devices and connection cables are already mounted, price not including travel costs and, if applicable, accommodation expenses. Restrictions: No mechanical (mounting) and electrical (wiring) work performed, no changes (attachments, wiring, programming) to third-party components in the nearby environment.
	S981019	CS30-T-110	Product training	Details: Location and content to be agreed upon, duration: max. 10 hours. Conditions: Price not including travel costs and, if applicable, accommodation expenses. Restrictions: Travel costs and accommodation expenses charged separately and according to expenditure.
	S981021	CS30-V-212	Hourly rate for "Bar code qualification"	Details: REA evaluation with creation of a test report, evaluation of the code quality. Conditions: Original bar codes to be provided by the client.

Note

A list with all available accessories can be found on the Leuze electronic website in the Download tab of the article detailed page.