

"Schutzvermerk nach DIN ISO 16016 beachten" "Please pay attention to copyright note DIN ISO 16016"

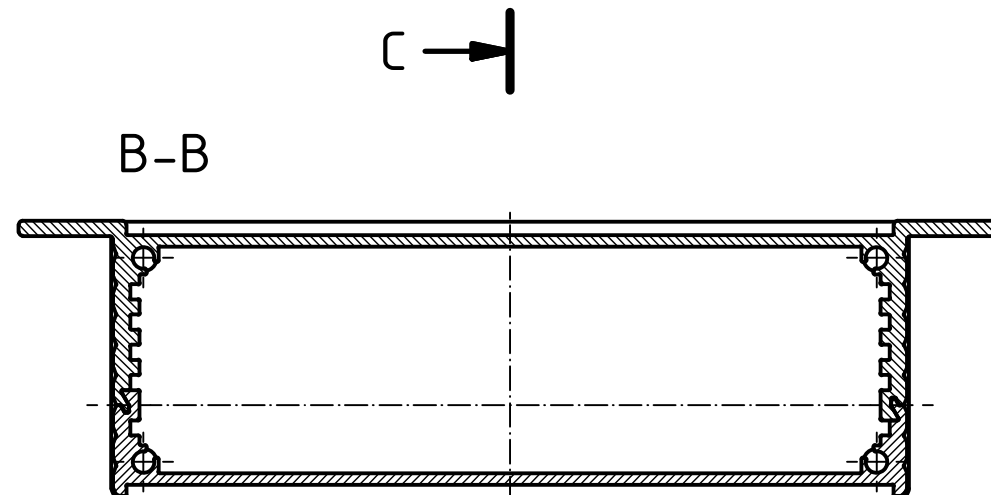

Maßstab/ Scale: 1:1

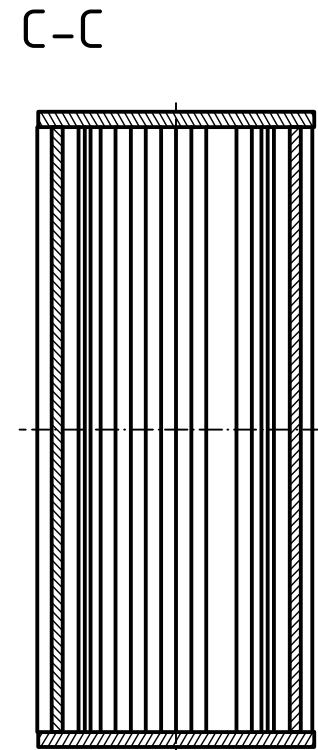
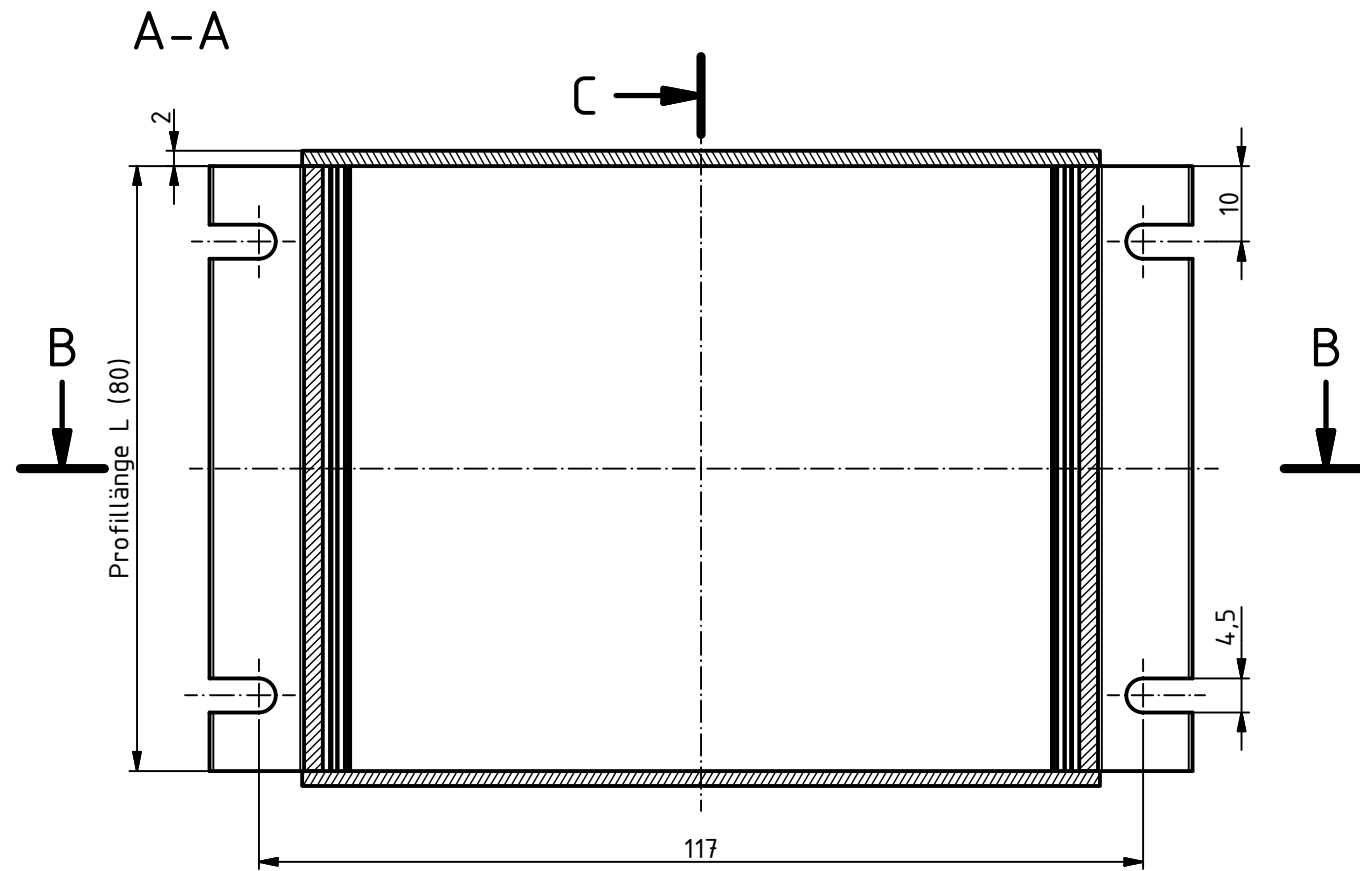
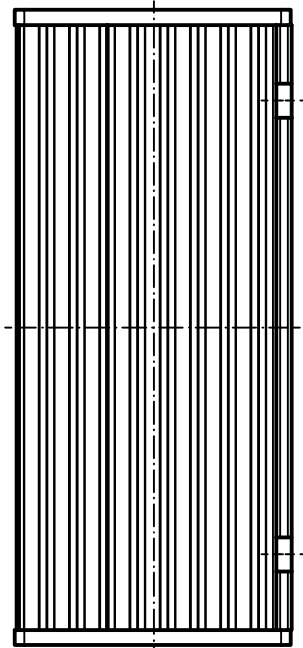
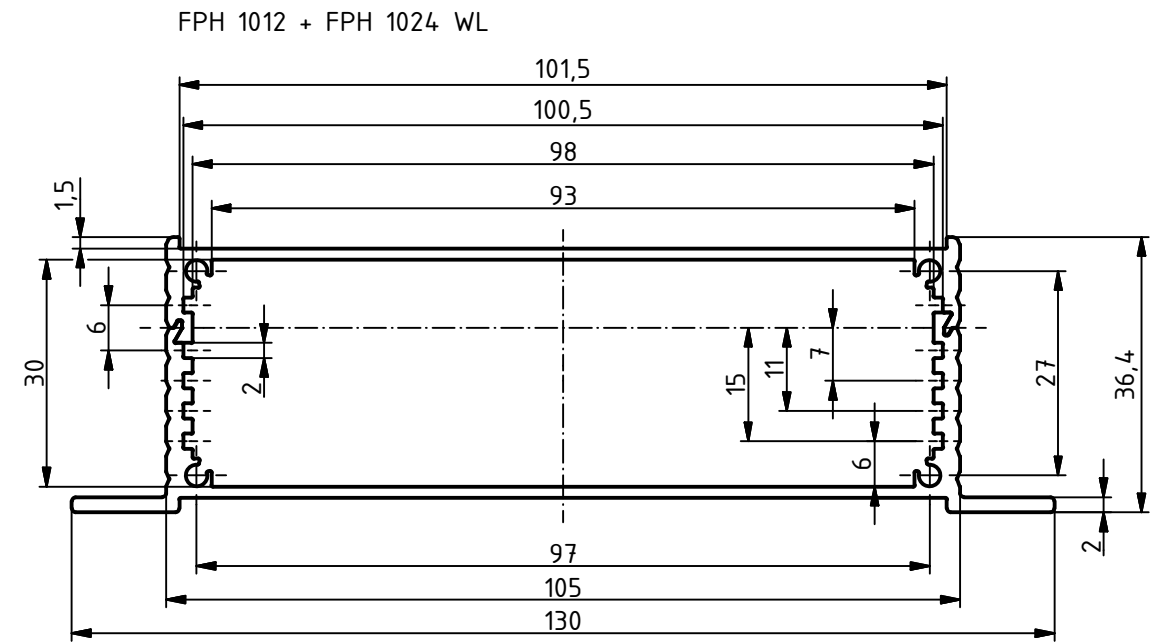
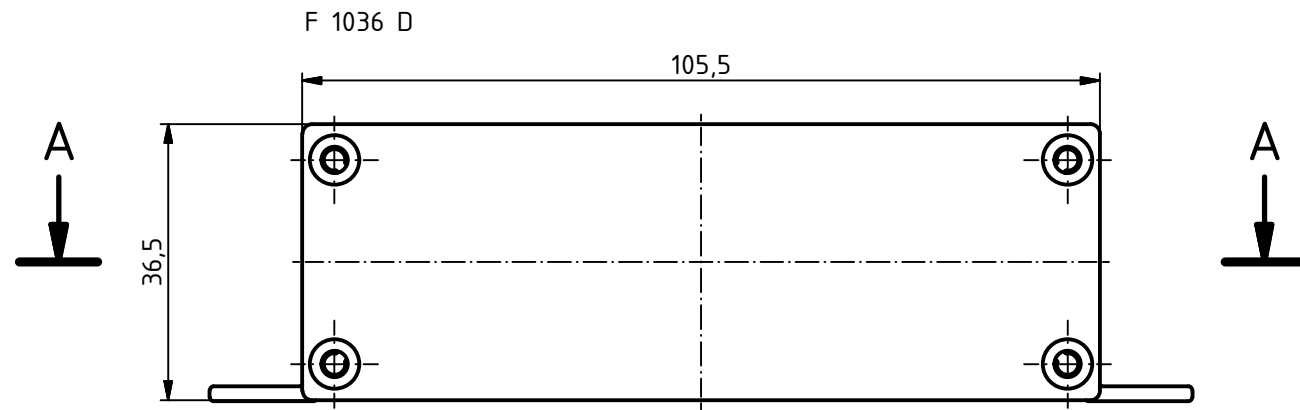
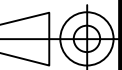

Zeichnungs-Nr. / Drawing-No.:

Artikel / Article:
FiloTec m. Deckel
FPH 1012/1024 WL+F 1036 D
Katalogzeichnung

Ä.Nr./
Alt.No.:

Datum/
Date:



DISK: 97216080.H_F 1036-80 WL.idw
Datum/Date: 23.05.2016 AR