

DALI SENSOR LS/PD CI G2

DALI SENSOR LS/PD CI G2 | Sensors



Product family features

- Light and presence sensor for ceiling integration
- Presence detection via passive IR element
- Light sensor operating range: 20...800 lx (measured at sensor)
- Mounting height: 2...5 m
- Function indicator with two-color LED
- Ceiling installation adapter

Product family benefits

- Flat design, very small structural height
- Simple and fast installation via wire springs
- DALI-2 certified
- DALI Bus powered (No mains connection necessary)
- Multiple sensors connectable to the same DALI line
- Presence detection angle adjustable between 40...90° via integrated shutters
- Integretable in light- and building management systems supporting DALI-2 sensors

Areas of application

- Suitable for indoor applications
- Individual offices
- Open-plan offices
- Classrooms
- Conference rooms
- Corridors

Product datasheet

Technical data

Electrical data

Required DALI current (typical)	6 mA
Peak DALI current	16 mA
Maximum start-up time (DALI)	600 ms

Dimensions & weight

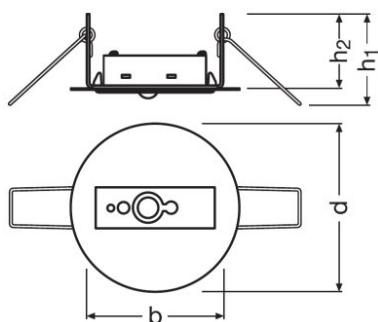

Length	80.0 mm
Mounting hole spacing, diagonal	73 mm
Product weight	95.00 g

Temperatures & operating conditions

Ambient temperature range	-20...+50 °C
---------------------------	--------------

Capabilities

Dimmable	No
Dimming interface	DALI-2
Maximum installation height	5 m
Detection area	7 m ²
Detection angle	40...90 °
Operating range, light sensor	20...800 lx
Type of installation	Ceiling integration

Certificates & standards

Type of protection	IP20
--------------------	------

Logistical data

Commodity code	903180800000
----------------	--------------

Product datasheet







Environmental information

Information according Art. 33 of EU Regulation (EC) 1907/2006 (REACH)	
Date of Declaration	30-08-2022
Primary Article Identifier	4062172072083
Candidate List Substance 1	Lead titanium zirconium oxide
CAS No. of substance 1	12626-81-2
Candidate List Substance 2	Lead
CAS No. of substance 2	7439-92-1
Safe Use Instruction	The identification of the Candidate List substance is sufficient to allow safe use of the article.
Declaration No. in SCIP database	c9ced6be-b255-4104-af21-79b1483a2d33

Equipment / Accessories

- Suitable for many OSRAM DALI control systems

Download Data

File	
	User instruction DALI2 SENSOR LSPD CI
	Declarations of conformity DALI G2 Sensor Coupler CE 4202657 03 061020
	CAD data DALI SENSOR LS PD CI G2 IGS 110820
	CAD data DALI SENSOR LS PD CI G2 STEP 110820
	CAD Data 2-dim DALI SENSOR LS PD CI G2 2PDF 110820
	CAD data 3-dim DALI SENSOR LS PD CI G2 CAD3PDF 110820

Logistical Data

Product code	Product description	Packaging unit (Pieces/Unit)	Dimensions (length x width x height)	Volume	Gross weight
4062172072083	DALI SENSOR LS/PD CI G2	Shipping carton box 10	217 mm x 217 mm x 180 mm	8.48 dm ³	1229.00 g

Product datasheet

Logistical Data

The mentioned product code describes the smallest quantity unit which can be ordered. One shipping unit can contain one or more single products. When placing an order, for the quantity please enter single or multiples of a shipping unit.

Disclaimer

Subject to change without notice. Errors and omission excepted. Always make sure to use the most recent release.