

M12 MALE 90° / M12 FEMALE 0°

PUR 4X0.34 black UL/CSA, drag ch 10m

Male 90° to female straight

M12 - M12, 4-pole

Art.-No. 7005 - M12 Lite - (plastic hexagonal screw) on request

Plastic housings with good resistance against chemicals and oils. The resistance to aggressive media should be individually tested for your application. Further details on request. Further cable lengths on request.

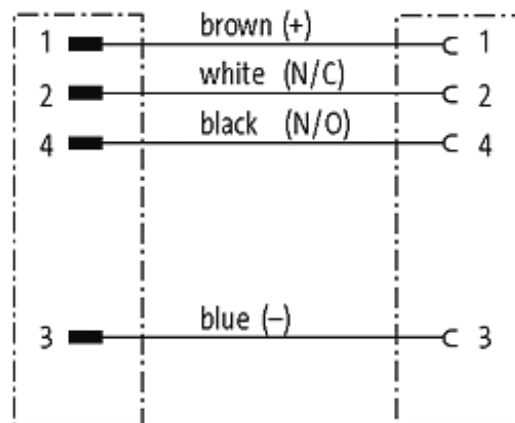
[Link to Product](#)**Illustration**

Male

Female

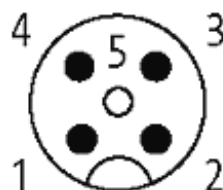

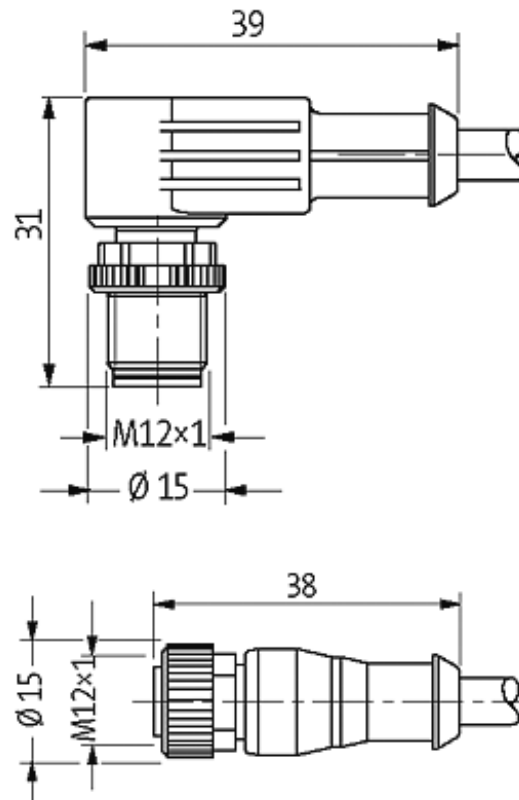

Product may differ from Image

Approvals



* only for products with UL/CSA approved cable

Form

40201

Technical Data

| | |
|-------------------------------|---|
| Operating voltage | max. 250 V AC/DC |
| Operating current per contact | max. 4 A |
| Locking of ports | Screw thread M12 × 1 mm (recommended torque 0.6 Nm) self-securing |
| Protection | IP67 inserted and tightened (EN 60529) |

Cables

| | |
|-----------------------|--------------------------|
| Cable number | 634 |
| No./diameter of wires | 4 × 0.34 mm ² |
| Wire isolation | PP (br, wh, bl, bk) |
| C-track properties | 5 Mio. |
| Torsion | 2 Mio. ± 180°/m |
| Jacket Color | black |

The information in this brochure has been compiled with the utmost care.

Liability for the correctness completeness and topicality of the information is restricted to gross negligence. Version: 05/15

| | |
|-----------------------------|----------------|
| Shore hardness outer jacket | 90 ± 5A |
| Material (jacket) | PUR (UL/CSA) |
| Outer diameter | approx. 4.7 mm |
| Bend radius (fixed) | 5 × outer Ø |
| Bend radius (moving) | 10 × outer Ø |
| Temperature range (fixed) | -40...+80 °C |
| Temperature range (mobile) | -25...+80 °C |

Commercial data

| | |
|------------------------|----------|
| country of origin | DE |
| customs tariff number | 85444290 |
| minimum order quantity | 1 |