

Electronics design with the Voltera V-One.

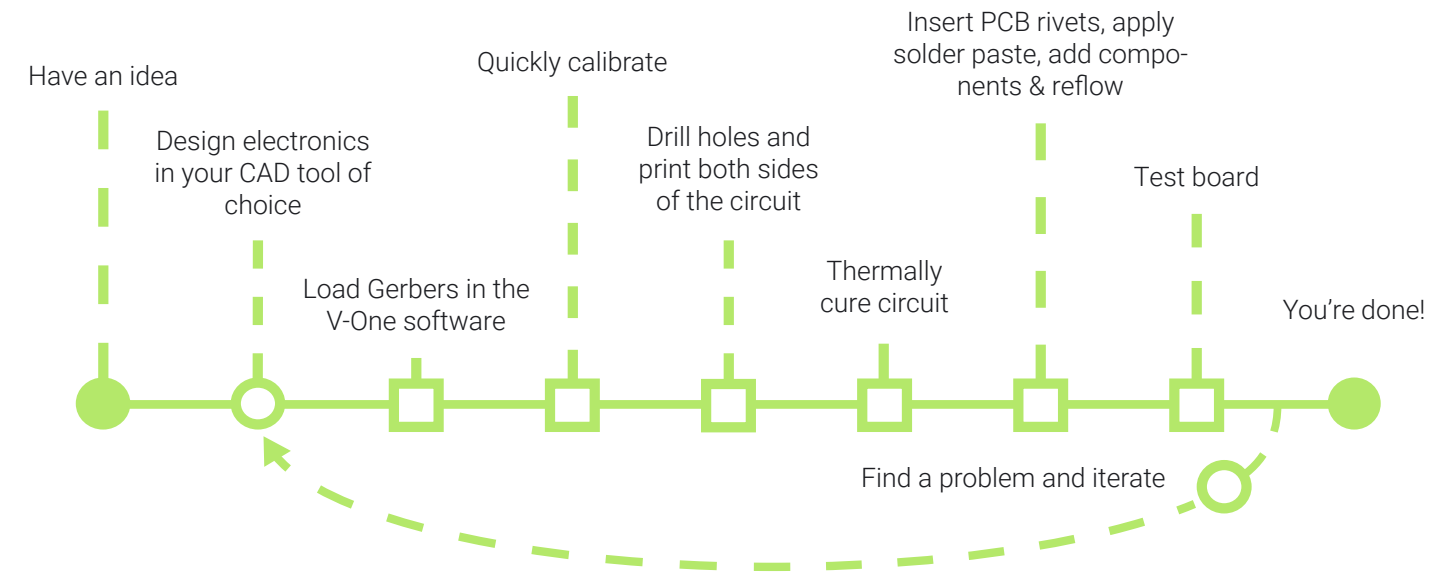

The V-One is a desktop, multi-functional circuit board printer.

Save time and money with desktop PCB manufacturing.

If you had access to your own PCB factory – 24 hours a day, seven days a week – that sat on your desktop and printed custom circuits on a variety of substrates with a zero-day lead time, what could you make? How fast could you make it?

Those are the questions that inspired us to create the V-One Desktop PCB Printer.

The V-One can print traces of conductive ink, drill through-holes and vias, precisely dispense solder paste and reflow components with a built-in heater.

The Voltera V-One is an all-in-one solution for board fabrication that keeps your development cycle tight and your IP completely in-house.

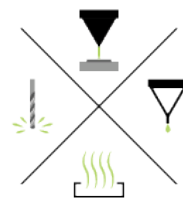

All-in-one circuit design

Print conductive traces, drill through-holes, dispense solder paste and reflow components on your desktop; at home, the lab or the office.



Easy experience

Using the V-One is a breeze. From simple software with in-app video instructions to magnetic attachments, it's as easy to use as an iPad app.

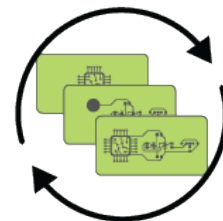

Rapid iteration

Save money and shave weeks off your product development. Test your prototype board the same day you finish the design and export the Gerber file.

Take control of your product development cycle by printing your own circuit boards.

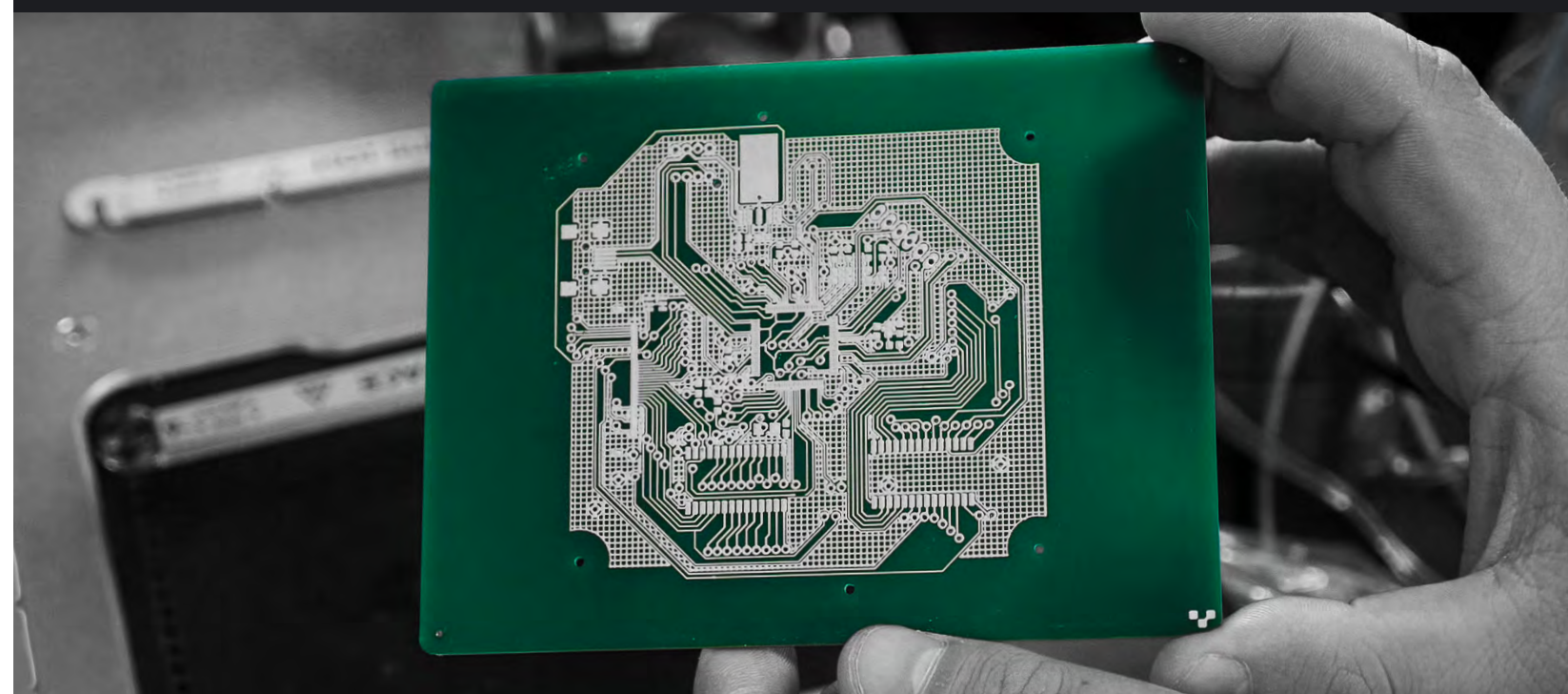

A 'graphical LCD and touchscreen overlay controller' printed and cured on an FR4 rigid substrate by the Voltera V-One.

Design. Print. Test. Repeat.

The Voltera V-One is a “compile” button for hardware designers and engineers.

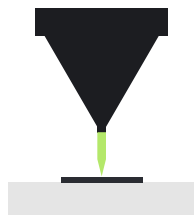

Align

Align quickly using Voltera's smart height probe and existing board features as fiducials for XY alignment.



Drill

Designed to be compact, the V-One drills through-holes and vias at 13,000 RPM with a 3 mil runout.



Dispense

Deposit ink and solder paste on printed or factory-fabbed boards with a 0.65mm pin-to-pin pitch.



Reflow

Cure ink and reflow with one click using pre-registered heating profiles on the 550W heater.

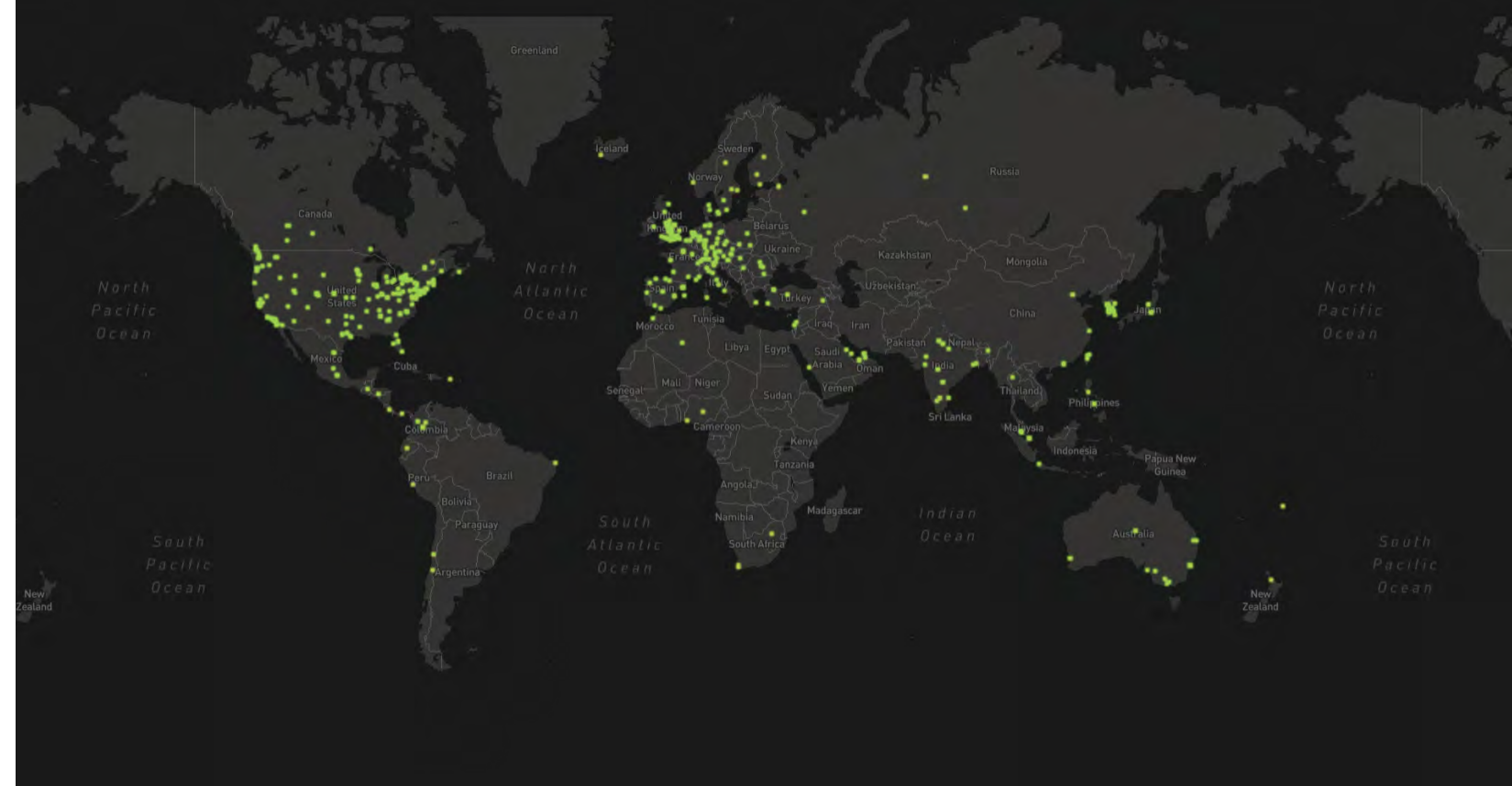

Teams at leading companies like Apple, Intel, Seimens, Bosch, NVIDIA, GM, HP, Raytheon, Procter & Gamble and more use the V-One to rapidly design hardware.

A global community of users.

Join the engineers around the world innovating with the V-One.

We have shipped thousands V-One's to over 60 countries. With over a dozen resellers on nearly every continent, it's easy to purchase, restock or find support for your printer. The affordable price of V-One and consumables make it easy on your budget and easy to purchase online (so you only need to speak to our sales team if you want)

step-by-step videos built into the app, the Voltera V-One gets you up and running quickly and can be mastered in minutes.

Set up is simple: unbox, plug in, download the free software and begin. No logistics coordination or on-site install. With multilanguage support, online support docs and

Built to last, the V-One is easy to clean and keeping operational; no day-long downtime for cleaning or calls for annual maintenance. It is shareable – one or multiple product teams can have access – and fast enough that you'll likely never have scheduling conflicts.



Save money

The V-One lets you create working prototypes without the hassle or cost of outsourcing PCB fabrication overseas.

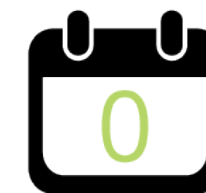

0-day lead time

Bring products to market faster, try out more ideas at the prototype phase and rapidly iterate on full boards or circuit modules.



Online help center

Searchable guides, safety data sheets, getting started projects, video tutorials & educational content. All with technical support staff a message away.

Along with printing custom circuit traces, the Voltera V-One can precisely dispense solder paste onto printed or factory-fabbed boards for rapid population of surface-mount components.

What's in the box?

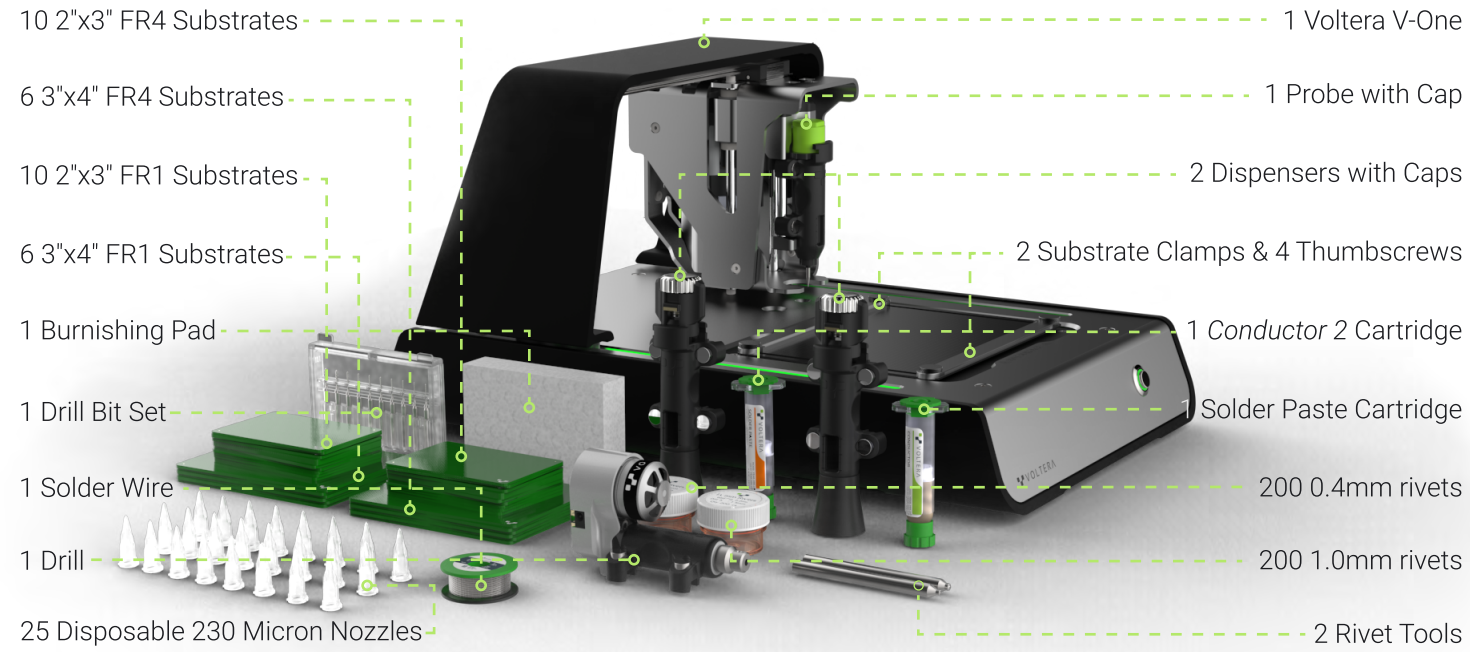

(Not pictured) 1 Sacrificial Layer 1 Hello World Starter Kit 1 Punk Console Starter Kit 1 Voltera Anti-Static Tweezers 1 Set of Safety Glasses

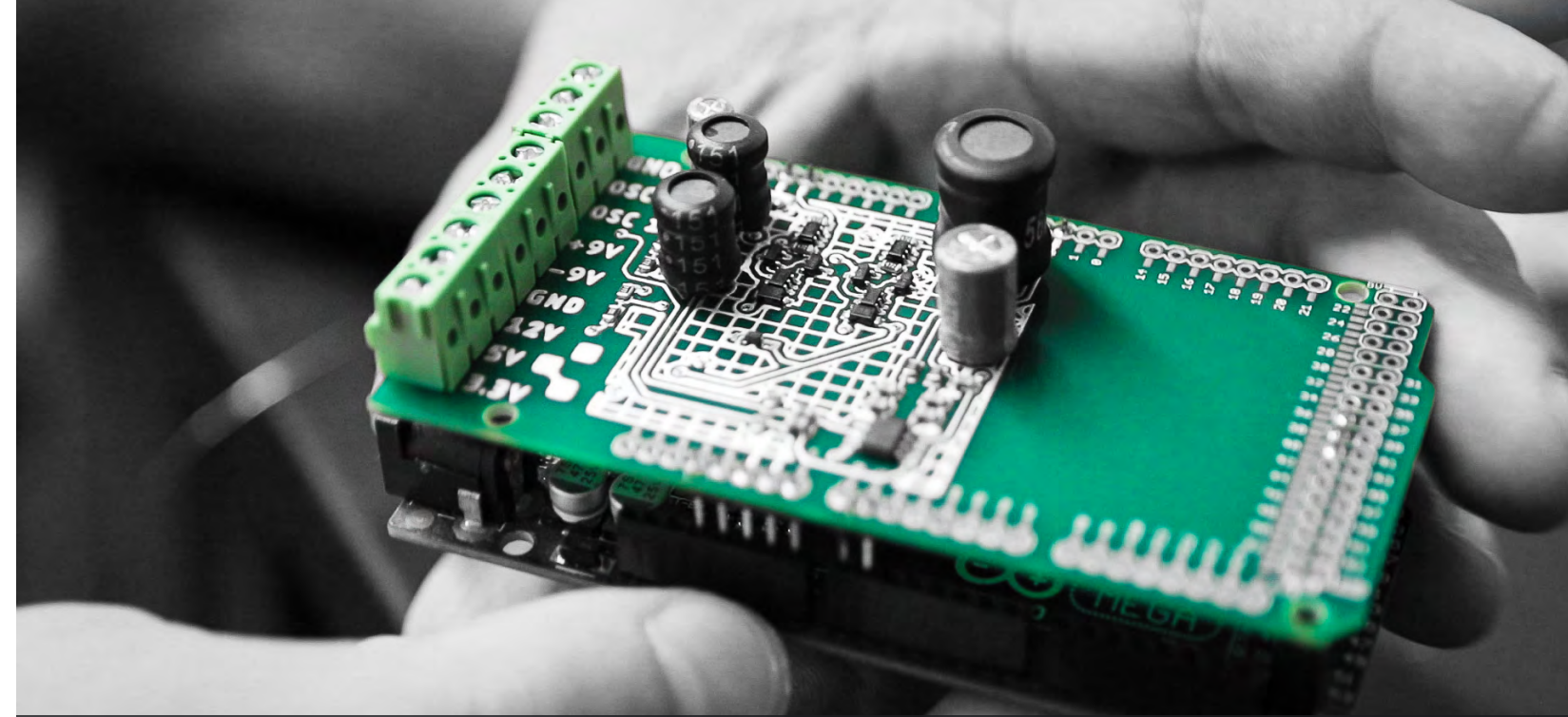

A 'switching power supply' printed on an Arduino Mega template shield. Custom traces, solder paste dispensing and reflow all accomplished on the Voltera V-One.

Template shields for Arduino, Raspberry Pi and more.

Get easily from idea to creation with templates for popular open source microcontrollers.

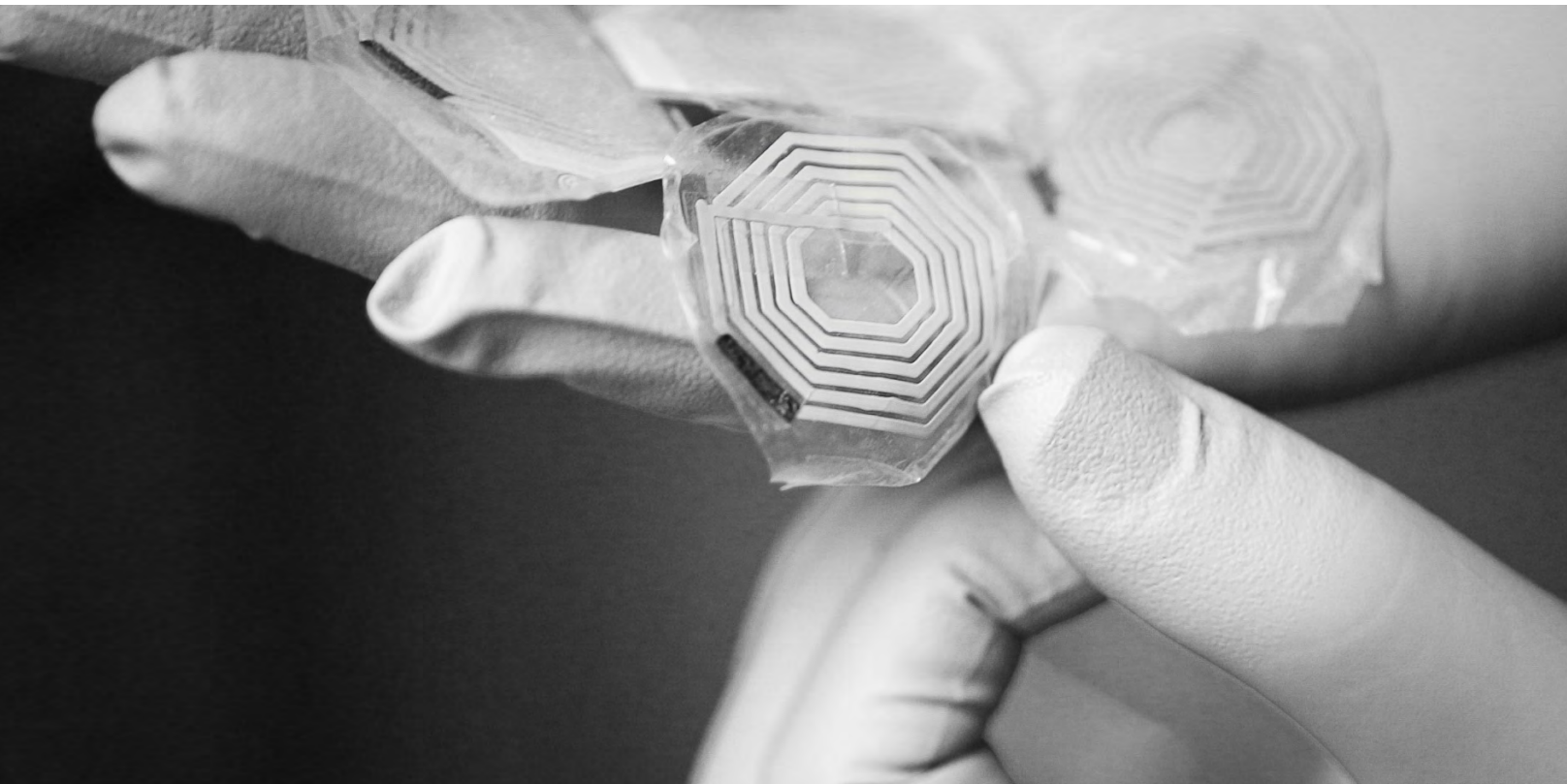

BodyNet, an RFID ID card printed using the Voltera V-One on a sticker that bends and stretches with the skin of your wrist. Created by Postdoctoral scholars Simiao Niu and Naoji Matsuhisa in Zhenen Bao's research group at Stanford University.

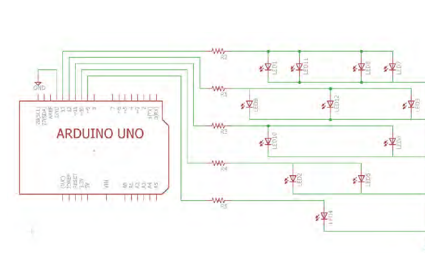

Design

Design your schematic and layout in Eagle, Altium, KiCad, or any other design software with Gerber output. Then, load your design to the V-One software and you're ready to print.

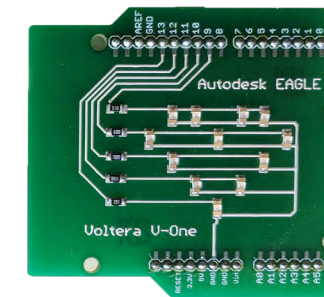

Print & populate

Print and cure your circuit design on template boards specifically designed by Voltera to work with open source microcontrollers. Then dispense solder paste, populate & reflow.

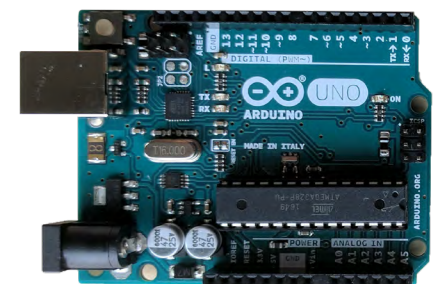

Watch it work

Once the circuit is finished, mount it onto the Arduino and program your prototype. All in all, the above project took less than 2.5 hours from start to finished, functioning device.

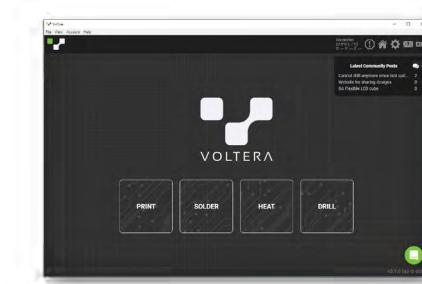

Simple and elegant design.

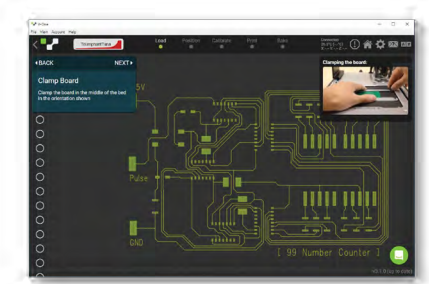

Step-by-step video instructions.



Smart alerts prevent printing issues.



In-app support chat.

Software that teaches every step of the way

Lab software that's as easy and intuitive as a smartphone app.

Sick of using software that was created in the days of dial-up internet and beepers? We are too.

Our software is also completely free: no recurring licenses or big up-front payments required.

Our software is simple and straightforward, with instructional videos to guide you every step of the way. Support chat is built right into the app, and a playlist of detailed support videos will make sure you never get stuck.

You can get started with electronics prototyping moments after your download the software from our website. Download it now for free and upload a few designs to see how easy it is to use.



In-app chat

The V-One was designed to be used by everyone. Even with no experience, you can sit down and print your first circuit in minutes.



Intuitive

Our software is part of what makes the V-One so intuitive. Follow our workflow and you'll go from a blank board to a finished circuit in an hour or two.



Free

Our goal is to help the world build hardware faster, and completely free software is a part of that. No upfront costs or recurring license fees required.

“As an engineer, I know the frustrations of waiting for circuit boards, and the Voltera V-One elegantly solves this problem.”



Sir James Dyson - Inventor & Founder at Dyson



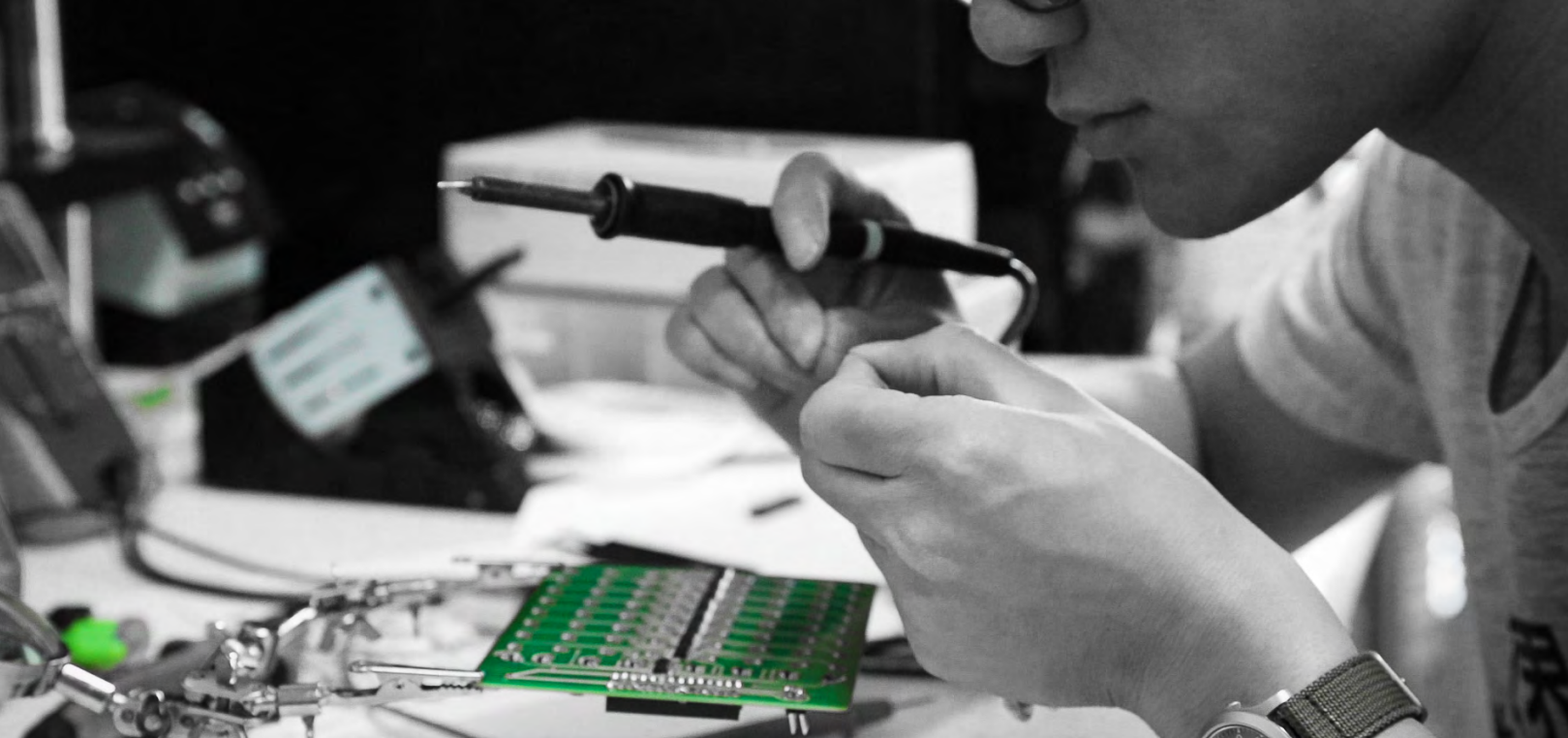

The V-One Spec

PRINTING	METRIC	IMPERIAL
Minimum Trace Width	0.2mm	8mil
Minimum Passive Size	1005	0402
Minimum Pin-to-Pin Pitch	0.65mm	26mil
Resistivity	12mΩ/Sq @ 70um Height	12mΩ/Sq @ 3mil Height
Supplied Substrate Material	FR4	FR4
Maximum Board Thickness	3mm	0.125"

SOLDERING	METRIC	IMPERIAL
Minimum Passive Size	1005	0402
Minimum Pin-to-Pin Pitch	0.5mm	20mil
Solder Paste Alloy	Sn42/Bi57.6/Ag0.4	Sn42/Bi57.6/Ag0.4
Solder Wire Alloy	SnBiAg1	SnBiAg1
Soldering Iron Temperature	180-200°C	355-390°F

FOOTPRINT AND PRINT BED	METRIC	IMPERIAL
Dimensions (L x W x H)	390mm x 257mm x 207mm	15.4" x 10.1" x 8.2"
Weight	7kg	15.4lbs
Print Area	128mm x 116mm	5" x 4.5"
Max. Heated Bed Temperature	240°C	464°F

DRILLING	METRIC	IMPERIAL
Spindle Speed (Max.)	13,000 RPM	13,000 RPM
Power	12V, 25W	12V, 25W
Runout (TIR)	0.076mm	0.003"
Shank Diameter	3.175mm	1/8"
Supplied Substrate Material	FR1	FR1
Bit Diameter (Max.)	2mm	0.078"
Bit Length (Max.)	38.1mm	1.5"

SOLDER COMPATIBILITY	Sn42/Bi57.6/Ag0.4 Solder	Sn63/Pb37 Solder
Standard Ink	✓	X
Flexible Ink	✓	X
Copper PCBs	✓	✓
HASL PCBs	X	✓

SOFTWARE REQUIREMENTS	Operating Systems	Compatible File Format	Connection Type
Operating Systems	Windows 7, 8, 10 (64bit), OSX 10.11+	Gerber	Wired USB 2.0
Compatible File Format		Gerber	
Connection Type			Wired USB 2.0

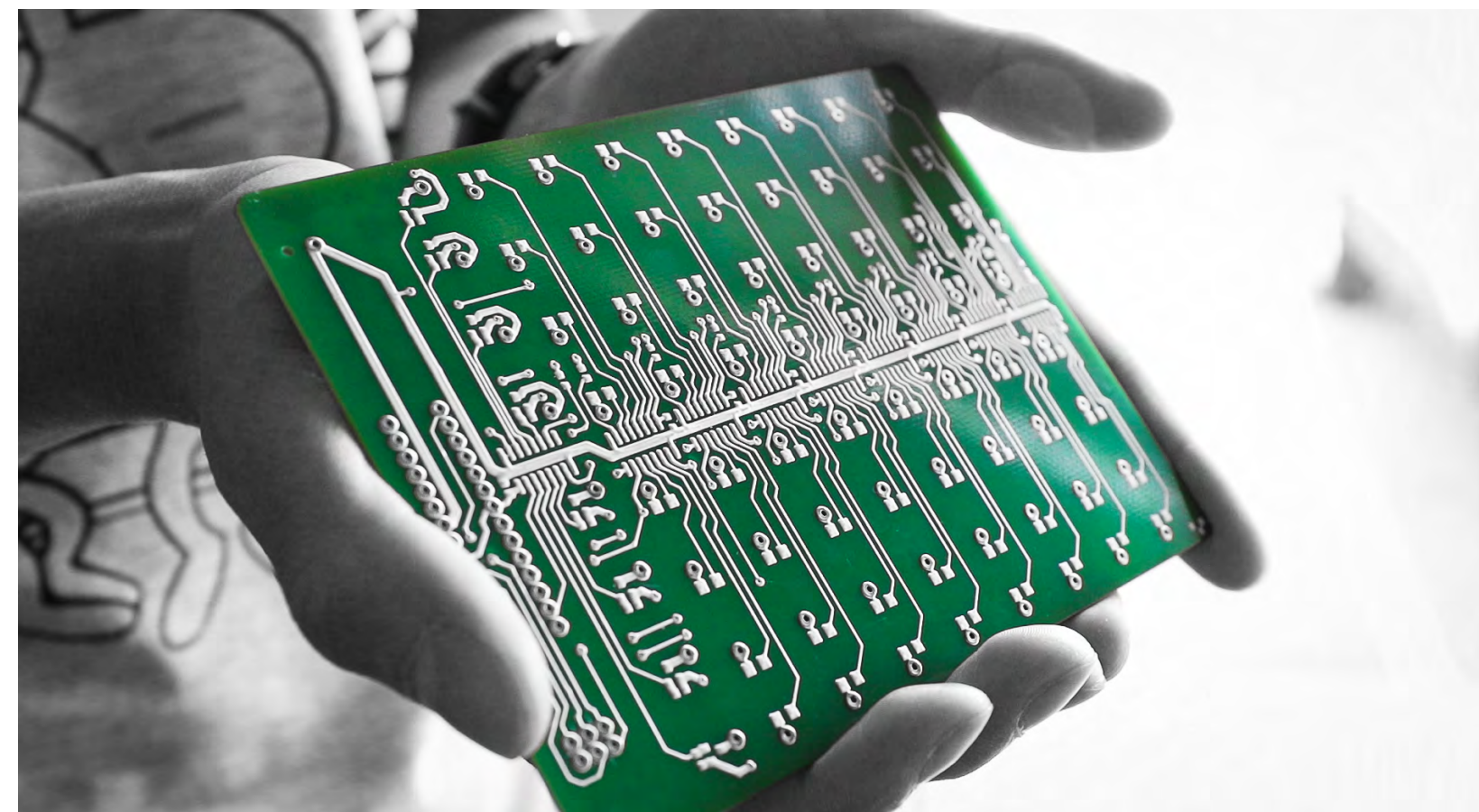

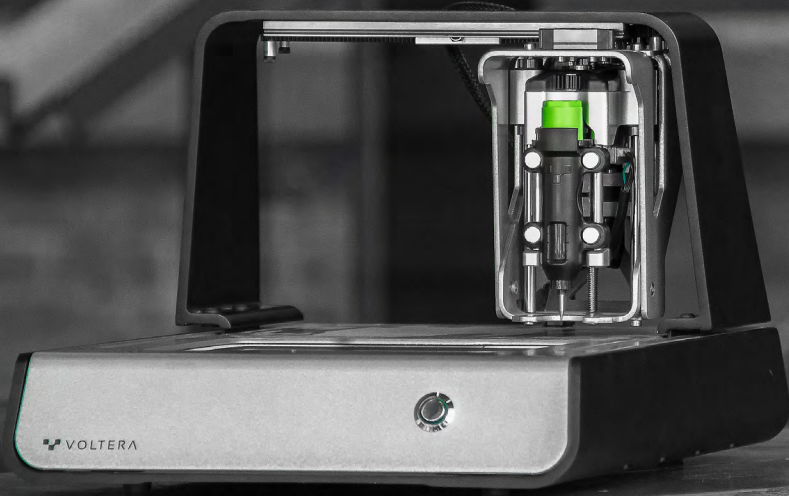

voltera.io

Sales & Technical Inquiries

sales@voltera.io

+1 888-381-3332



BUILD HARDWARE FASTER