

# EVF130

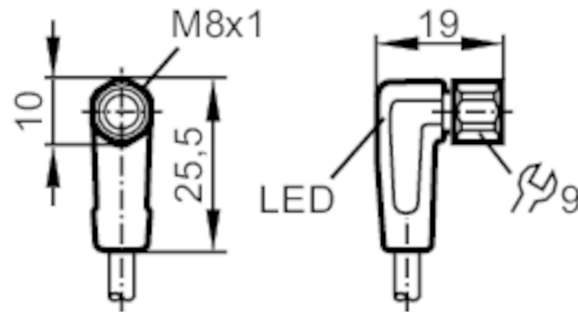

## Connecting cable with socket

ADOAF032VAS0002P03



### Application

Special feature	Free from silicone; Halogen-free; Gold-plated contacts; Drag chain suitability
Application	hygienic and wet areas in the food industry
Free from silicone	yes

### Electrical data

Operating voltage [V]	10...36 DC
Protection class	III
Max. current load total [A]	3

### Outputs

Electrical design	PNP
-------------------	-----

### Operating conditions

Ambient temperature [°C]	-25...80
Ambient temperature (moving) [°C]	5...80
Protection	IP 65; IP 67; IP 68; IP 69K

### Tests / approvals

MTTF [years]	31710
--------------	-------

# EVF130



## Connecting cable with socket

ADOAF032VAS0002P03

Mechanical data		
Weight [g]	68.2	
Dimensions [mm]	19 x 10 x 25.5	
Materials	housing: PP black transparent; Sealing: EPDM	
Material nut	stainless steel (1.4404 / 316L)	
Drag chain suitability	yes	
Drag chain suitability	bending radius for flexible use	min. 10 x cable diameter
	travel speed	max. 3.3 m/s for a horizontal travel length of 5 m and max. acceleration of 5 m/s <sup>2</sup>
	bending cycles	> 1 Mio.
	torsional strain	± 180 °/m

Displays / operating elements		
Display	switching status	1 x LED, yellow
	operation	1 x LED, green

Remarks	
Pack quantity	1 pcs.

Electrical connection	
Cable: 2 m, MPPE, Halogen-free, grey, Ø 4.9 mm; 3 x 0.34 mm <sup>2</sup> (42 x Ø 0.1 mm )	

Electrical connection - socket	
Connector: 1 x M8, angled; Locking: stainless steel (1.4404 / 316L); Contacts: gold-plated; Tightening torque: 0.3...0.5 Nm	



# EVF130



## Connecting cable with socket

ADOAF032VAS0002P03

### Connection

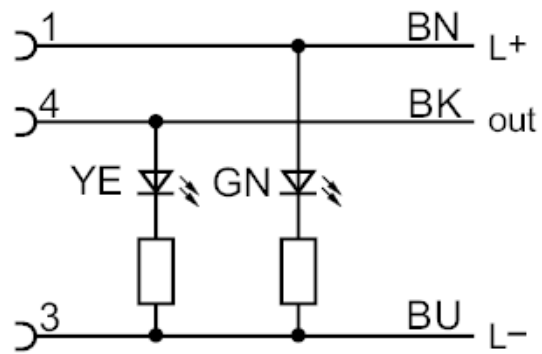

Core colours :

BK = black  
BN = brown  
BU = blue