

Actuator And Sensor Cable / PVC extension cable
RKC5T-1-RSC5T/TEG

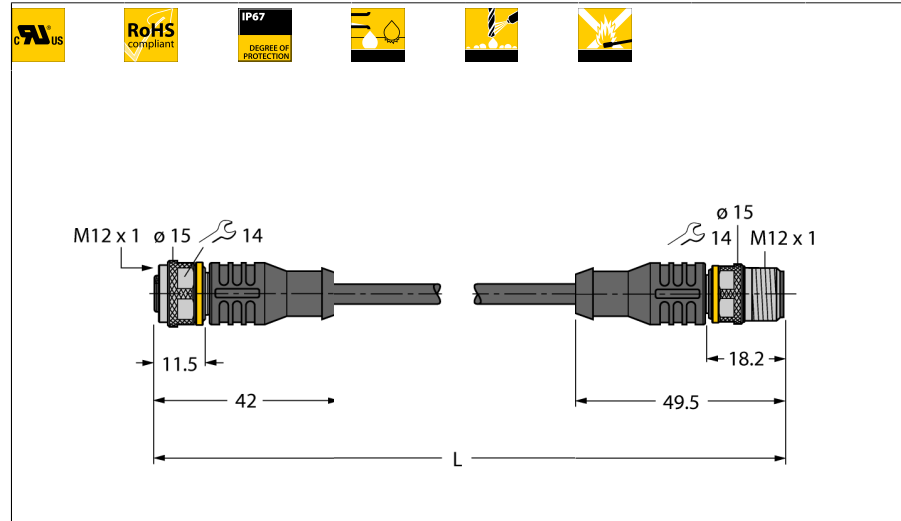

- Female M12, straight, 4-pin + PE
- Male M12, straight, 4-pin + PE
- Sheath material: PVC
- Sheath color: grey
- Resistant to chemicals and oils
- Flame retardant
- Resistant to acids and alkaline solutions
- Resistant to microbes and hydrolysis
- LABS free
- Approval: cULus
- RoHS conform
- Protection class IP67
- Cable length: 1.0 m

Type designation	RKC5T-1-RSC5T/TEG
Ident no.	6629843

Connector A side	Female connector, M12 ♂ 1, Straight
Number of pins	4+PE
Contacts	Brass, CuZn, Gold-plated
Contact carriers	Plastic, TPU, Black
Grip	Plastic, TPU, Black
Coupling nut/screw	Brass, CuZn, Nickel-plated
Seal	Plastic, FPM/FKM
Protection class	IP67, A + B side screwed together
Mechanical lifespan	> 100 Mating cycles
Pollution degree	3
Tightening torque	0.8 ... 1 Nm (observe max. torque of counter piece!)

Connector B side	Connector, M12 x 1, Straight
Number of pins	4+PE pins
Contacts	brass, CuZn, Gold-plated
Contact carriers	Plastic, TPU, Black
Grip	plastic, TPU, black
Coupling nut/screw	Brass, CuZn, Nickel-plated
Protection class	IP67, only in screwed state
Mechanical lifespan	> 100 Mating cycles
Pollution degree	3
Tightening torque	0.8 ... 1 Nm (observe max. torque of counter piece!)

General data	
Cable diameter	5.5 ± 0.20mm
Cable length	1 m
Cable quality	PVC
Cable color	Gray
Core insulation	PVC
Core colors	BN, WH, BU, BK, GNYE
Core cross-section	5x0.34mm ²
Arrangement of strands	42x0.1 mm

Electrical features at +20 °C	
Current	4 A
Rated voltage	60 V
Insulation resistance	> 30.5 MΩ/km
Test voltage	2000 V
Forward resistance	max. 57 Ω/km

Cable Cross-section

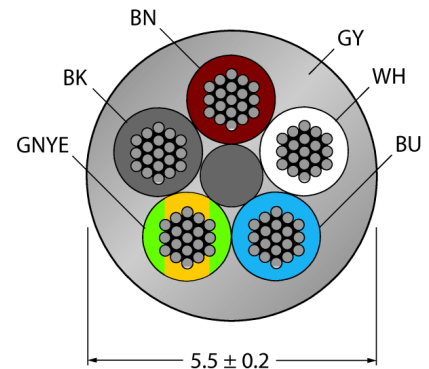

General information

Drawing depicts design version including hexagon coupling nut (Production date after CW11/2016).

Circuit Diagram



**Actuator And Sensor Cable / PVC
extension cable
RKC5T-1-RSC5T/TEG**

Mechanical and chemical properties

Bending radius (stationary laying)	> 5 x Ø
Bending radius (flexible use)	> 10 x Ø
Ambient temperature	
Stationary	-40...+105°C
In motion	0...+80°C

**Actuator And Sensor Cable / PVC
extension cable
RKC5T-1-RSC5T/TEG**

TURCK

Industrial
Automation

Accessories

Type code	Ident no.	Description	
Torque-Wrench-Set-AS	6936170	Torque wrench set; handles with adjustable torque 0.4-1.0 Nm, torque wrench for M8 (SW9), fork wrench for M12 (SW 14)	
BLANK-LABEL-FOR-CORDESETS-TEL-TXL	6936206	Label for TEL and TXL cables, length: 18 mm, height: 4 mm, material: polycarbonate (PC), color: white, halogen-free and flame-retardant	