

Multiple Input Switch Monitor LSI for Automotive

BD3376EFV-C

General Description

BD3376EFV-C is a 10-channel Multiple Input Switch Monitor IC that detects the opening and closing of mechanical switches. Once it senses a change in the status of a switch, it sends an interrupt signal to the MCU via a serial peripheral interface (SPI).

The 10 switch inputs have two types of power supply, VPUB and VPUA. The VPUB and the VPUA power supplies can either be from a battery or from another power supply system. VPUB is the supply for the INB inputs while VPUA is for the INZ and INA inputs.

BD3376EFV-C has two modes of operation, Normal and Sleep. In both modes, the internal registers can be set to make the device perform either intermittent or continuous monitoring of the switches.

In intermittent monitoring, the switch status is monitored at regular time intervals, allowing the IC to operate with low power consumption. Also, operation with reduced noise can be achieved by enabling uniform sequential monitoring of all switches or sequential monitoring by power supply system.

Application

- Engine Control Module

Key Specifications

- Fully Operational Voltage Range: 8V to 26V
- Input Voltage on Switch Pin: -14V to +40V
- Selectable Wetting Current (Min): 1mA, 3mA, 5mA, 10mA, 15mA
- Low -voltage Operating Range: 3.9V to 8.0V

Specifications

- AEC-Q100 Qualified (Note 1)
- Uses 3.3/5.0V SPI Protocol in Communicating with the MCU
- Serial Communication Error Checking through 8bit-CRC
- Thermal Shutdown Protection (TSD)
- Power on Reset (POR)
- Selectable Source/Sink Current Levels through Register Settings
- Wetting Current Timer Capability
- 4 Source or Sink Input Terminals
- 6 Source Input Terminals
- Separable Power Supply
VPUA: 7ch (INA&INZ), VPUB: 3ch (INB)
- Interrupt Notification upon Switch Status Change
- 1 to 10 Times Matched LPF that Eliminates Input Terminal Noise
- Low Current Consumption (Intermittent Monitoring)
- Status Display of Selected Terminal at DMUX Terminal (Note 1) Grade 1

Package

HTSSOP-B30

W(Typ) x D(Typ) x H(Max)

10.00mm x 7.60mm x 1.00mm

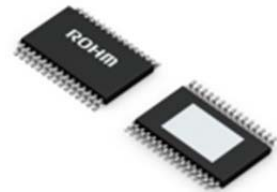

Typical Application Circuit

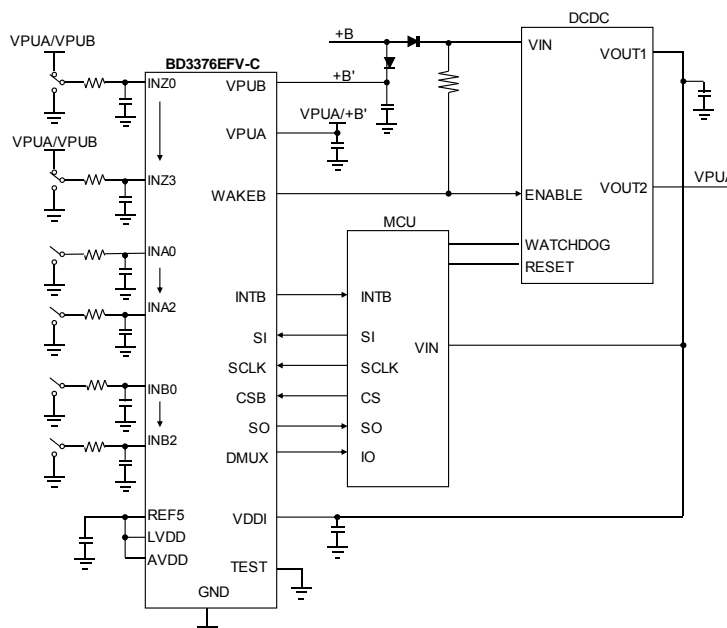

Figure 1. Typical Application Circuit

Pin Configuration

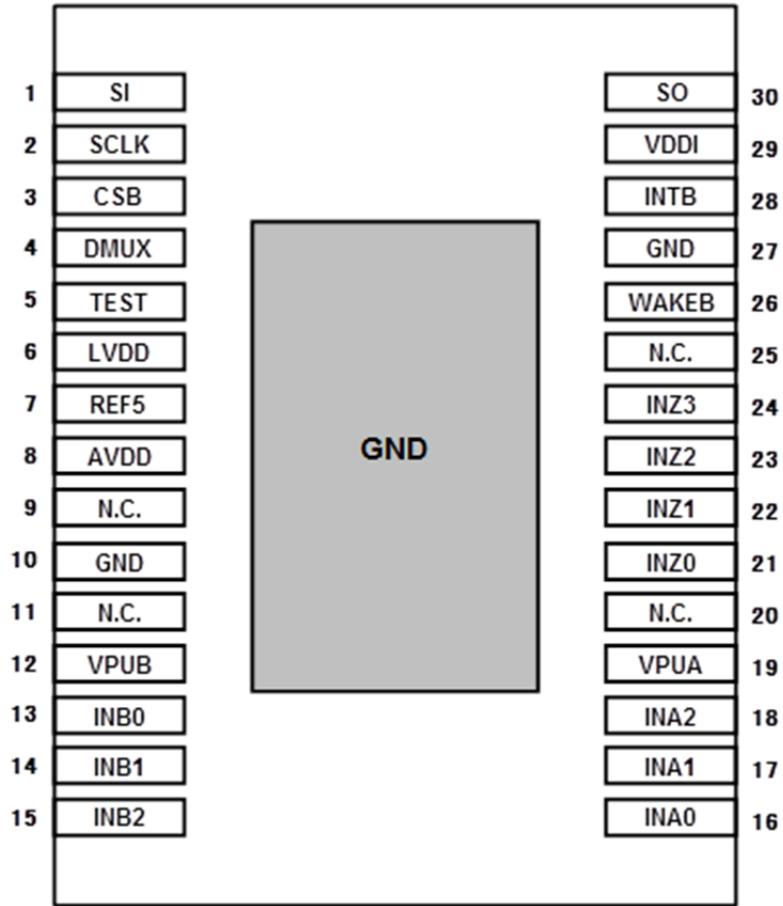

Figure 2. Pin Configuration (Top View)

Pin Description

Table 1. Pin Description

Pin No.	Pin Name	Function	Description	Equivalent Circuit Diagram (Note 2)
1	SI	Input	SPI control data input pin from the MCU (with an internal pull-down resistor)	A
2	SCLK	Input	SPI control clock input pin from the MCU (with an internal pull-down resistor)	A
3	CSB	Input	SPI control chip select input pin from the MCU (with an internal pull-up current source)	B
4	DMUX	Output	Digital multiplexer for switch input output pin	G
5	TEST	Input	Test mode control pin (Note 3) (with an internal pull-down resistor)	J
6	LVDD	Input	Power supply input pin for the logic block (Note 4)	--
7	REF5	Output	5V power supply output pin (Note 4)	I
8	AVDD	Input	Power supply input pin for the analog block (Note 4)	--
9	N.C.	-	No Connection	--
10	GND	Ground	Ground	--
11	N.C.	-	No Connection	--
12	VPUB	Input	Power supply input pin for the main system and INB switches	--
13	INB0	Input	Switch input pin 0 under VPUB power supply system (with an internal pull-up current source)	F
14	INB1	Input	Switch input pin 1 under VPUB power supply system (with an internal pull-up current source)	F
15	INB2	Input	Switch input pin 2 under VPUB power supply system (with an internal pull-up current source)	F
16	INA0	Input	Switch input pin 0 under VPUA power supply system (with an internal pull-up current source)	F
17	INA1	Input	Switch input pin 1 under VPUA power supply system (with an internal pull-up current source)	F
18	INA2	Input	Switch input pin 2 under VPUA power supply system (with an internal pull-up current source)	F
19	VPUA	Input	Power supply input pin for INA and INZ switches	--
20	N.C.	-	No Connection	--
21	INZ0	Input	Switch input pin 0 under VPUA power supply system (with an internal pull-up/down current source)	E
22	INZ1	Input	Switch input pin 1 under VPUA power supply system (with an internal pull-up/down current source)	E
23	INZ2	Input	Switch input pin 2 under VPUA power supply system (with an internal pull-up/down current source)	E
24	INZ3	Input	Switch input pin 3 under VPUA power supply system (with an internal pull-up/down current source)	E
25	N.C.	-	No Connection	--
26	WAKEB	Output	Open-drain output pin to monitor the mode of operation (Note 5)	D
27	GND	Ground	Ground pin	--
28	INTB	Output	Open-drain interrupt output pin to the MCU (with an internal pull-up resistor)	C
29	VDDI	Input	Power supply pin for CSB, SI, SCLK, SO, INTB and DMUX	--
30	SO	Output	SPI data output pin to the MCU	H

(Note 2) Ref. Page 65 I/O Equivalence Circuit

(Note 3) Short TEST pin to ground when mounted.

(Note 4) Short REF5 pin to AVDD pin and LVDD pin, and connect a 4.7μF(Min) capacitor between it and ground.

Do not use it as voltage source to another IC.

(Note 5) In the application circuit, WAKEB should be pulled-up by an external resistor.

Block Diagram

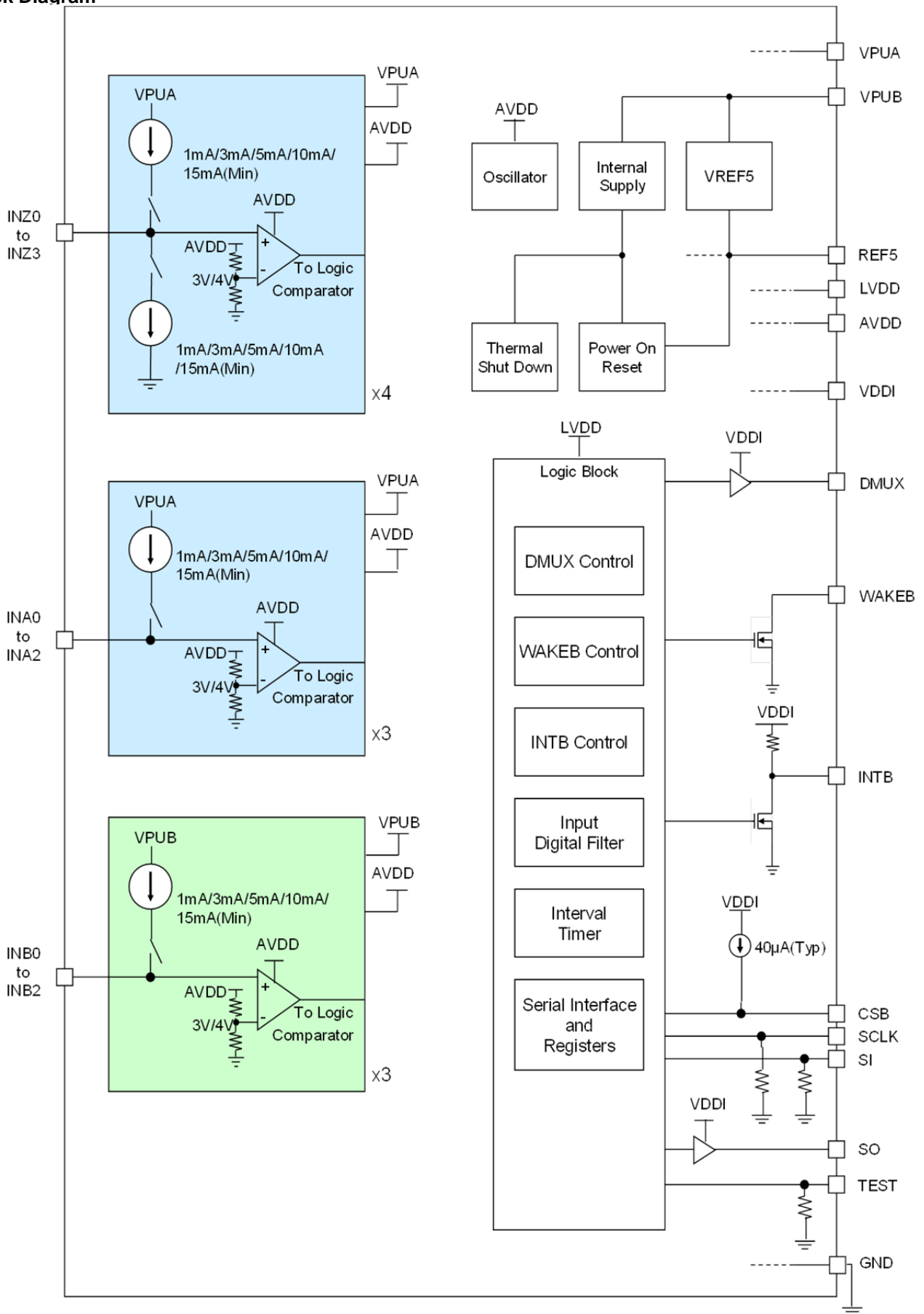

Figure 3. Block Diagram

Absolute Maximum Ratings

Table 2. Absolute Maximum Ratings

Parameter	Symbol	Ratings	Unit
Supply Voltage Range on Pin VDDI, AVDD, LVDD Input Voltage Range on Pin CSB, SI, SCLK, TEST Output Voltage Range at Pin SO, INTB, DMUX, REF5	-	-0.3 to +7.0	V
Supply Voltage Range on Pin VPUA, VPUB Voltage Range on Pin WAKEB	-	-0.3 to +40	V
Input Current at Pin WAKEB	-	10	mA
Input Voltage on Switch Pin (INB0 to INB2, INA0 to INA2, INZ0 to INZ3)	-	-14 to +40	V
Storage Temperature Range	Tstg	-55 to +150	°C
Maximum Junction Temperature	Tj	-40 to +150	°C

Caution: Operating the IC over the absolute maximum ratings may damage the IC. The damage can either be a short circuit between pins or an open circuit between pins and the internal circuitry. Therefore, it is important to consider circuit protection measures, such as adding a fuse, in case the IC is operated over the absolute maximum ratings.

Thermal Resistance (Note 6)

Table 3. Thermal Resistance

Parameter	Symbol	Thermal Resistance (Typ)		Unit
		1s (Note 8)	2s2p (Note 9)	
HTSSOP-B30				
Junction to Ambient	θ_{JA}	111.9	22.5	°C/W
Junction to Top Characterization Parameter (Note 7)	Ψ_{JT}	2	1	°C/W

(Note 6) Based on JESD51-2A (Still-Air)

(Note 7) The thermal characterization parameter to report the difference between junction temperature and the temperature at the top center of the outside surface of the component package.

(Note 8) Using a PCB board based on JESD51-3 (Table 4).

(Note 9) Using a PCB board based on JESD51-5, 7 (Table 5).

Table 4. 1s

Layer Number of Measurement Board	Material	Board Size
Single	FR-4	114.3mm x 76.2mm x 1.57mm
Top		
Copper Pattern	Thickness	
Footprints and Traces	70 μ m	

Table 5. 2s2p

Layer Number of Measurement Board	Material	Board Size	Thermal Via (Note 10)		
			Pitch	Diameter	
4 Layers	FR-4	114.3mm x 76.2mm x 1.6mm	1.20mm	Φ 0.30mm	
Top		2 Internal Layers		Bottom	
Copper Pattern	Thickness	Copper Pattern	Thickness	Copper Pattern	Thickness
Footprints and Traces	70 μ m	74.2mm x 74.2mm	35 μ m	74.2mm x 74.2mm	70 μ m

(Note 10) This thermal via connects with the copper pattern of all layers.

Recommended Operating Conditions

Table 6. Recommended Operating Conditions

Parameter	Symbol	Ratings		Unit
		Min	Max	
Operating Temperature	Topr	-40	+125	°C
VPUA/VPUB Supply Voltage	V _{VPUX}	8.0	26	V
VDDI Supply Voltage	V _{VDDI}	3.1	5.25	V
Capacitance for REF5 (Note 11)	C _{REF}	4.7	-	μ F

(Note 11) Recommend a ceramic capacitance. Please consider variation of capacitance.

Electrical Characteristics

Spec conditions: $8.0V \leq V_{PUA}/V_{PUB} \leq 26V$, $3.1V \leq V_{DDI} \leq 5.25V$, $-40^{\circ}C \leq T_{opr} \leq +125^{\circ}C$

$V_{PUA}/V_{PUB}/INZ/INA/INB$ terminal: resistors and capacitors are not connected

REF5 terminal: $4.7\mu F$

Unless otherwise specified, the typical condition is $V_{PUA}/V_{PUB}=13V$, $V_{DDI}=5.00V$, $T_{opr}=25^{\circ}C$.

Table 7. Electrical Characteristics

Parameter	Symbol	Min	Typ	Max	Unit
VPUA/VPUB Supply Voltage					
Low -voltage Operating Range ^(Note 12)	$V_{VPUX(QFL)}$	3.9	-	8.0	V
Fully Operational Voltage Range	$V_{VPUX(FO)}$	8.0	-	26.0	
High-voltage Operating Range ^(Note 13)	$V_{VPUX(QFH)}$	26	-	40	
POR(Power on Reset) Activation Voltage ^(Note 14)	$V_{POR(LOW)}$	3.9	4.2	4.5	V
POR(Power on Reset) Deactivation Voltage ^(Note 14)	$V_{POR(HIGH)}$	4.0	4.3	4.6	V
VPUA/VPUB Operating Current					
Continuous Monitoring	$I_{VPUX(OFF)}$	-	-	480	μA
Current source is invalid, "Hi-Z" Status					
VPUA/VPUB Average Operating Current					
Intermittent Monitoring	$I_{VPUX(SS)}$	-	75	100	μA
Source/Sink Current Setting=1mA					
Monitoring Period=50ms, Strobe Time=125 μs					
VDDI Operating Current					
INTB="H", CSB="H"	I_{VDDI}	-	5	10	μA
REF5 Output Voltage	V_{REF5}	4.75	5.00	5.25	V

(Note 12) Electrical characteristics are not guaranteed though functions are operating. POR is active between 3.9V and 4.5V.

(Note 13) Electrical characteristics are not guaranteed though functions are operating.

(Note 14) The POR circuit monitors the REF5 voltage.

Electrical Characteristics - continued

Table 8. Electrical Characteristics (Switch Input)

Parameter	Symbol	Min	Typ	Max	Unit
Source Current 1 (Internal Pull-up Current Source) 0V External Supply, VPUA/VPUB System (1mA Setting)	I _{SOURCE1}	1.0	1.4	1.8	mA
Sink Current 1 (Internal Pull-down Current Source) 8V External Supply, VPUA System (1mA Setting)	I _{SINK1}	1.0	1.4	1.8	mA
Source Current 2 (Internal Pull-up Current Source) 0V External Supply, VPUA/VPUB System (3mA Setting)	I _{SOURCE3}	3.0	4.2	5.4	mA
Sink Current 2 (Internal Pull-down Current Source) 8V External Supply, VPUA System (3mA Setting)	I _{SINK3}	3.0	4.2	5.4	mA
Source Current 3 (Internal Pull-up Current Source) 0V External Supply, VPUA/VPUB System (5mA Setting)	I _{SOURCE5}	5.0	7.0	9.0	mA
Sink Current 3 (Internal Pull-down Current Source) 8V External Supply, VPUA System (5mA Setting)	I _{SINK5}	5.0	7.0	9.0	mA
Source Current 4 (Internal Pull-up Current Source) 0V External Supply, VPUA/VPUB System (10mA Setting)	I _{SOURCE10}	10.0	14.0	18.0	mA
Sink Current 4 (Internal Pull-down Current Source) 8V External Supply, VPUA System (10mA Setting)	I _{SINK10}	10.0	14.0	18.0	mA
Source Current 5 (Internal Pull-up Current Source) 0V External supply, VPUA/VPUB System (15mA Setting)	I _{SOURCE15}	15.0	21.0	27.0	mA
Sink Current 5 (Internal Pull-down Current Source) 8V External Supply, VPUA System (15mA Setting)	I _{SINK15}	15.0	21.0	27.0	mA
Low to High Switch Detection Threshold Voltage (3.0V Setting)	V _{TH3(HIGH)}	2.7	3.0	3.3	V
High to Low Switch Detection Threshold Voltage (3.0V Setting)	V _{TH3(LOW)}	2.6	2.9	3.2	V
Low to High Switch Detection Threshold Voltage (4.0V Setting)	V _{TH4(HIGH)}	3.7	4.0	4.3	V
High to Low Switch Detection Threshold Voltage (4.0V Setting)	V _{TH4(LOW)}	3.6	3.9	4.2	V

Electrical Characteristics - continued

Table 9. Electrical Characteristics (Static Electrical Characteristics)

Parameter	Symbol	Min	Typ	Max	Unit
Serial Interface Threshold Voltage ^(Note 15)	$V_{INLOGIC}$	0.8	-	2.2	V
CSB Input Current CSB=VDDI	$I_{CSB(HIGH)}$	-10	-	+10	μA
CSB Pull-up Current CSB=0V	$I_{CSB(LOW)}$	30	40	85	μA
SI, SCLK Pull-down Resistor	R_{SI}, R_{SCLK}	50	100	150	k Ω
SI, SCLK Input Current SI, SCLK=0V	$I_{SI(LOW)}, I_{SCLK(LOW)}$	-10	-	+10	μA
SO "H" Level Output Voltage $I_{SOURCE}=200\mu A$	$V_{SO(HIGH)}$	$V_{VDDI}-0.8$	-	V_{VDDI}	V
SO "L" Level Output Voltage $I_{SINK}=1.6mA$	$V_{SO(LOW)}$	-	-	0.4	V
SO (Set to "Hi-Z") Input Current 0V to VDDI	$I_{SO(TRI)}$	-10	-	+10	μA
DMUX "H" Level Output Voltage $I_{SOURCE}=200\mu A$	$V_{DMUX(HIGH)}$	$V_{VDDI}-0.8$	-	V_{VDDI}	V
DMUX "L" Level Output Voltage $I_{SINK}=1.6mA$	$V_{DMUX(LOW)}$	-	-	0.4	V
INTB Internal Pull-up Current	$I_{INTB(PU)}$	15	53	85	μA
INTB "H" Level Output Voltage INTB=OPEN	$V_{INTB(HIGH)}$	$V_{VDDI}-0.5$	-	V_{VDDI}	V
INTB "L" Level Output Voltage $I_{SINK}=1.0mA$	$V_{INTB(LOW)}$	-	0.2	0.4	V
WAKEB "L" Level Output Voltage WAKEB=1.0mA	$V_{WAKEB(LOW)}$	-	0.2	0.4	V
WAKEB (Set to "Hi-Z") Input Current 0V to VPUB	$I_{WAKEB(TRI)}$	-10	-	+10	μA

(Note 15) Applicable to SCLK, SI, CSB

Electrical Characteristics - continued

Table 10. Electrical Characteristics (Dynamic Electrical Characteristics)

Parameter	Symbol	Min	Typ	Max	Unit
Wetting Current Timer Counting starts after n-times detection of matched LPF	t_{WCT}	13	-	22	ms
Interrupt Delay Time 1 Time from switch status change to INTB output change in continuous monitoring	t_{INTB_DLY1}	-	-	1	ms
Interrupt Delay Time 2 Time from switch status change to INTB output change in intermittent monitoring n: Setting time of LPF matched n-times	t_{INTB_DLY2}	-	-	[Monitor cycle] x n+1	ms
Interrupt Clear Time Time from CSB rising edge to INTB output change	t_{INTB_CLR}	-	-	150	μ s
Command Set Time Time from CSB rising edge to setting of register	t_{REG_EN}	-	-	150	μ s
Transition Time to Normal Mode Time from CSB rising edge to WAKEB output change	t_{WAKEB_DLY1}	-	-	1	ms
Transition Time to Sleep Mode Time from CSB rising edge to WAKEB output change	t_{WAKEB_DLY2}	-	-	1	ms
Switch Strobe Time (93.75 μ s Setting) ^(Note 16)	t_{SCAN_94}	84.375	93.750	103.125	μ s
Switch Strobe Time (125 μ s Setting) ^(Note 16)	t_{SCAN_125}	112.5	125.0	137.5	μ s
Switch Strobe Time (187.5 μ s Setting) ^(Note 16)	t_{SCAN_188}	168.75	187.50	206.25	μ s
Switch Strobe Time (250 μ s Setting) ^(Note 16)	t_{SCAN_250}	225	250	275	μ s
Source/Sink Current Rise Time FSQ="0", FSQZ/A/B="0", 10mA Setting Load Resistance 100 Ω	t_{SR_R}	-	20 ^(Note 17)	-	μ s
Source/Sink Current Fall Time FSQ="0", FSQZ/A/B="0", 10mA Setting Load Resistance 100 Ω	t_{SR_F}	-	15 ^(Note 17)	-	μ s
Internal Clock Accuracy	t_{TIMER}	-10	-	+10	%

(Note 16) "H" width of internal signal (Ref. Page 12 Figure 6).

(Note 17) Reference value.

Electrical Characteristics - continued

Table 11. Electrical Characteristics (Digital Interface Characteristics)

Parameter	Symbol	Min	Typ	Max	Unit
SCLK Frequency	f_{SCLK}	-	-	4.4	MHz
Setup Time from CSB Fall to SCLK Rise	t_{LEAD}	100	-	1000	ns
Setup Time from SCLK Fall to CSB Rise	t_{LAG}	50	-	500	ns
Setup Time from SI to SCLK Fall	$t_{SI(SU)}$	16	-	-	ns
Hold Time from SCLK Fall to SI	$t_{SI(HOLD)}$	20	-	-	ns
SI, CSB, SCLK Rise Time	$t_{R(SI)}$	-	5.0 ^(Note 18)	-	ns
SI, CSB, SCLK Fall Time	$t_{F(SI)}$	-	5.0 ^(Note 18)	-	ns
Time from CSB Rising to SO Output Low Impedance	$t_{SO(EN)}$	-	-	55	ns
Time from CSB Rising to SO Output High Impedance	$t_{SO(DIS)}$	-	-	55	ns
SCLK "H" Level Width	t_{SCLKH}	75	-	-	ns
SCLK "L" Level Width	t_{SCLKL}	75	-	-	ns
Time from SCLK Rise to Stable SO Data Output SO $C_L=20pF$	t_{VALID}	-	25	55	ns
CSB "H" Level Time	t_{CSBH}	150	-	-	μs

(Note 18) Reference value.

Timing Chart

Serial Access Timing

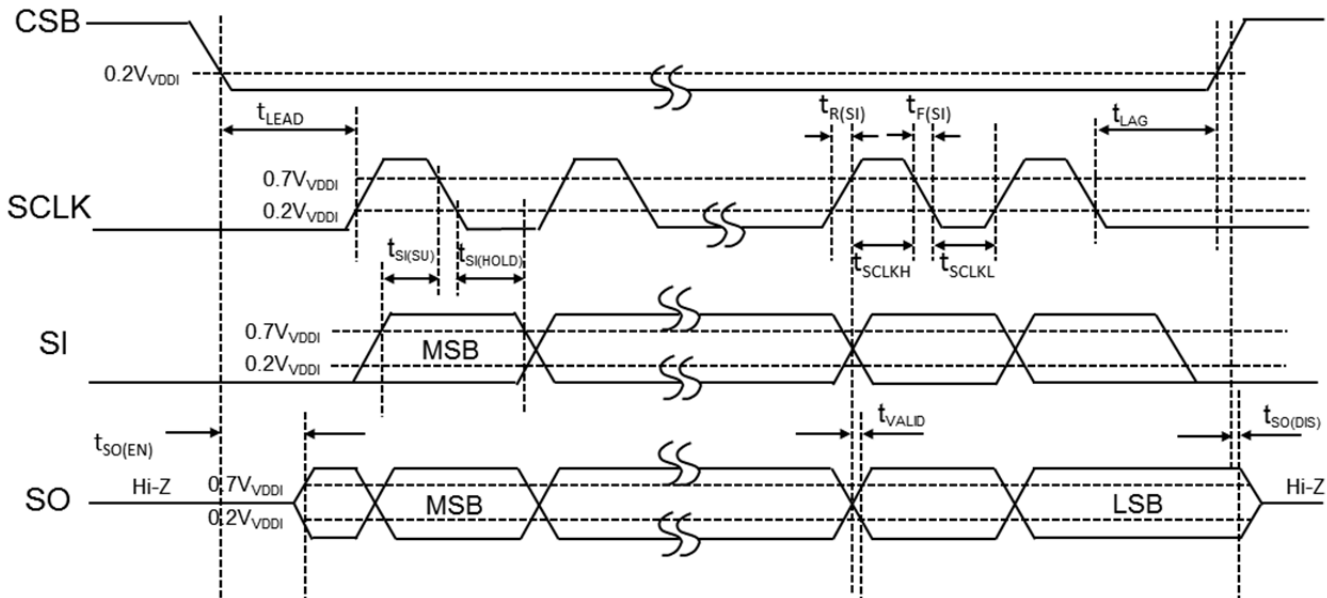

Figure 4. Serial Access Timing

Timing Chart - continued

·Power Supply Rising/Falling Sequence

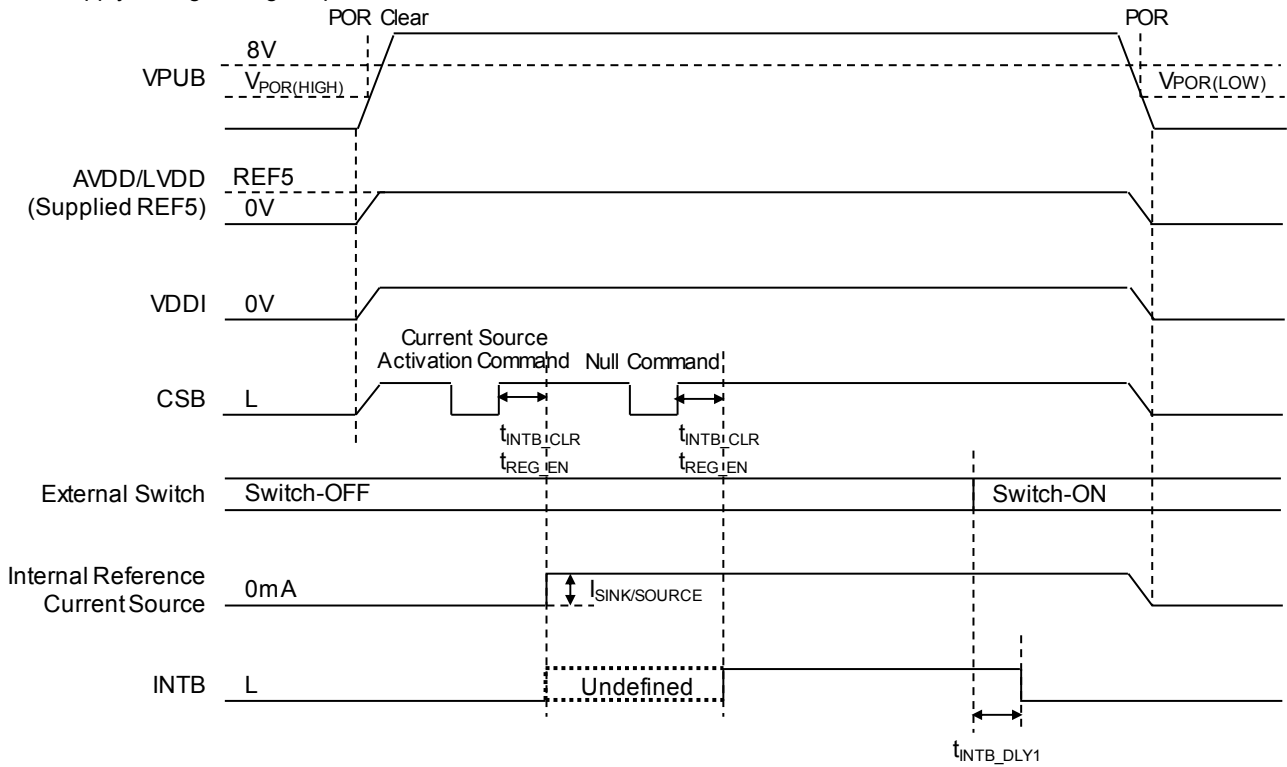

Figure 5. Power Supply Rising/Falling Sequence

·Source/Sink Current Rise and Fall Time

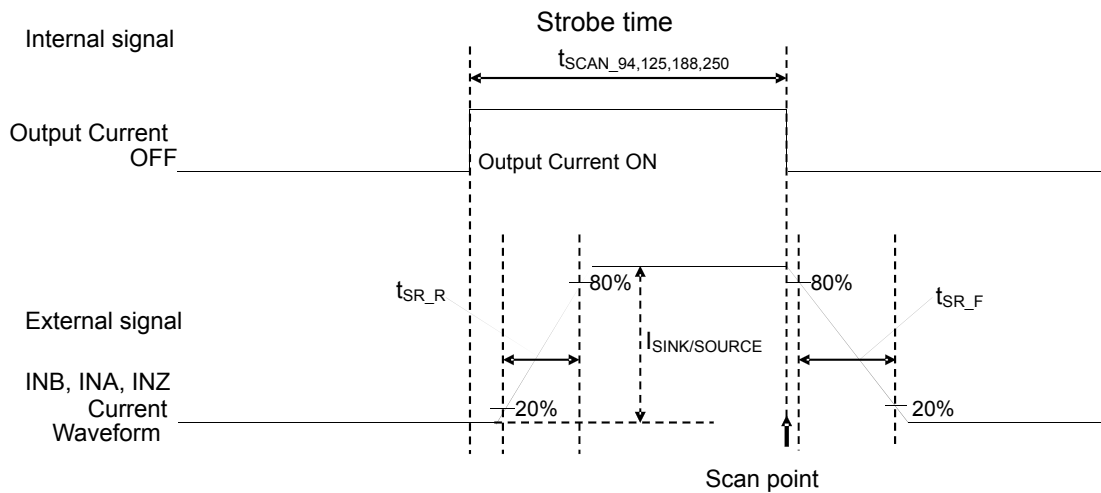

Figure 6. Intermittent Monitoring Enabled (FSQ=0, FSQZ/A/B=0, CMB/A/Z=1), Source/Sink Current Rise and Fall Time

Basic Operations

[Basic Operation 1] Detection of Switch Status Change (Continuous Monitoring)

Upon detection of a change in switch status, interrupt (INTB="H"→"L") occurs and the IC requests serial communication with the MCU.

< Example of Recommended Operation Sequence >

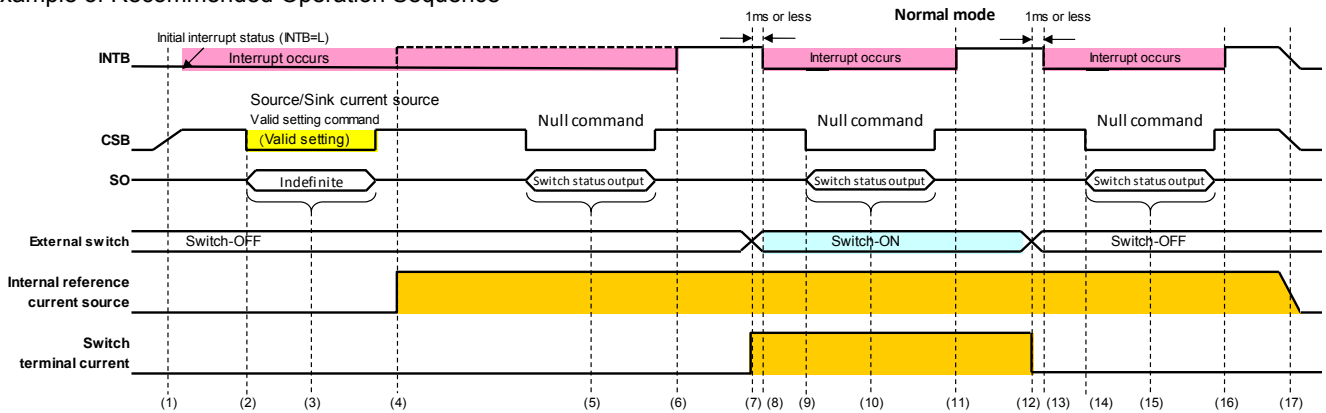

Figure 7. Basic Operation 1

- (1) After power is turned on, interrupt (INTB="L") occurs.
- (2) By serial communication, the switch status is obtained by the MCU at CSB falling edge.
- (3) Since the current source is OFF, the switch terminal is "Hi-Z", and the output of SO is undefined.
- (4) Internal reference current source is activated.
- (5) Switch status is output by SO.
- (6) Interrupt is cleared (INTB="L"→"H") by CSB rising edge and prepares for switch change.
- (7) Switch change occurs (OFF→ON) and IC detects switch status change.
- (8) Interrupt (INTB="H"→"L") is notified to MCU, and serial communication is requested.
- (9) By serial communication, the switch status is obtained by the MCU at CSB falling edge.
- (10) Switch status is output by SO.
- (11) Interrupt is cleared (INTB="L"→"H") by CSB rising edge and prepares for switch change.
- (12) Switch change occurs (ON→OFF) and IC detects switch status change.
- (13) Interrupt (INTB="H"→"L") is notified to MCU, and serial communication is requested.
- (14) By serial communication, the switch status is obtained by the MCU at CSB falling edge.
- (15) Switch status is output by SO.
- (16) Interrupt is cleared (INTB="L"→"H") by CSB rising edge and prepares for switch change.
- (17) Power is turned off.

Basic Operations - continued

[Basic Operation 2] Detection of Switch Status Change (Intermittent Monitoring)

When Intermittent Monitoring is enabled, switch status is monitored by periodically turning the current source on and off. Intermittent monitoring allows low power consumption.

< Example of Recommended Operation Sequence >

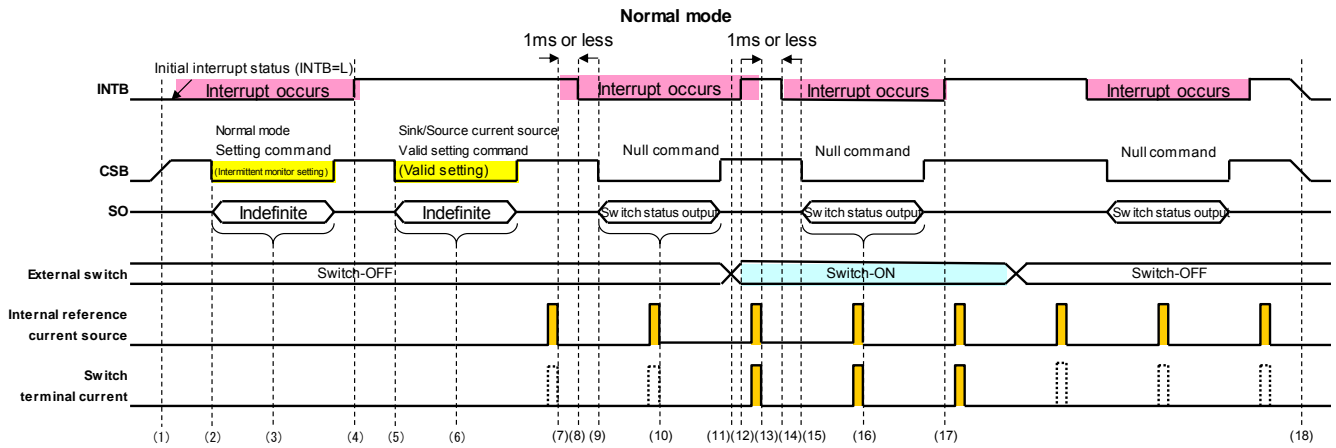

Figure 8. Basic Operation 2

- (1) After power is turned on, interrupt (INTB="L") occurs.
- (2) By serial communication, the switch status is obtained by the MCU at CSB falling edge.
- (3) Since the current source is OFF, the switch terminal is "Hi-Z", and the output of SO is undefined.
- (4) Interrupt is cleared (INTB="L" → "H") by CSB rising edge and prepares for switch change.
- (5) By serial communication, the switch status is obtained by the MCU at CSB falling edge.
- (6) Since the current source is OFF, the switch terminal is "Hi-Z", and the output of SO is undefined.
- (7) IC gets the switch status when the current source is ON.
- (8) Interrupt (INTB="H" → "L") is notified to MCU, and serial communication is requested.
- (9) By serial communication, switch status is obtained by the MCU at CSB falling edge.
- (10) Switch status is output by SO.
- (11) IC detects switch status change.
- (12) Interrupt is cleared (INTB="L" → "H") by CSB rising edge and prepares for switch change.
- (13) IC detects switch status change.
- (14) Interrupt (INTB="H" → "L") is notified to MCU, and serial communication is requested.
- (15) By serial communication, switch status is obtained by the MCU at CSB falling edge.
- (16) Switch status is output by SO.
- (17) Interrupt is cleared (INTB="L" → "H") by CSB rising edge and prepares for switch change.
- (18) Power is turned off.

Basic Operations - continued

[Basic Operation 3] Sleep Mode Operation (Manual Transition)

When MDC register of Monitor Mode Transition Command is set to "1", mode is changed to sleep.
 When MDC register of Monitor Mode Transition Command is set to "0", mode is changed to normal.
 During sleep mode, WAKEB is in "Hi-Z" state and its voltage level is the level of the external pull-up.

< Example of Recommended Operation Sequence >

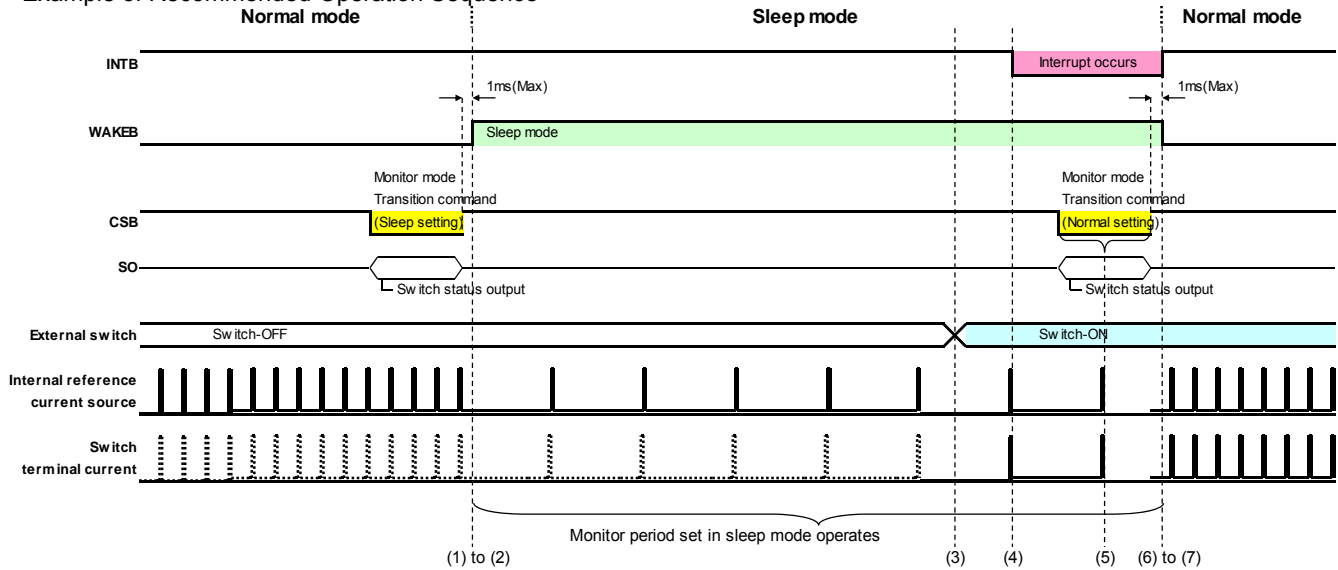

Figure 9. Basic Operation 3

- (1) Monitor mode transition command (Sleep mode setting) is received from MCU.
- (2) Transition to sleep mode.
- (3) Switch change occurs (OFF→ON).
- (4) IC detects switch status change.
- (5) IC informs MCU the interrupt (INTB="H"→"L") and switch status is output by SO.
- (6) Monitor mode transition command (Normal mode setting) is received from MCU.
- (7) Transition to normal mode.

Basic Operations - continued

[Basic Operation 4] Sleep Mode Operation (Automatic Transition to Normal Mode)

Automatic transition from sleep mode to normal mode when a switch status changes is possible when the automatic mode transition setting is enabled.
 During sleep mode, WAKEB is in “Hi-Z” state and its voltage level is the level of the external pull-up.

< Example of Recommended Operation Sequence >

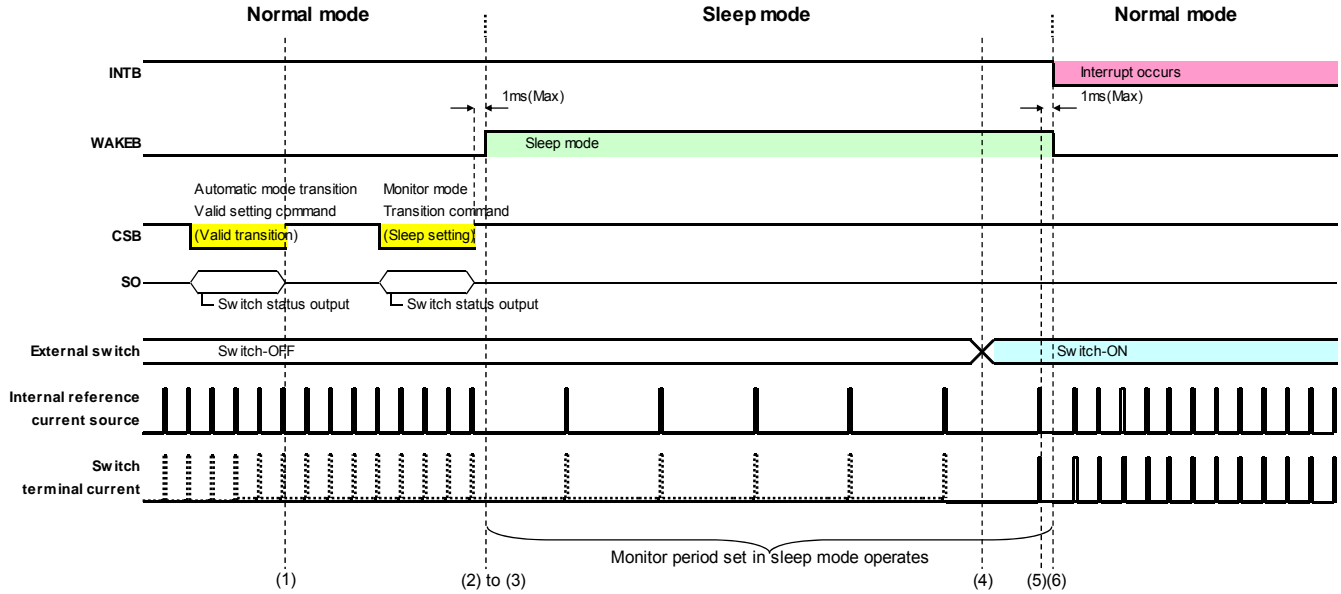

Figure 10. Basic Operation 4

- (1) Automatic transition of mode is enable.
- (2) Monitor mode transition command (sleep mode setting) is received from MCU.
- (3) Transition to sleep mode.
- (4) Switch change occurs (OFF→ON).
- (5) IC detects switch status change.
- (6) IC informs the interruption to MCU with INTB(“H” →“L”) and changes to Normal mode automatically.

Description of Functions

1. Power on Reset (POR)

Upon the application of an external voltage to V_{PUB}, REF5 output is generated by the LDO inside the IC.
 When REF5 ≤ 4.2(Typ), POR is activated.
 When REF5 ≥ 4.3(Typ), POR is deactivated.

2. Serial Interface

Communication between BD3376EFV-C and the MCU uses terminals chip select bar input (CSB), serial clock input (SCLK), serial data input (SI), and serial data output (SO).
 CSB is internally pulled-up to VDDI. When CSB status is “0”, SCLK and SI inputs are valid, and it is possible to read data from SO. When CSB status is “1”, SCLK and SI inputs are invalid, and SO status is “Hi-Z”.

• Communication Frame

The transmitted frame by the MCU is a 40-bit structure composed of the transmission and reception discrimination (2-bit), the address (6-bit), the data (24-bit), and the CRC (8-bit). The transmission and reception discrimination (2-bit) is intended to differentiate between the transmitted and the received frame. The command (6-bit) sets various settings such as the “valid interrupt setting command”. The CRC (8-bit) outputs the result of a 39 bit to 8 bit CRC calculation. If a CRC error occurs, either when the structure of the frame is not 40-bit or when the transmission and reception discrimination bit is an error (the 33-bit of the SO frame is “H”), communication error is output and data is not recognized. As for writing, SI data is latched by internal shift register at timing of SCLK falling.

Table 12. Serial Data Input (SI)

Communication frame	39	38	37	36	35	34	33	32	31	30	29	28	27	26	25	24	
SI input bit	Register address						Setting data										
	23	22	21	20	19	18	17	16	15	14	13	12	11	10	9	8	7 to 0
	Setting data															CRC	

The received frame by the MCU has two types of bit alignment, “switch status output” and “register value output”.

The switch status output bit alignment is a 40-bit structure composed of transmission and reception discrimination (2-bit), a fixed value (1-bit), interrupt factor output (5-bit), another fixed value (1-bit), mode status output (1-bit), switch status output (22-bit), and CRC (8-bit).

Transmission and reception discrimination (2-bit) is intended to discriminate transmit and receive frame. The interrupt factor is discussed on Page 19. When an interrupt factor occurs, the corresponding bit becomes “1”. Mode status (1-bit) is “0” when set to normal mode, and it is “1” when set to sleep mode. Switch status output (22-bit) is “1” when external switch is ON, and it is “0” when external switch is OFF. The CRC (8-bit) outputs the result of a 39 bit to 8 bit CRC calculation.

The switch status is latched to the timing of CSB falling edge. The then in order of interrupt factor output, mode status and switch status output are output from SO by SCLK rising.

Table 13. Serial Data Output (SO-Switch Status Output)

Output frame	39	38	37	36	35	34	33	32	31	30	29	28	27	26	25	24	
SO output bit	1	0	0	Interrupt factor output					0	Mode	0	0	0	Switch INB2 to INB0 status output			
	23	22	21	20	19	18	17	16	15	14	13	12	11	10	9	8	7 to 0
	0	0	0	0	0	Switch INA2 to INA0 status output			0	0	0	0	Switch INZ3 to INZ0 status output				CRC

The register value output bit alignment is a 40-bit structure composed of transmission and reception discrimination (2-bit), a fixed value (1-bit), interrupt factor output (5-bit), register value output (24-bit), and CRC (8-bit).

The data is output by SO at SCLK’s rising edge after the CSB falling edge of the command following the register value output command.

The bit alignment of the register value output is shown on Table 36. The sequence of register value output is shown in Figure 11 and Figure 12.

Table 14. Serial Data Output (SO-Register Value Output)

Output frame	39	38	37	36	35	34	33	32	31	30	29	28	27	26	25	24		
SO output bit	1	0	0	Interrupt factor output					Register value output									
	23	22	21	20	19	18	17	16	15	14	13	12	11	10	9	8	7 to 0	
	Register value output															CRC		

Description of Functions - continued

The register value output command (Table 35 RIER to RMDR) is used to read-back the register value written by register write command (Table 35 IER to MDR).

Figure 11 describes the single read-back sequence. Figure 12 describes the continuous sequential read-back sequence.

<Single Read-back Sequence – Recommended Sequence>

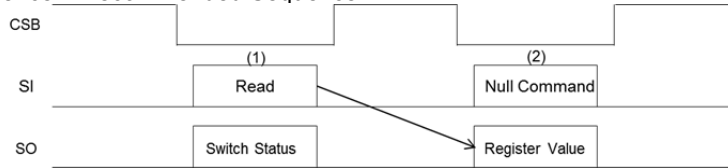

Figure 11. Single Read-back Sequence

- (1) Send the register value output command.
The switch status is output by SO.
- (2) Read the register value by sending the Null command.
The result of the register value output command (1) is output by SO.

<Continuous Sequential Read-back Sequence – Recommended Sequence>

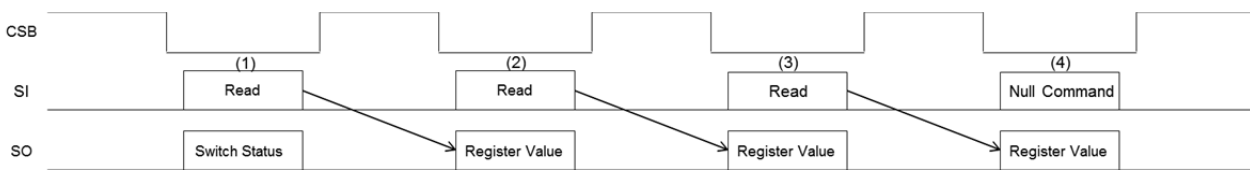

Figure 12. Continuous Sequential Read-back Sequence

- (1) Send the register value output command.
The switch status is output by SO.
- (2) Send the register value output command following (1). (The address of the register value output command does not need to be the next address.)
- (3) Send the register value output command repeatedly as needed.
The SO output at each command is the result of the previous register value output command.
- (4) Send the Null command in the end.
The register value of the previous register output command is output by SO.

3. Switch Status Output

Switch status can be sent through SO output.

Description of Functions - continued

4. Interrupt (INTB operation)

There are five interrupt factors that cause the INTB terminal to output "L". The type of interrupt factor that occurred can be checked in the SO output when CSB is "L".

INTB output will return to "H" once the interrupt factor is cleared by the rising edge of CSB. The INTB terminal is an open-drain output that is internally pulled-up to VDDI.

·Interrupt Factors

The interrupt factors are shown below:

Interrupt Factor	Interrupt flag (SO output)	Flag name
(1) Test detection	SO output bit [36]	: "test_flg"
(2) Thermal shutdown detection	SO output bit [35]	: "them_flg"
(3) Reset detection	SO output bit [34]	: "rst_flg"
(4) Communication error detection (CRC error, 40-bit frame error, or transmission and reception discrimination error)	SO output bit [33]	: "err_flg"
(5) Switch status change detection	SO output bit [32]	: "sw_flg"

(1) Test detection

The IC generates an interrupt after a transition to test mode. The TEST terminal should always be connected to ground.

(2) Thermal shutdown detection

Interrupt occurs when the thermal shutdown circuit detects a temperature higher than the allowable junction temperature inside IC.

(3) Reset detection

Interrupt occurs after the activation of Power on Reset (POR) or the transmission of the reset command. Upon POR activation, the SO output interrupt flag "rst_flg" is reflected instantly. With reset command transmission, "rst_flg" is reflected on the next command transmission.

(4) Communication error detection

Interrupt occurs due to either a CRC error, a 40-bit frame error, or a command transmission error. The interrupt flag "err_flg" is triggered by the following :

CRC error : when there is a Cyclic Redundancy Check error

40-bit frame error : when the command received is not 40-bit

Transmit and receive determination error : when the first two bits of the command received is not [39:38]="01"

(5) Switch status change detection

Interrupt occurs when switch a status changes (switch-ON→OFF or switch-OFF→ON).

·Clearing of INTB output and interrupt factor

The INTB "L" output and the interrupt factor are both cleared by the CSB rising edge during command transmission. In case a new interrupt factor occurs during command transmission, the interrupt factor is not cleared. The new interrupt factor is reflected on the next command transmission.

The interrupt factor is not cleared by the register readout that follows the register value output command.

Description of Functions - continued

5. Operating Modes

BD3376EFV-C has two types of operating mode, the normal and the sleep mode. Transition between the two modes can be done by sending the correct "Monitor Mode Transition Command". The current mode of operation can be checked through the WAKEB and the SO terminal outputs.

Monitor Mode Transition register address (0x4F): Bit [31]: 0=Normal mode, 1=Sleep mode

·Normal Mode

Normal mode operation can be set to continuous monitoring, wherein the switch status is checked by a continuously ON current source, or to intermittent monitoring, wherein the switch status is checked by a regularly ON/OFF current source.

The period of intermittent monitoring ^(Note 19) can be set according to power supply system while strobe time ^(Note 20) is common for all switch terminals.

At normal mode, WAKEB is "L" and the 30-bit of the SO output is "0".

·Sleep Mode

Sleep mode operation, like in normal mode, can be set to continuous monitoring or intermittent monitoring.

The monitoring period ^(Note 19) of intermittent monitoring can be set according to power supply system.

The strobe time ^(Note 20) is common for all switch terminals and both modes.

The difference with normal mode is that, from sleep mode, it is possible to change to normal mode automatically when interrupt occurs. (Automatic mode transition function)

At sleep mode, WAKEB is in "Hi-Z" state and its voltage level is the level of the external pull-up. The 30-bit of SO output is "1" at sleep mode.

(Note 19) Monitor period is described in Figure.13.

(Note 20) Strobe time is described in Figure.13.

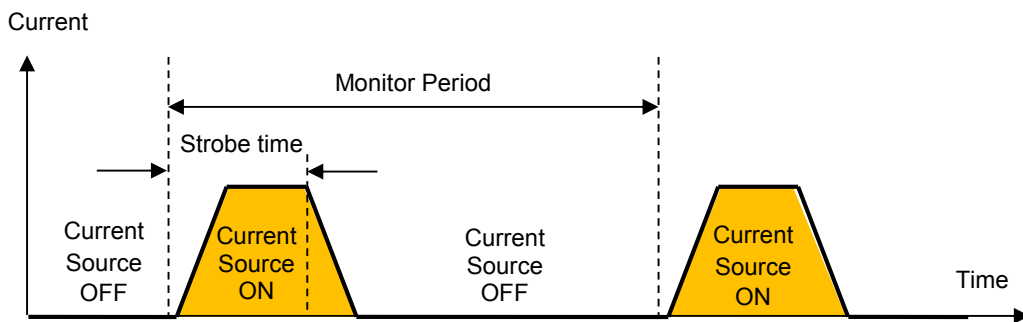

Figure 13. Intermittent Monitoring

6. Automatic Mode Transition Function

By sending the "Automatic Mode Transition Command" through setting the MIR register (0x4E) to "1", automatic transition from sleep to normal mode is possible. The conditions for a change in mode from sleep to normal to occur for both enabled and disabled "Automatic Mode Transition Function" are shown below:

·Conditions for sleep to normal mode transition when "Automatic Mode Transition Function" is enabled:

1. Normal mode transition command is sent
2. POR occurs or reset command sent (Initialization)
3. A switch status changes (The "Switch Change Interrupt Setting" should be enabled)

·Conditions for sleep to normal mode transition when "Automatic Mode Transition Function" is disabled:

1. Normal mode transition command is sent
2. POR occurs or reset command sent (Initialization)

Description of Functions - continued

[Extension Function1: Intermittent Monitoring at the Same Time (with Current Slope)]

In intermittent monitoring, it is possible to detect the status of the all switches at the same time. When all inputs are set to detect the switch status by intermittent monitoring, the wetting current has a rising and falling slope.

Normal Mode Setting Register (0x4B) : 31 bit to 28 bit is "0000" and intermittent monitoring setting
 Sleep Mode Setting Register (0x4C) : 31 bit to 28 bit is "0000" and intermittent monitoring setting

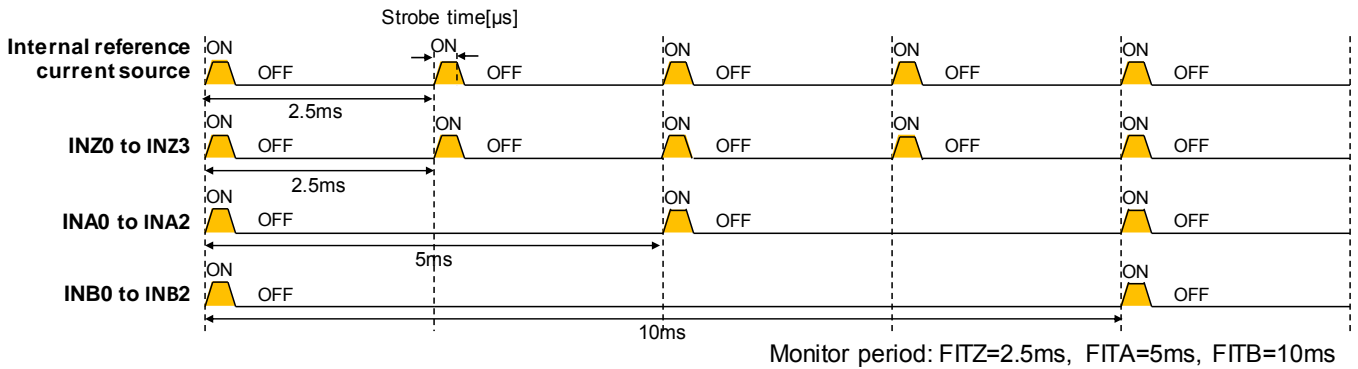

Figure 14. Intermittent Monitoring at the Same Time Example

[Extension Function 2: Sequential Monitoring by Power Supply System]

In this type of sequential monitoring, the status of the switches within a power supply system is monitored one at a time. This type has no slope. Since no two or more current sources in a power supply system are ON at the same time, radiation noise is reduced.

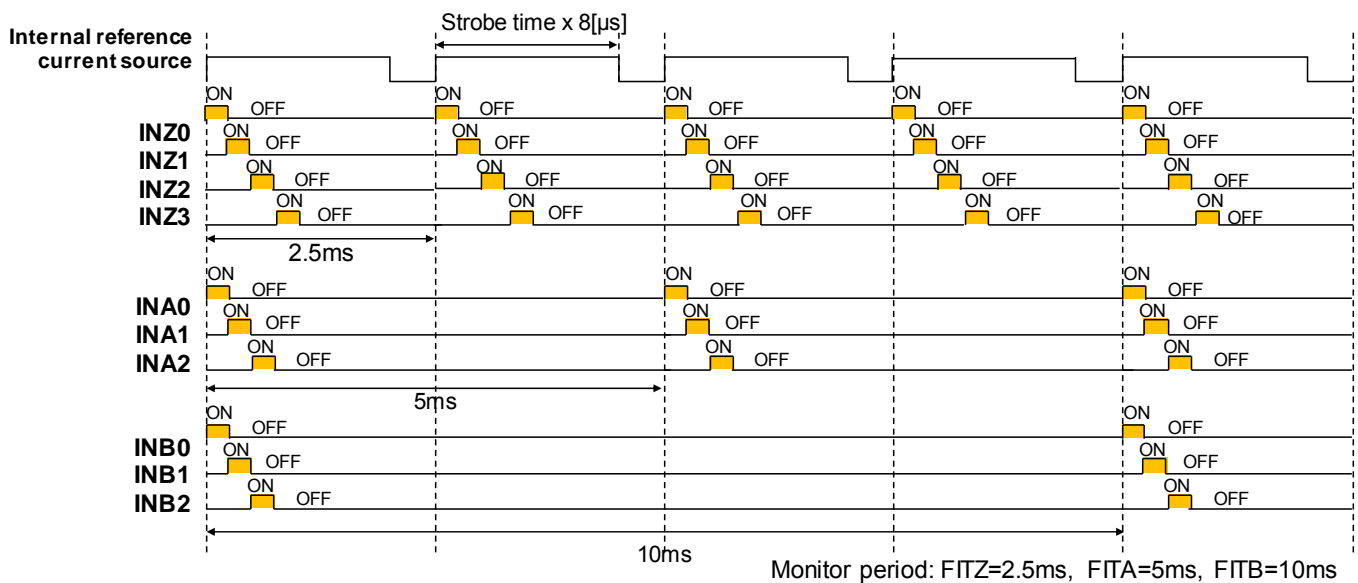

Figure 15. Sequential Monitoring by Power Supply System Example

Description of Functions - continued

[Extension Function 3: Sequential Monitoring of All Switch Terminals]

In this type of sequential monitoring, the status of all switches is monitored one at a time.

Since no two or more current sources are ON at the same time, radiation noise is reduced. This type has no slope.

The monitoring period for all switches increases by four times the monitoring period set for the INZ channels as shown in Figure 16. Uniform sequential monitoring and sequential monitoring by power supply should not be enabled at the same time. In case the two sequential monitoring methods are activated simultaneously, the method which prevails is uniform sequential monitoring.

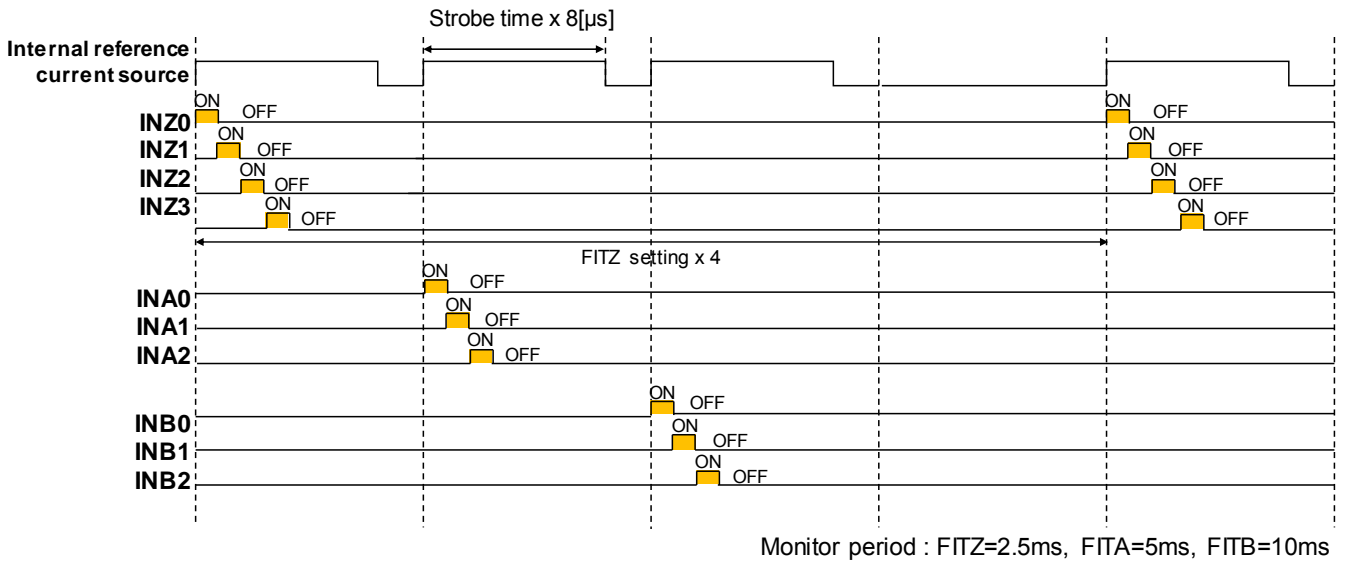

Figure 16. Sequential Monitoring of All Switch Terminals Example

Description of Functions - continued**7. WAKEB Terminal**

WAKEB is an open drain output pin.

In normal mode, its output is "L". In sleep mode, its output is "Hi-Z" and its voltage level is the level of the external pull-up.

8. Source/Sink Current Source for Switch Terminal

There are three types of switch terminal inputs with internal current source: INZ, INA, and INB. The current level can be set for each switch terminal.

·Current Source of INZ System (INZ0 to INZ3)

This current source is used to source or sink current to the external switch. The wetting current can be interchanged between pull-up and pull-down. VPUA is the power supply for the pull-up current source.

·Current Source of INA System (INA0 to INA2)

This current source is used to source current to the external switch. VPUA is the power supply

·Current Source of INB System (INB0 to INB2)

This current source is used to source current to the external switch. VPUB is the power supply.

The current source settings can be fixed by INZ current source/sink selection command, the current source setting command, and the holding current/wetting current value setting command.

Description of Functions - continued

9. Wetting Current Timer

The wetting current timer is 13ms to 22ms. This function can be enabled individually for each switch terminal. The timer starts after the switch has been detected as ON. After the 13ms to 22ms timer is finished, the wetting current (10mA/15mA) is switched to holding current (1mA/3mA/5mA). The timer is reset after the switch is turned OFF.

[Function operation1] Wetting Current Timer (Continuous Operation)

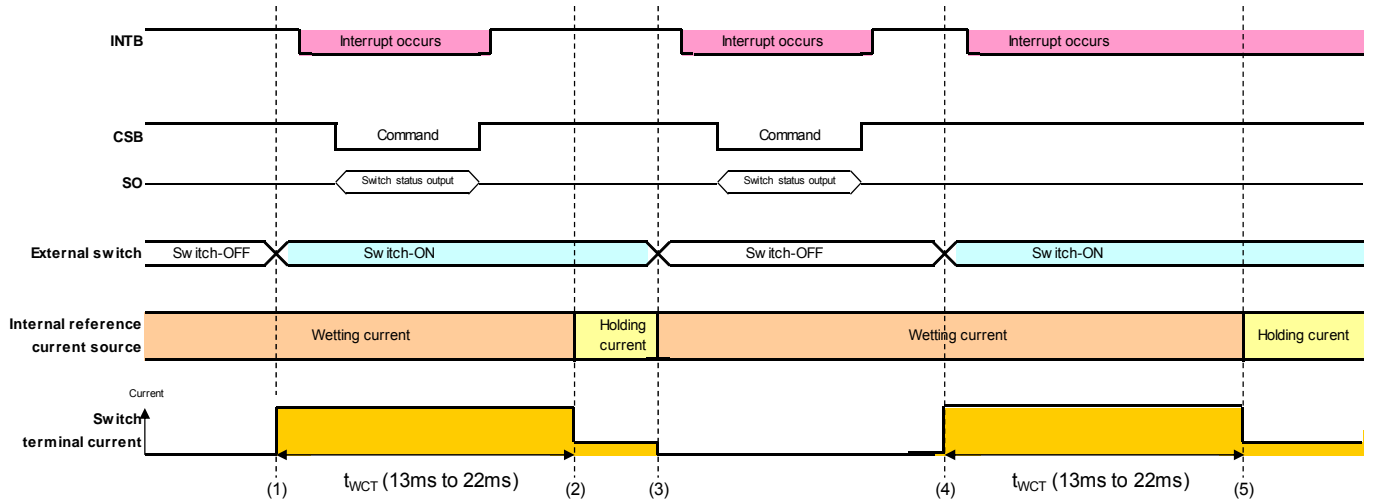

Figure 17. Wetting Current Timer (Continuous Operation)

- (1) Switch change occurs (OFF→ON), IC detects switch status change.
- (2) When ON state of the switch continues for more than 13ms to 22ms, the holding current is output.
- (3) Switch change occurs (ON→OFF).
- (4) Switch change occurs (OFF→ON), IC detects switch status change.
- (5) When ON state of the switch continues for more than 13ms to 22ms, the holding current is output.

Description of Functions - continued

[Function operation2] Wetting Current Timer (Intermittent Monitoring)

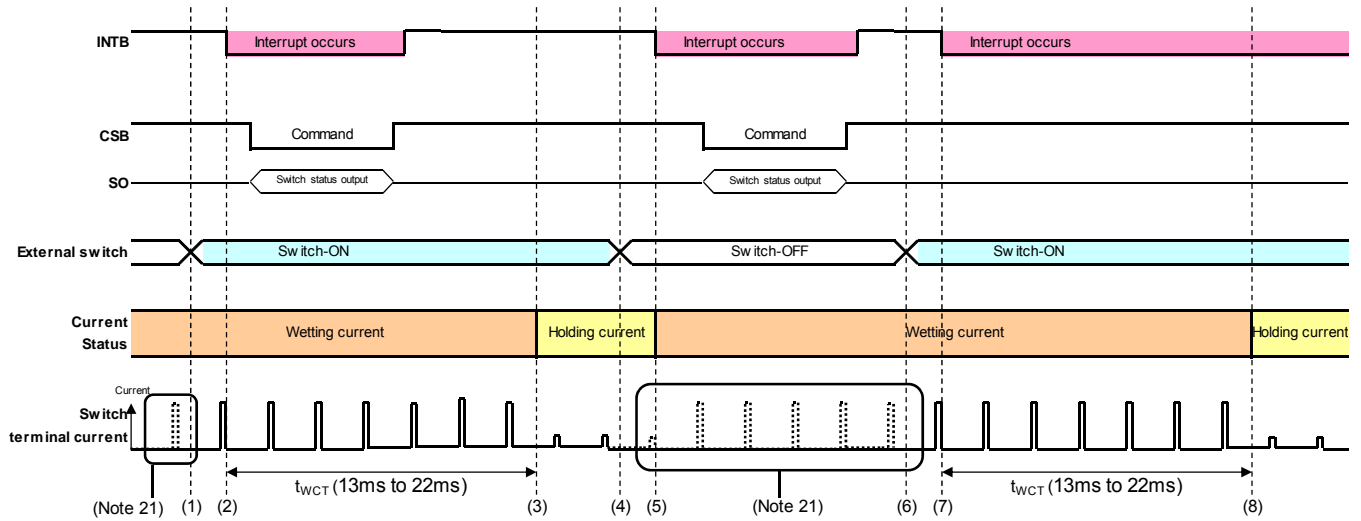

Figure 18. Wetting Current Timer (Intermittent Monitoring)

- (1) Switch change occurs (OFF→ON)
- (2) IC detects switch status change.
- (3) When ON state of the switch continues for more than 13ms to 22ms, the holding current is output.
- (4) Switch change occurs (ON→OFF).
- (5) IC detects switch status change, switch current is switched from holding current to wetting current.
- (6) Switch change occurs (OFF→ON).
- (7) IC detects switch status change.
- (8) When ON state of the switch continues for more than 13ms to 22ms, the holding current is output.

(Note 21)



The current does not flow for switch-off. This waveform shows a timing of Monitoring.

Description of Functions - continued

10. n-times Matched Filter

All switch inputs have built-in “1 to 10 times matched filters”. This function can filter the ON/OFF switch status judgment made by the internal comparator. The filter function can be enabled for each power supply system. If the register has been updated during the counting of the filter, the counting is not reset.

If the monitoring method is continuous monitoring, the switch state is filtered n-times (n: 1 to 10) multiplied by the period of the internal oscillator (32 kHz).

If the monitoring method is intermittent monitoring, the switch state is filtered n-times (n: 1 to 10) multiplied by the monitoring period.

- **Set to full-time monitor** : Sampling period is internal oscillator period : 31.25µs (Typ)

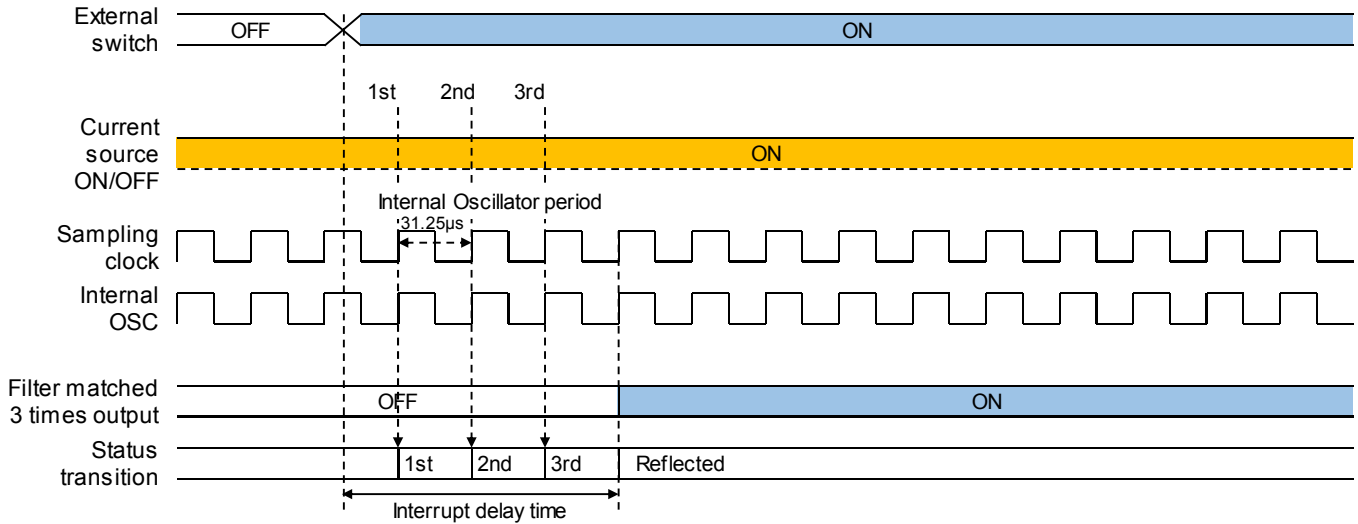

Time from Monitoring to End of Filtering:
 $\{ \text{Monitoring Period} \times (\text{Filter Number of Times} - 1) + \text{Period of Internal Oscillator} \}$
to $\{ \text{Monitoring Period} \times (\text{Filter Number of Times}) + \text{Period of Internal Oscillator} \}$

Figure 19. 3 Times Matched Filter Operation on Continuous Monitoring

- **Set to intermittent monitor** : Sampling monitor period is common with monitor period.

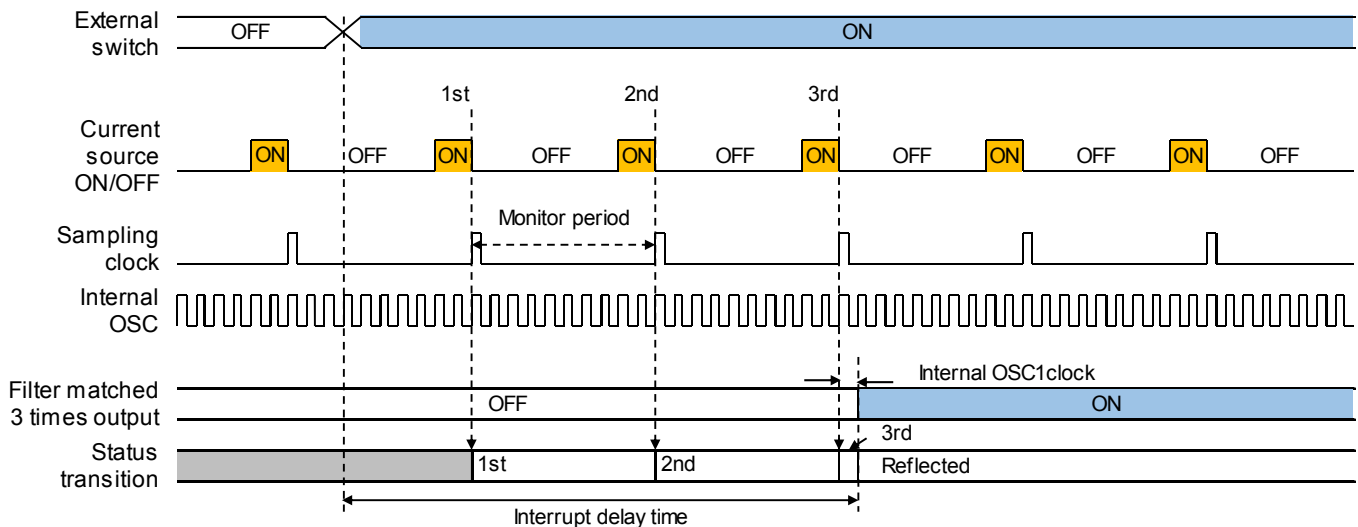

Time from Monitoring to End of Filtering:
 $\{ \text{Monitoring Period} \times (\text{Filter Number of Times} - 1) + \text{Period of Internal Oscillator} \}$
to $\{ \text{Monitoring Period} \times (\text{Filter Number of Times}) + \text{Period of Internal Oscillator} \}$

Figure 20. 3 Times Matched Filter Operation on Intermittent Monitoring

Description of Functions - continued**11. Digital Multiplexer Output (DMUX)**

The status of the selected switch input is reflected by the DMUX terminal. DMUX takes the output of the comparator on a timing determined by the monitoring method.

Only one switch terminal at a time can be selected to be reflected by DMUX.

When no switch is selected, the output of DMUX is "L".

12. Input Threshold Voltage of Switch Terminal

The switch input threshold voltage is a fraction of the AVDD ^(Note 22) voltage. It can be set to 3.0V or to 4.0V.

·3.0V Setting: $V_{TH3(HIGH)}=AVDD \times 0.6$ ($8.0V \leq VPUB \leq 26.0V$)

·4.0V Setting: $V_{TH4(HIGH)}=AVDD \times 0.8$ ($8.0V \leq VPUB \leq 26.0V$)

Table 15. Relationship between the Switch Input Threshold Voltage and the SO Output

Input type	Source or Sink	Input Voltage	Comparator output	SO serial interface bit
INZ	Source	INZ<Threshold	0	H
	Source	INZ>Threshold	1	L
	Sink	INZ<Threshold	0	L
	Sink	INZ>Threshold	1	H
INA,INB	N/A	INA,INB<Threshold	0	H
	N/A	INA,INB>Threshold	1	L

(Note 22) The output of REF5 and the input of AVDD short-circuit like the Typical Application circuit (Ref. Page 1 Figure 1).

13. Over-temperature Protection Circuit

When the junction temperature of the IC becomes higher than the thermal limit 160°C (Typ), interrupt (INTB="L") occurs and the source/sink current through the switch terminals is switched to 1mA (Min). The MCU is notified by the SO over-temperature detection flag (them_flg) changing to "1" that an irregularity in temperature has occurred. When the junction temperature of the IC has fallen below 140°C (Typ), interrupt is cleared on the next command transmission and the wetting current level returns to what was set on the registers.

Notice: The over-temperature detection value, 155°C to 175°C(Typ), and the hysteresis temperature, 10°C to 30°C(Typ), were not tested in shipment test. Also, the over-temperature protection circuit operates beyond the absolute maximum temperature ratings so the IC should not be used in a system where activation of the said protection function is expected.

14. Cyclic Redundancy Check (CRC)

The 7 bit to 0 bit of both the transmitted and received communication frame of the IC is the cyclic redundancy check (CRC), which is responsible for the detection of a data communication error.

If the IC received a CRC error, asserts interruption (INTB="L") and error flag ("err_flg") to SO output. SO output becomes "H" on the next communication to notify the MCU of the error. A command that has a CRC error is not a valid command.

The CRC generation polynomial is

$$X^8 + X^5 + X^4 + 1.$$

Command Description

Each Command has two types of functions. One is to write a value to a register. The other is to read back the register value which was written by the write command. The function to be used is set by the 37-bit of each command. (The Null and Reset commands don't include the register value output command because they don't write in the registers.)
 In the command descriptions below, the Write Command is for writing a value to a register and the read command is for reading back a register value.

1. Null Command

This command is a read only command that allows the user to monitor interruption and switch status.

Table 16. Null Command

Command 0:"L", 1:"H", x don't care		Register address								Setting data								
		39	38	37	36	35	34	33	32	31	30	29	28	27	26	25	24	
Null Command (Read Only)	IRC	0	1	0	0	0	0	0	0	x	x	x	x	x	x	x	x	
		Setting data															CRC	
		23	22	21	20	19	18	17	16	15	14	13	12	11	10	9	8	7 to 0
		x	x	x	x	x	x	x	x	x	x	x	x	x	x	x	x	CRC

2. Interrupt Notification of Switch Change Setting Command

This command allows the user to configure interrupt sources for the INTB pin. Specifically, this command allows the user to individually configure which switches trigger an interrupt on INTB by enabling or disabling the IEBn, IEAn, and IEZn setting bits shown below.
 The SO output will return the switch status depending on the settings stored at the next CSB falling edge.

Table 17. Interrupt Notification of Switch Change Setting Command

Command 0:"L", 1:"H", x don't care		Register address								Setting data								
		39	38	37	36	35	34	33	32	31	30	29	28	27	26	25	24	
Interrupt Notification of Switch Change Setting	IER	0	1	W/R	0	0	0	0	1	x	x	x	x	x	IEB2	IEB1	IEB0	
		Setting data															CRC	
		23	22	21	20	19	18	17	16	15	14	13	12	11	10	9	8	7 to 0
		x	x	x	x	x	IEA2	IEA1	IEA0	x	x	x	x	IEZ3	IEZ2	IEZ1	IEZ0	CRC

- IEBn (n: 2 to 0) [Default: 1] Interrupt Notification of Switch Status Change for INB System
 0: Disabled 1: Enabled
- IEAn (n: 2 to 0) [Default: 1] Interrupt Notification of Switch Status Change for INA System
 0: Disabled 1: Enabled
- IEZn (n: 3 to 0) [Default: 1] Interrupt Notification of Switch Status Change for INZ System
 0: Disabled 1: Enabled
- W/R Register Write/Read Setting
 0: Write 1: Read

3. Comparator Operation Control Command

This command allows the user to individually enable or disable the switch terminal comparator for each switch input. When a switch input's comparator is disabled through this register, both the corresponding settings available for that switch input within the "Interrupt Notification of Switch Change Setting Command" and the "Source/Sink Current Setting Command" are invalid.
 When the comparator is active, the switch status output does not depend on whether the wetting current is set to source or sink. The switch status output is "1" when the switch is ON and "0" when the switch is OFF.
 When the comparator is set to disabled, the switch status is undefined.

Table 18. Comparator Operation Control Command

Command 0:"L", 1:"H", x don't care		Register address								Setting data								
		39	38	37	36	35	34	33	32	31	30	29	28	27	26	25	24	
Comparator Operation Control	CMR	0	1	W/R	0	0	0	1	0	x	x	x	x	x	CMB2	CMB1	CMB0	
		Setting data															CRC	
		23	22	21	20	19	18	17	16	15	14	13	12	11	10	9	8	7 to 0
		x	x	x	x	x	CMA2	CMA1	CMA0	x	x	x	x	CMZ3	CMZ2	CMZ1	CMZ0	CRC

- CMBn (n: 2 to 0) [Default: 1] Comparator Operation for INB System
 0: Disabled 1: Enabled
- CMA n (n: 2 to 0) [Default: 1] Comparator Operation for INA System
 0: Disabled 1: Enabled
- CMZn (n: 3 to 0) [Default: 1] Comparator Operation for INZ System
 0: Disabled 1: Enabled
- W/R Register Write/Read Setting
 0: Write 1: Read

Command Description - continued

4. Comparator Threshold Selection Command

This command allows the user to set the comparator threshold of the switch terminals.

Switch detection threshold selection is available for each power supply system (See CTB, CTA and CTZ settings shown below).

Table 19. Comparator Threshold Selection Command

Command 0:"L", 1:"H", x don't care		Register address								Setting data								
		39	38	37	36	35	34	33	32	31	30	29	28	27	26	25	24	
Comparator Threshold Selection	CTR	0	1	W/R	0	0	0	1	1	CTB	CTA	CTZ	x	x	x	x	x	
		Setting data															CRC	
		23	22	21	20	19	18	17	16	15	14	13	12	11	10	9	8	7 to 0
		x	x	x	x	x	x	x	x	x	x	x	x	x	x	x	x	CRC

- CTB [Default: 0] Comparator Threshold for INB System
0: 3.0V 1: 4.0V
- CTA [Default: 0] Comparator Threshold for INA System
0: 3.0V 1: 4.0V
- CTZ [Default: 0] Comparator Threshold for INZ System
0: 3.0V 1: 4.0V
- W/R Register Write/Read Setting
0: Write 1: Read

5. INZ Current Source/Sink Selection Command

This command allows the user to select the current configuration, whether source (internal pull-up current source) or sink (internal pull-down current source), through the INZ input switch terminals.

Table 20. INZ Current Source/Sink Selection Command

Command 0:"L", 1:"H", x don't care		Register address								Setting data								
		39	38	37	36	35	34	33	32	31	30	29	28	27	26	25	24	
INZ Current Source/Sink Selection	PUDR	0	1	W/R	0	0	1	0	0	x	x	x	x	x	x	x	x	
		Setting data															CRC	
		23	22	21	20	19	18	17	16	15	14	13	12	11	10	9	8	7 to 0
		x	x	x	x	x	x	x	x	x	x	x	x	PUD3	PUD2	PUD1	PUD0	CRC

- PUDn (n: 3 to 0) [Default: 0] Source or Sink Selection for INZ System
0: Source (Internal Pull-up Current Source)
1: Sink (Internal Pull-down Current Source)
- W/R Register Write/Read Setting
0: Write 1: Read

6. Current Source Activation Command

This command allows the user to enable or disable the wetting current sources at the switch input terminals. The current sources can be set to ON or OFF per power supply system.

The output current level is determined by the "Holding Current / Wetting Current Value Setting Command" discussed in section 7 .

If an external current source is used, the comparator should be enabled (see section 3) and the internal current source should be disabled using this register.

Table 21. Current Source Activation Command

Command 0:"L", 1:"H", x don't care		Register address								Setting data								
		39	38	37	36	35	34	33	32	31	30	29	28	27	26	25	24	
Current Source Activation	CER	0	1	W/R	0	0	1	0	1	CEB	CEA	CEZ	x	x	x	x	x	
		Setting data															CRC	
		23	22	21	20	19	18	17	16	15	14	13	12	11	10	9	8	7 to 0
		x	x	x	x	x	x	x	x	x	x	x	x	x	x	x	x	CRC

- CEB [Default: 0] Current Sources of INB System
0: OFF 1: ON
- CEA [Default: 0] Current Sources of INA System
0: OFF 1: ON
- CEZ [Default: 0] Current source of INZ System
0: OFF 1: ON
- W/R Register Write/Read Setting
0: Write 1: Read

Command Description - continued

7. Holding Current / Wetting Current Level Selection Command

This command allows the user to select the output level of each current source. This command also has arguments to set both the holding and the wetting current.

The holding current can be set to 1mA, 3mA, or 5mA.

The wetting current can be set to OFF ("Hi-Z"), 1mA, 3mA, 5mA (set to holding current), 10mA, or 15mA.

Unlike holding current, wetting current output levels can be set individually for each switch terminal.

Table 22. Holding Current / Wetting Current Level Selection Command (LSB)

Command 0:"L", 1:"H", x don't care		Register address								Setting data							
		39	38	37	36	35	34	33	32	31	30	29	28	27	26	25	24
Holding Current / Wetting Current Level Selection (LSB)	LCR	0	1	W/R	0	0	1	1	0	CRH1	CRH0	x	x	x	LCB2	LCB1	LCB0
Setting data																	
23	22	21	20	19	18	17	16	15	14	13	12	11	10	9	8	7 to 0	
x	x	x	x	x	LCA2	LCA1	LCA0	x	x	x	x	LCZ3	LCZ2	LCZ1	LCZ0	CRC	

Table 23. Holding Current / Wetting Current Level Selection Command (MSB)

Command 0:"L", 1:"H", x don't care		Register address								Setting data							
		39	38	37	36	35	34	33	32	31	30	29	28	27	26	25	24
Holding Current / Wetting Current Level Selection (MSB)	MCR	0	1	W/R	0	0	1	1	1	x	x	x	x	x	MCB2	MCB1	MCB0
Setting data																	
23	22	21	20	19	18	17	16	15	14	13	12	11	10	9	8	7 to 0	
x	x	x	x	x	MCA2	MCA1	MCA0	x	x	x	x	MCZ3	MCZ2	MCZ1	MCZ0	CRC	

- CRH [1:0] [Default: 00] Holding Current Value
00: 1mA 01: 3mA
10: 5mA 11: 1mA
- {MCBn (n: 2 to 0), LCBn (n: 2 to 0)} [Default: 01] Wetting Current Value for INB System
00: Invalid(Hi-Z) 01: 1mA/3mA/5mA(Holding Current Value)
10: 10mA 11: 15mA
- {MCA n (n: 2 to 0), LCA n (n: 2 to 0)} [Default: 01] Wetting Current Value for INA System
00: Invalid(Hi-Z) 01: 1mA/3mA/5mA(Holding Current Value)
10: 10mA 11: 15mA
- {MCZn (n: 3 to 0), LCZn (n: 3 to 0)} [Default: 01] Wetting Current Value for INZ System
00: Invalid(Hi-Z) 01: 1mA/3mA/5mA(Holding Current Value)
10: 10mA 11: 15mA
- W/R Register Write/Read Setting
0: Write 1: Read

8. Wetting Current Operation Control Command

This command allows the user to enable or disable the "wetting current timer".

This "wetting current timer" counts 13ms to 22ms after the switch has been closed and the wetting current changes to holding current (1mA/3mA/5mA). The timer is reset when the switch is turned off.

If the wetting current level is the same as the holding current level, the timer does not operate.

The wetting current timer can be enabled or disabled individually for each switch terminal.

Table 24. Wetting Current Operation Control Command

Command 0:"L", 1:"H", x don't care		Register address								Setting data							
		39	38	37	36	35	34	33	32	31	30	29	28	27	26	25	24
Wetting Current Operation Control	WTR	0	1	W/R	0	1	0	0	0	x	x	x	x	x	WTB2	WTB1	WTB0
Setting data																	
23	22	21	20	19	18	17	16	15	14	13	12	11	10	9	8	7 to 0	
x	x	x	x	x	WTA2	WTA1	WTA0	x	x	x	x	WTZ3	WTZ2	WTZ1	WTZ0	CRC	

- WTBn (n: 2 to 0) [Default: 0] Wetting Current Timer for INB System
0: Disabled 1: Enabled
- WTAn (n: 2 to 0) [Default: 0] Wetting Current Timer for INA System
0: Disabled 1: Enabled
- WTZn (n: 3 to 0) [Default: 0] Wetting Current Timer for INZ System
0: Disabled 1: Enabled
- W/R Register Write/Read Setting
0: Write 1: Read

Command Description - continued

9. n-times Matched Filter Activation Control Command

This command allows the user to enable or disable the n-times matched LPF.

If this function is enabled, the switch output is updated only after the comparator output has been sampled n-times (where n = 1 to 10) and if all sampled comparator outputs match.

This command allows for each switch terminal to be enabled or disabled individually.

Table 25. n-times Matched Filter Activation Control Command

Command		Register address								Setting data							
0:"L", 1:"H", x don't care		39	38	37	36	35	34	33	32	31	30	29	28	27	26	25	24
n-Times Matched Filter Activation Control	DFR	0	1	W/R	0	1	0	0	1	DFB2	DFB1	DFB0	DFA2	DFA1	DFA0	DFZ2	DFZ1
																CRC	
																7 to 0	
																CRC	

DFB [3:0] [Default: 0000]

n-times Matched LPF Settings for INB System

- 0000 : Disabled (1 time) 0001 : 2 times
- 0010 : 3 times 0011 : 4 times
- 0100 : 5 times 0101 : 6 times
- 0110 : Disabled (1 time) 0111 : Disabled (1 time)
- 1000 : Disabled (1 time) 1001 : 7 times
- 1010 : 8 times 1011 : 9 times
- 1100 : 10 times 1101 : Disabled (1 time)
- 1110 : Disabled (1 time) 1111 : Disabled (1 time)

DFA [3:0] [Default: 0000]

n-times Matched LPF Settings for INA System

- 0000 : Disabled (1 time) 0001 : 2 times
- 0010 : 3 times 0011 : 4 times
- 0100 : 5 times 0101 : 6 times
- 0110 : Disabled (1 time) 0111 : Disabled (1 time)
- 1000 : Disabled (1 time) 1001 : 7 times
- 1010 : 8 times 1011 : 9 times
- 1100 : 10 times 1101 : Disabled (1 time)
- 1110 : Disabled (1 time) 1111 : Disabled (1 time)

DFZ [3:0] [Default: 0000]

n-times Matched LPF Settings for INZ System

- 0000 : Disabled (1 time) 0001 : 2 times
- 0010 : 3 times 0011 : 4 times
- 0100 : 5 times 0101 : 6 times
- 0110 : Disabled (1 time) 0111 : Disabled (1 time)
- 1000 : Disabled (1 time) 1001 : 7 times
- 1010 : 8 times 1011 : 9 times
- 1100 : 10 times 1101 : Disabled (1 time)
- 1110 : Disabled (1 time) 1111 : Disabled (1 time)

W/R

Register Write/Read Setting
 0: Write 1: Read

Command Description - continued

10. DMUX Setting Command

This command allows the user to enable/disable and configure selected switch output on the DMUX terminal.

The result of the chosen switch terminal's comparator is taken and output to DMUX using timing that depends on the monitoring method used.

Any switch input terminal can be connected to this DMUX pin by adjusting the DMX0 to DMX4 bits shown below.

Table 26. DMUX Setting Command

Command 0:"L", 1:"H", x don't care	Register address								Setting data								
	39	38	37	36	35	34	33	32	31	30	29	28	27	26	25	24	
DMUX Setting	DMR	0	1	W/R	0	1	0	1	0	DMX4	DMX3	DMX2	DMX1	DMX0	x	x	x

Setting data																CRC
23	22	21	20	19	18	17	16	15	14	13	12	11	10	9	8	7 to 0
x	x	x	x	x	x	x	x	x	x	x	x	x	x	x	x	CRC

Table 27. DMUX Channel Selection

31 bit to 27 bit	Selected Channel
00000	Disabled (Output is "L")
00001	INZ0
00010	INZ1
00011	INZ2
00100	INZ3
00101	Disabled (Output is "L")
00110	Disabled (Output is "L")
00111	Disabled (Output is "L")
01000	Disabled (Output is "L")
01001	INA0
01010	INA1
01011	INA2
01100	Disabled (Output is "L")
01101	Disabled (Output is "L")
01110	Disabled (Output is "L")
01111	Disabled (Output is "L")
10000	Disabled (Output is "L")
10001	INB0
10010	INB1
10011	INB2
10100	Disabled (Output is "L")
10101	Disabled (Output is "L")
10110	Disabled (Output is "L")
10111 to 11111	Disabled (Output is "L")

DMX [4:0] [Default: 00000]

DMUX Terminal Setting

- 00000 : Disabled (DMUX output is "L")
- 00001 to 00100 : INZ Selected Channel
- 00101 to 01000 : Disabled (DMUX output is "L")
- 01001 to 01011 : INA Selected Channel
- 01100 to 10000 : Disabled (DMUX output is "L")
- 10001 to 10011 : INB Selected Channel
- 10100 to 11111 : Disabled (DMUX output is "L")

W/R

Register Write/Read Setting
 0: Write 1: Read

Command Description - continued

11. Normal Mode Setting Command

This command allows the user to set the monitoring period, strobe time, and monitoring method of normal mode.

The normal mode is set after power on reset or by "Monitor Mode Transition Command".

The monitoring period can be set individually per power supply system but the strobe time is common to all switch terminals.

The monitoring method can be set continuous monitoring, intermittent monitoring at the same time, sequential monitoring by power supply system and sequential monitoring of all switch terminals.

The strobe time is limited as follows.

- When normal mode is set at 1ms monitoring period, and sequential monitoring is by power supply system, only 93.75µs strobe time is allowed. Other strobe time settings are prohibited.

- When normal mode is set at 1ms monitoring period, and sequential monitoring is for all switch terminals, only 93.75µs strobe time is allowed. Other strobe time settings are prohibited.

- Continuous Monitoring:

IC monitors switch status continuously.

Refer to the "[Basic Operation 1] Detection of switch status change (Continuous Monitoring)" section for additional details.

- Intermittent Monitoring at the Same Time:

IC monitors switch status per power supply system at the same time.

Refer to the "[Extension Function1: Intermittent Monitoring at the Same Time (with Current Slope)]" section for additional details.

- Sequential Monitoring by Power Supply System:

IC monitors switch status per switch by turns on power supply system.

Refer to the "[Extension Function 2: Sequential Monitoring by Power Supply System]" section for additional details.

- Sequential Monitoring of All Switch Terminals:

IC monitors switch status per switch by turns.

Refer to the "[Extension Function 3: Sequential Monitoring of All Switch Terminals]" section for additional details.

If both sequential and continuous monitoring are enabled at the same time, continuous monitoring will be the one implemented.

If both sequential monitoring by power supply system and sequential monitoring of all switch terminals are enabled at the same time, sequential monitoring of all switch terminals will be the one implemented.

Table 28. Normal Mode Setting Command

Command 0:"L", 1:"H", x don't care	FMR	Register address								Setting data							
		39	38	37	36	35	34	33	32	31	30	29	28	27	26	25	24
Normal Mode Setting	FMR	0	1	W/R	0	1	0	1	1	FSQ	FSQB	FSQA	FSQZ	FITB2	FITB1	FITB0	FITA2
Setting data																CRC	
23	22	21	20	19	18	17	16	15	14	13	12	11	10	9	8	7 to 0	
FITA1	FITA0	FITZ2	FITZ1	FITZ0	SVW1	SVW0	FITB3	FITA3	FITZ3	x	x	x	x	x	x	CRC	

- FSQ [Default: 0] Sequential Monitoring of All Switch Terminals
0: Disabled 1: Enabled
- FSQB [Default: 0] Sequential Monitoring by Power Supply System for INB System
0: Disabled 1: Enabled
- FSQA [Default: 0] Sequential Monitoring by Power Supply System for INA System
0: Disabled 1: Enabled
- FSQZ [Default: 0] Sequential Monitoring by Power Supply System for INZ System
0: Disabled 1: Enabled

- FIT*[3:0] (*: B, A, Z) [Default: 0000] Monitoring Period for Normal Mode
0000: Continuous Monitoring 0001: 2.5ms
0010: 5ms 0011: 10ms
0100: 20ms 0101: 30ms
0110: 40ms 0111: 50ms
1000: 100ms 1001: 1ms
1010 to 1111: Setting prohibited

- SVW [1:0] [Default: 01] Strobe Time
00: 93.75µs 01: 125µs
10: 187.5µs 11: 250µs

- W/R Register Write/Read Setting
0: Write 1: Read

Command Description - continued

12. Sleep Mode Setting Command

This command allows the user to set the monitoring period and monitoring method of sleep mode.

The sleep mode is set by "Monitor Mode Transition Command".

The strobe time of sleep mode is the same as the normal mode.

About the monitoring period and monitoring method, refer to the "Normal Mode Setting Command" discussed in section 11.

The strobe time is limited as follows.

·When normal mode is set at 1ms monitoring period, and sequential monitoring is by power supply system, only 93.75µs strobe time is allowed. Other strobe time settings are prohibited.

·When normal mode is set at 1ms monitoring period, and sequential monitoring is for all switch terminals, only 93.75µs strobe time is allowed. Other strobe time settings are prohibited.

Table 29. Sleep Mode Setting Command

Command 0:"L", 1:"H", x: don't care		Register address								Setting data							
		39	38	37	36	35	34	33	32	31	30	29	28	27	26	25	24
Sleep Mode Setting	SMR	0	1	W/R	0	1	1	0	0	SSQ	SSQB	SSQA	SSQZ	SITB2	SITB1	SITB0	SITA2
Setting data																	CRC
23	22	21	20	19	18	17	16	15	14	13	12	11	10	9	8	7 to 0	
SITA1	SITA0	SITZ2	SITZ1	SITZ0	x	x	SITB3	SITA3	SITZ3	x	x	x	x	x	x	CRC	

- SSQ [Default: 0] Sequential Monitoring of All Switch Terminals
0: Disabled 1: Enabled
- SSQB [Default: 0] Sequential Monitoring by Power Supply System for INB System
0: Disabled 1: Enabled
- SSQA [Default: 0] Sequential Monitoring by Power Supply System for INA System
0: Disabled 1: Enabled
- SSQZ [Default: 0] Sequential Monitoring by Power Supply System for INZ System
0: Disabled 1: Enabled

- SIT*[3:0] (*: B, A, Z) [Default: 0111] Monitoring Period for Sleep Mode
0000: Continuous Monitoring 0001: 2.5ms
0010: 5ms 0011: 10ms
0100: 20ms 0101: 30ms
0110: 40ms 0111: 50ms
1000: 100ms 1001: 1ms
1010 to 1111: Setting prohibited

- W/R Register Write/Read Setting
0: Write 1: Read

Command Description – continued

13. Detection Edge Selection Command

This command allows the user to configure interrupt trigger of switches for the INTB pin.

The interrupt trigger can be set to only the falling edge^(Note 23) or both the rising and falling edges of the switch input voltage per power supply system.

If only the falling edge is selected, the INTB pin not changes by the rising edges of switch input voltage.

(Note 23) If the INZ current "Source Setting" is enabled, the falling edge of the switch input terminal is seen when the external switch is turned on. If the INZ current "Sink Setting" is enabled, the falling edge is seen when the external switch is turned off.

Table 30. Detection Edge Selection Command

Command 0:"L", 1:"H", x don't care		Register address								Setting data							
		39	38	37	36	35	34	33	32	31	30	29	28	27	26	25	24
Detection Edge Selection	ISR	0	1	W/R	0	1	1	0	1	ISB	ISA	ISZ	x	x	x	x	x
Setting data																	CRC
23	22	21	20	19	18	17	16	15	14	13	12	11	10	9	8	7 to 0	
x	x	x	x	x	x	x	x	x	x	x	x	x	x	x	x	CRC	

ISB [Default: 1] Switch edge where interrupt occurs for INB System
 0: Only Falling Edge 1: Both Edges

ISA [Default: 1] Switch edge where interrupt occurs for INA System
 0: Only Falling Edge 1: Both Edges

ISZ [Default: 1] Switch edge where interrupt occurs for INZ System
 0: Only Falling Edge 1: Both Edges

W/R Register Write/Read Setting
 0: Write 1: Read

14. Automatic Mode Transition Command

This command allows the user to configure the mode to automatically change by a change in switch status.

If the automatic transition is enabled, the monitoring period and monitoring method are changed to normal mode settings when it detects a change in switch status on sleep.

Refer to the "[Basic Operation 4] Sleep Mode Operation (Automatic Transition to Normal Mode)" section for additional details on how sleep mode operations works for this IC.

Table 31. Automatic Mode Transition Command

Command 0:"L", 1:"H", x don't care		Register address								Setting data							
		39	38	37	36	35	34	33	32	31	30	29	28	27	26	25	24
Automatic Mode Transition	MIR	0	1	W/R	0	1	1	1	0	MR_IER	x	x	x	x	x	x	x
Setting data																	CRC
23	22	21	20	19	18	17	16	15	14	13	12	11	10	9	8	7 to 0	
x	x	x	x	x	x	x	x	x	x	x	x	x	x	x	x	CRC	

MR_IER [Default: 1] Automatic Mode Transition
 0: Disabled 1: Enabled

W/R Register Write/Read Setting
 0: Write 1: Read

15. Monitor Mode Transition Command

This command allows the user to change the mode of operation between normal and sleep.

Refer to the "[Basic Operation 3] Sleep Mode Operation (Manual Transition)" section for additional details on how sleep mode operations works for this IC.

Table 32. Monitor Mode Transition Command

Command 0:"L", 1:"H", x don't care		Register address								Setting data							
		39	38	37	36	35	34	33	32	31	30	29	28	27	26	25	24
Monitor Mode Transition	MDR	0	1	W/R	0	1	1	1	1	MDC	x	x	x	x	x	x	x
Setting data																	CRC
23	22	21	20	19	18	17	16	15	14	13	12	11	10	9	8	7 to 0	
x	x	x	x	x	x	x	x	x	x	x	x	x	x	x	x	CRC	

MDC [Default: 0] Monitoring mode
 0: Normal Mode 1: Sleep Mode

W/R Register Write/Read Setting
 0: Write 1: Read

Command Description - continued

16. Reset Command

This command allows the user to reset the registers to their initial settings. After the reset command has been sent, the physical interrupt pin goes to low (INTB="L").

Table 33. Reset Command

Command 0:"L", 1:"H", x don't care		Register address								Setting data							
		39	38	37	36	35	34	33	32	31	30	29	28	27	26	25	24
Reset	RST	0	1	0	1	1	1	1	1	x	x	x	x	x	x	x	x

Setting data																CRC
23	22	21	20	19	18	17	16	15	14	13	12	11	10	9	8	7 to 0
x	x	x	x	x	x	x	x	x	x	x	x	x	x	x	x	CRC

17. TEST Command

This command is used to enter test mode, which is only possible when the TEST pin is "H".

Table 34. TEST Command

Command 0:"L", 1:"H", x don't care		Register address								Setting data							
		39	38	37	36	35	34	33	32	31	30	29	28	27	26	25	24
TEST	TSR	0	1	1	1	1	0	0	1	TSS7	TSS6	TSS5	TSS4	TSS3	TSS2	TSS1	TSS0

Setting data																CRC
23	22	21	20	19	18	17	16	15	14	13	12	11	10	9	8	7 to 0
x	x	x	x	x	x	x	x	x	x	x	x	x	x	x	x	CRC

18. Register Map

Table 35. Register Map

Register Name	Symbol	Register Address	Setting Data Name (def.: Default Setting)																								CRC		
			31	30	29	28	27	26	25	24	23	22	21	20	19	18	17	16	15	14	13	12	11	10	9	8		7 to 0	
Null Command(Read Only)	IRC	0x40																									CRC		
Interrupt Notification of Switch Change Setting Command [Default: Valid]	IER	0x41							IEB2 (def.1)	IEB1 (def.1)	IEB0 (def.1)						IEA2 (def.1)	IEA1 (def.1)	IEA0 (def.1)					IEZ3 (def.1)	IEZ2 (def.1)	IEZ1 (def.1)	IEZ0 (def.1)	CRC	
Comparator Operation Control Command [Default: Valid]	CMR	0x42							CMB2 (def.1)	CMB1 (def.1)	CMB0 (def.1)						CMA2 (def.1)	CMA1 (def.1)	CMA0 (def.1)					CMZ3 (def.1)	CMZ2 (def.1)	CMZ1 (def.1)	CMZ0 (def.1)	CRC	
Comparator Threshold Selection Command [Default: 3.0V]	CTR	0x43	CTB (def.0)	CTA (def.0)	CTZ (def.0)																							CRC	
INZ Current Source/Sink Selection Command [Default: Source]	PUDR	0x44																							PUD3 (def.0)	PUD2 (def.0)	PUD1 (def.0)	PUD0 (def.0)	CRC
Current Source Activation Command [Default: OFF (Invalid)]	CER	0x45	CEB (def.0)	CEA (def.0)	CEZ (def.0)																							CRC	
Holding Current / Wetting Current Level Selection Command (LSB) [Default: Wetting current =1mA (Holding current)]	LCR	0x46	CRH1 (def.0)	CRH0 (def.0)				LCB2 (def.1)	LCB1 (def.1)	LCB0 (def.1)							LCA2 (def.1)	LCA1 (def.1)	LCA0 (def.1)					LCZ3 (def.1)	LCZ2 (def.1)	LCZ1 (def.1)	LCZ0 (def.1)	CRC	
Holding Current / Wetting Current Level Selection Command (MSB) [Default: Wetting current =1mA (Holding current)]	MCR	0x47						MCB2 (def.0)	MCB1 (def.0)	MCB0 (def.0)							MCA2 (def.0)	MCA1 (def.0)	MCA0 (def.0)					MCZ3 (def.0)	MCZ2 (def.0)	MCZ1 (def.0)	MCZ0 (def.0)	CRC	
Wetting Current Operation Control Command [Default: Invalid]	WTR	0x48						WTB2 (def.0)	WTB1 (def.0)	WTB0 (def.0)							WTA2 (def.0)	WTA1 (def.0)	WTA0 (def.0)					WTZ3 (def.0)	WTZ2 (def.0)	WTZ1 (def.0)	WTZ0 (def.0)	CRC	
n-times Matched Filter Activation Control Command [Default: Invalid]	DFR	0x49	DFB2 (def.0)	DFB1 (def.0)	DFB0 (def.0)	DFA2 (def.0)	DFA1 (def.0)	DFA0 (def.0)	DFZ2 (def.0)	DFZ1 (def.0)	DFZ0 (def.0)	DFB3 (def.0)	DFA3 (def.0)	DFZ3 (def.0)														CRC	
DMUX Setting Command [Default: Invalid]	DMR	0x4A	DMX4 (def.0)	DMX3 (def.0)	DMX2 (def.0)	DMX1 (def.0)	DMX0 (def.0)																						CRC
Normal Mode Setting Command [Default: Full-time Monitoring,Strobe time:125µs, Sequential Monitoring is invalid]	FMR	0x4B	FSQ (def.0)	FSQB (def.0)	FSQA (def.0)	FSQZ (def.0)	FITB2 (def.0)	FITB1 (def.0)	FITB0 (def.0)	FITA2 (def.0)	FITA1 (def.0)	FITA0 (def.0)	FITZ2 (def.0)	FITZ1 (def.0)	FITZ0 (def.0)	SWH1 (def.0)	SWH0 (def.1)	FITB3 (def.0)	FITA3 (def.0)	FITZ3 (def.0)									CRC
Sleep Mode Setting Command [Default: Monitoring period:50ms,Sequential Monitoring is invalid]	SMR	0x4C	SSQ (def.0)	SSQB (def.0)	SSQA (def.0)	SSQZ (def.0)	SITB2 (def.1)	SITB1 (def.1)	SITB0 (def.1)	SITA2 (def.1)	SITA1 (def.1)	SITA0 (def.1)	SITZ2 (def.1)	SITZ1 (def.1)	SITZ0 (def.1)			SITB3 (def.0)	SITA3 (def.0)	SITZ3 (def.0)									CRC
Detection Edge Selection Command [Default: Both edges]	ISR	0x4D	ISB (def.1)	ISA (def.1)	ISZ (def.1)																								CRC
Automatic Mode Transition Command [Default: Automatic Mode transition is valid]	MIR	0x4E	MIR (def.1)																										CRC
Monitor Mode Transition Command [Default: Normal mode]	MDR	0x4F	MDC (def.0)																										CRC
Reset Command	RST	0x5F																											CRC
Interrupt Notification of Switch Change Setting Command Read	RIER	0x61																											CRC
Comparator Operation Control Command Read	RCMR	0x62																											CRC
Comparator Threshold Selection Command Read	RCTR	0x63																											CRC
INZ Current Source/Sink Selection Command Read	RPUDR	0x64																											CRC
Current Source Activation Command Read	RCER	0x65																											CRC
Holding Current / Wetting Current Level Selection Command (LSB) Read	RLCR	0x66																											CRC
Holding Current / Wetting Current Level Selection Command (MSB) Read	RMCR	0x67																											CRC
Wetting Current Operation Control Command Read	RWTR	0x68																											CRC
n-times Matched Filter Activation Control Command Read	RDFR	0x69																											CRC
DMUX Setting Command Read	RDMR	0x6A																											CRC
Normal Mode Setting Command Read	RFMR	0x6B																											CRC
Sleep Mode Setting Command Read	RSMR	0x6C																											CRC
Detection Edge Selection Command Read	RISR	0x6D																											CRC
Automatic Mode Transition Command Read	RMIR	0x6E																											CRC
Monitor Mode Transition Command Read	RMDR	0x6F																											CRC
TEST Command [Default: Invalid]	TSR	0x79	TSS7 (def.0)	TSS6 (def.0)	TSS5 (def.0)	TSS4 (def.0)	TSS3 (def.0)	TSS2 (def.0)	TSS1 (def.0)	TSS0 (def.0)																		CRC	

Command Description - continued

Table 36. Register Map (SO Bit Alignment)

Register Name	Symbol	Read Data Name																												CRC
		39 to 32	31	30	29	28	27	26	25	24	23	22	21	20	19	18	17	16	15	14	13	12	11	10	9	8	7 to 0			
Interrupt Notification of Switch Change Setting Command Read	RIER	"100", Interrupt Factor	0	0	0	0	0	IEB2 (def.1)	IEB1 (def.1)	IEB0 (def.1)	0	0	0	0	0	IEA2 (def.1)	IEA1 (def.1)	IEA0 (def.1)	0	0	0	0	0	0	IEZ3 (def.1)	IEZ2 (def.1)	IEZ1 (def.1)	IEZ0 (def.1)	CRC	
Comparator Operation Control Command Read	RCMR	"100", Interrupt Factor	0	0	0	0	0	CMB2 (def.1)	CMB1 (def.1)	CMB0 (def.1)	0	0	0	0	0	CMA2 (def.1)	CMA1 (def.1)	CMA0 (def.1)	0	0	0	0	0	0	CMZ3 (def.1)	CMZ2 (def.1)	CMZ1 (def.1)	CMZ0 (def.1)	CRC	
Comparator Threshold Selection Command Read	RCTR	"100", Interrupt Factor	CTB (def.0)	CTA (def.0)	CTZ (def.0)	0	0	0	0	0	0	0	0	0	0	0	0	0	0	0	0	0	0	0	0	0	0	0	CRC	
INZ Current Source/Sink Selection Command Read	RPUDR	"100", Interrupt Factor	0	0	0	0	0	0	0	0	0	0	0	0	0	0	0	0	0	0	0	0	0	0	PUD3 (def.0)	PUD2 (def.0)	PUD1 (def.0)	PUD0 (def.0)	CRC	
Current Source Activation Command Read	RCER	"100", Interrupt Factor	CEB (def.0)	CEA (def.0)	CEZ (def.0)	0	0	0	0	0	0	0	0	0	0	0	0	0	0	0	0	0	0	0	0	0	0	0	CRC	
Holding Current / Wetting Current Level Selection Command (LSB) Read	RLCR	"100", Interrupt Factor	CRH1 (def.0)	CRH0 (def.0)	0	0	0	LCB2 (def.1)	LCB1 (def.1)	LCB0 (def.1)	0	0	0	0	0	LCA2 (def.1)	LCA1 (def.1)	LCA0 (def.1)	0	0	0	0	0	0	LCZ3 (def.1)	LCZ2 (def.1)	LCZ1 (def.1)	LCZ0 (def.1)	CRC	
Holding Current / Wetting Current Level Selection Command (MSB) Read	RMCR	"100", Interrupt Factor	0	0	0	0	0	MCB2 (def.0)	MCB1 (def.0)	MCB0 (def.0)	0	0	0	0	0	MCA2 (def.0)	MCA1 (def.0)	MCA0 (def.0)	0	0	0	0	0	0	MCZ3 (def.0)	MCZ2 (def.0)	MCZ1 (def.0)	MCZ0 (def.0)	CRC	
Wetting Current Operation Control Command Read	RWTR	"100", Interrupt Factor	0	0	0	0	0	WTB2 (def.0)	WTB1 (def.0)	WTB0 (def.0)	0	0	0	0	0	WTA2 (def.0)	WTA1 (def.0)	WTA0 (def.0)	0	0	0	0	0	0	WTZ3 (def.0)	WTZ2 (def.0)	WTZ1 (def.0)	WTZ0 (def.0)	CRC	
n-times Matched Filter Activation Control Command Read	RDFR	"100", Interrupt Factor	DFB2 (def.0)	DFB1 (def.0)	DFB0 (def.0)	DFA2 (def.0)	DFA1 (def.0)	DFA0 (def.0)	DFZ2 (def.0)	DFZ1 (def.0)	DFZ0 (def.0)	DFB3 (def.0)	DFA3 (def.0)	DFZ3 (def.0)	0	0	0	0	0	0	0	0	0	0	0	0	0	0	CRC	
DMUX Setting Command Read	RDMR	"100", Interrupt Factor	DMX4 (def.0)	DMX3 (def.0)	DMX2 (def.0)	DMX1 (def.0)	DMX0 (def.0)	0	0	0	0	0	0	0	0	0	0	0	0	0	0	0	0	0	0	0	0	0	0	CRC
Normal Mode Setting Command Read	RFMR	"100", Interrupt Factor	FSQ (def.0)	FSQB (def.0)	FSQA (def.0)	FSQZ (def.0)	FITB2 (def.0)	FITB1 (def.0)	FITB0 (def.0)	FITA2 (def.0)	FITA1 (def.0)	FITA0 (def.0)	FITZ2 (def.0)	FITZ1 (def.0)	FITZ0 (def.0)	SWV1 (def.0)	SWV0 (def.0)	FITB3 (def.0)	FITA3 (def.0)	FITZ3 (def.0)	0	0	0	0	0	0	0	0	0	CRC
Sleep Mode Setting Command Read	RSMR	"100", Interrupt Factor	SSQ (def.0)	SSQB (def.0)	SSQA (def.0)	SSQZ (def.0)	SITB2 (def.1)	SITB1 (def.1)	SITB0 (def.1)	SITA2 (def.1)	SITA1 (def.1)	SITA0 (def.1)	SITZ2 (def.1)	SITZ1 (def.1)	SITZ0 (def.1)	0	0	SITB3 (def.0)	SITA3 (def.0)	SITZ3 (def.0)	0	0	0	0	0	0	0	0	0	CRC
Detection Edge Selection Command Read	RISR	"100", Interrupt Factor	ISB (def.1)	ISA (def.1)	ISZ (def.1)	0	0	0	0	0	0	0	0	0	0	0	0	0	0	0	0	0	0	0	0	0	0	0	0	CRC
Automatic Mode Transition Command Read	RMR	"100", Interrupt Factor	MR (def.1)	IER (def.1)	0	0	0	0	0	0	0	0	0	0	0	0	0	0	0	0	0	0	0	0	0	0	0	0	0	CRC
Monitor Mode Transition Command Read	RMDR	"100", Interrupt Factor	MDC (def.0)	0	0	0	0	0	0	0	0	0	0	0	0	0	0	0	0	0	0	0	0	0	0	0	0	0	0	CRC

Typical Performance Curves

Unless otherwise specified, VPUA=VPUB=13V, VDDI=5V, LVDD=AVDD=REF5
 Series products (BD3376MUV-M/BD3376EFV-C) use the same data.

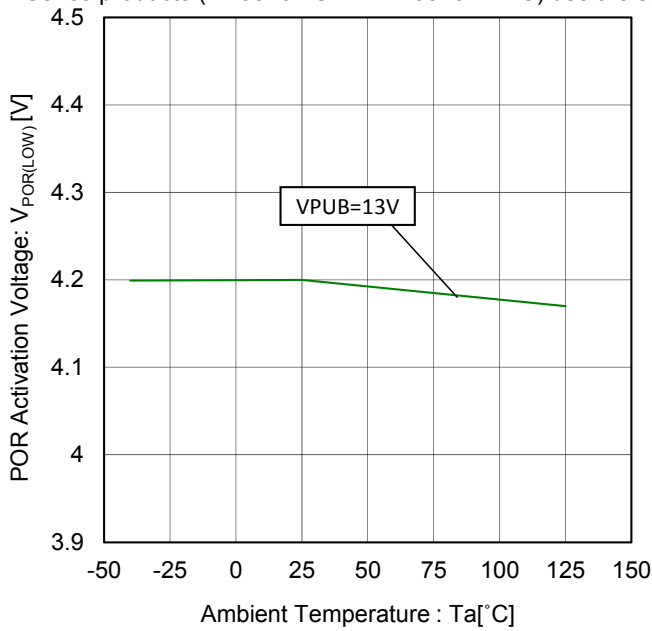

Figure 21. POR Activation Voltage vs Ambient Temperature

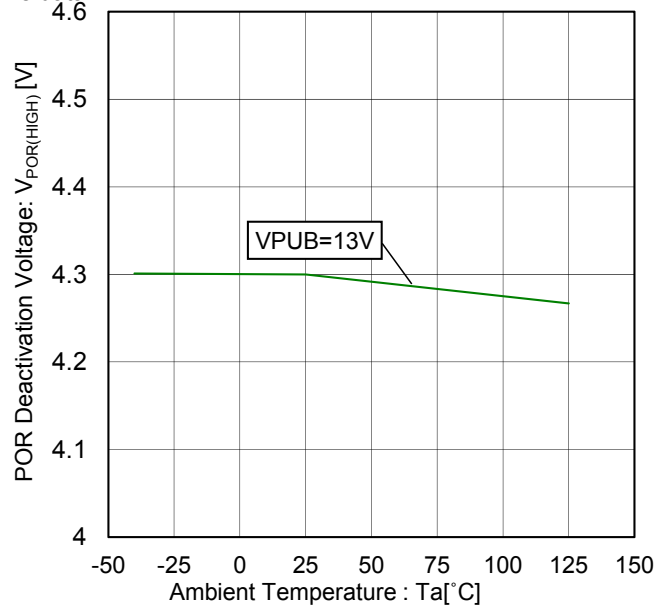

Figure 22. POR Deactivation Voltage vs Ambient Temperature

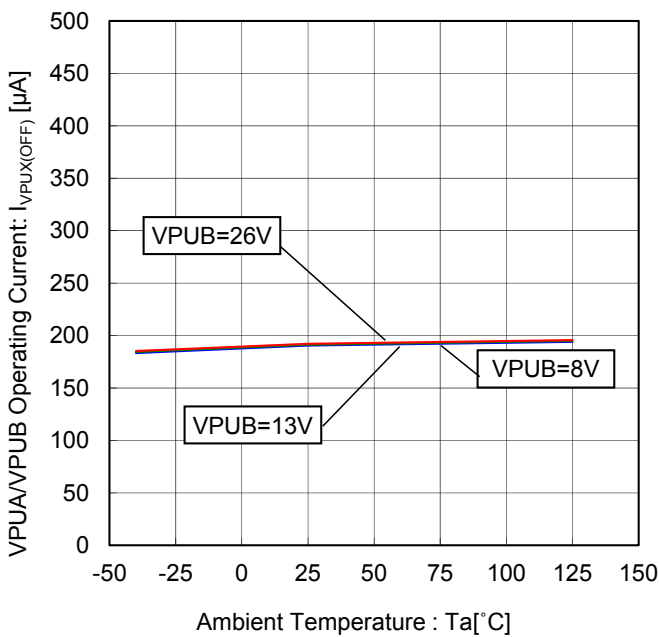

Figure 23. VPUA/VPUB Operating Current vs Ambient Temperature
 (Continuous monitor setting, Current source is invalid, "Hi-Z" Status)

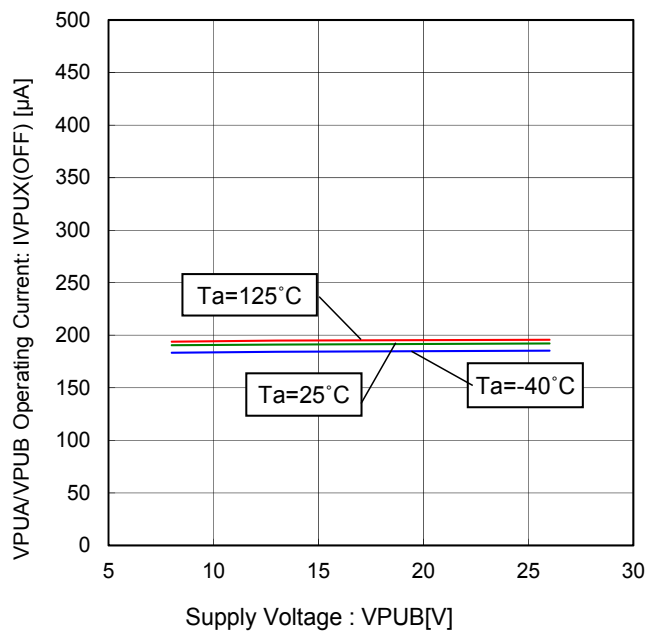

Figure 24. VPUA/VPUB Operating Current vs Supply Voltage
 (Continuous monitor setting, Current source is invalid, "Hi-Z" Status)

Typical Performance Curves - continued

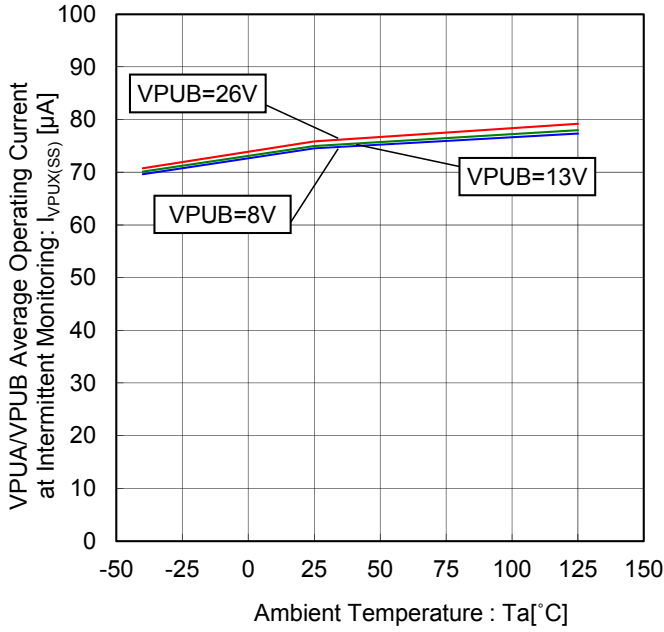

Figure 25. VPUA/VPUB Average Operating Current at Intermittent Monitoring vs Ambient Temperature (Monitoring Period: 50ms, Strobe Time: 125µs, Source/Sink Current Setting: 1mA)

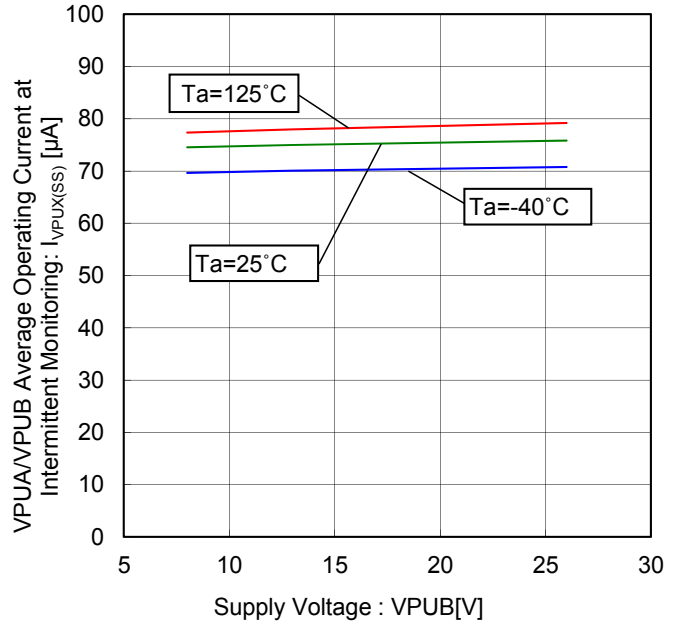

Figure 26. VPUA/VPUB Average Operating Current at Intermittent Monitoring vs Supply Voltage (Monitoring Period: 50ms, Strobe Time: 125µs, Source/Sink Current Setting: 1mA)

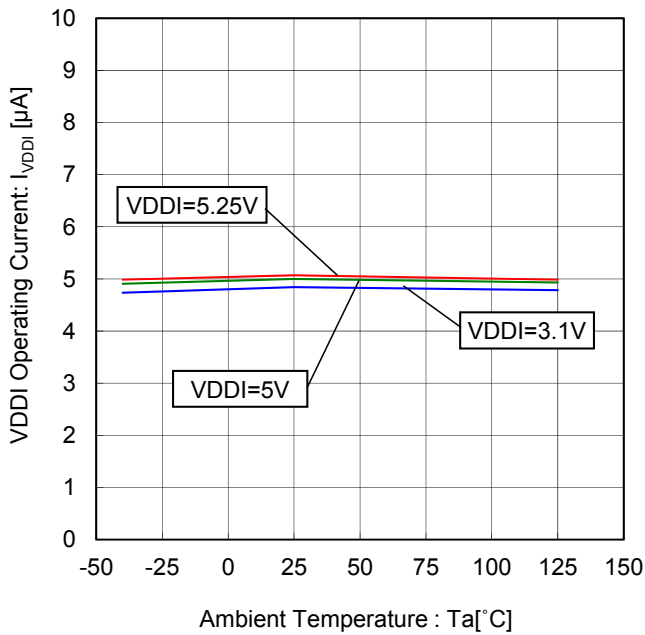

Figure 27. VDDI Operating Current vs Ambient Temperature (INTB="H", CSB="H")

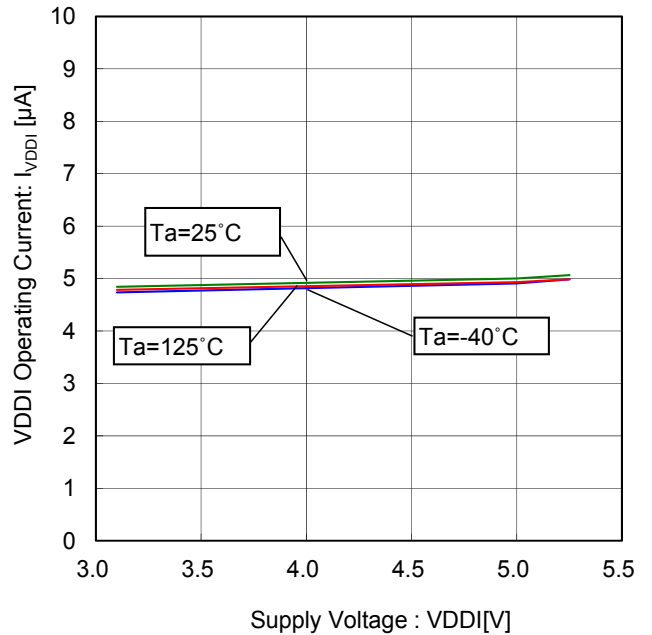

Figure 28. VDDI Operating Current vs Supply Voltage (INTB="H", CSB="H")

Typical Performance Curves - continued

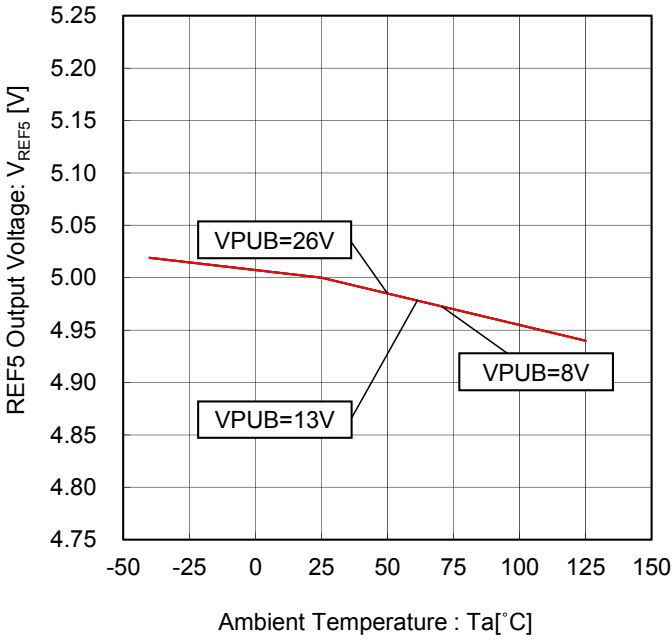

Figure 29. REF5 Output Voltage vs Ambient Temperature

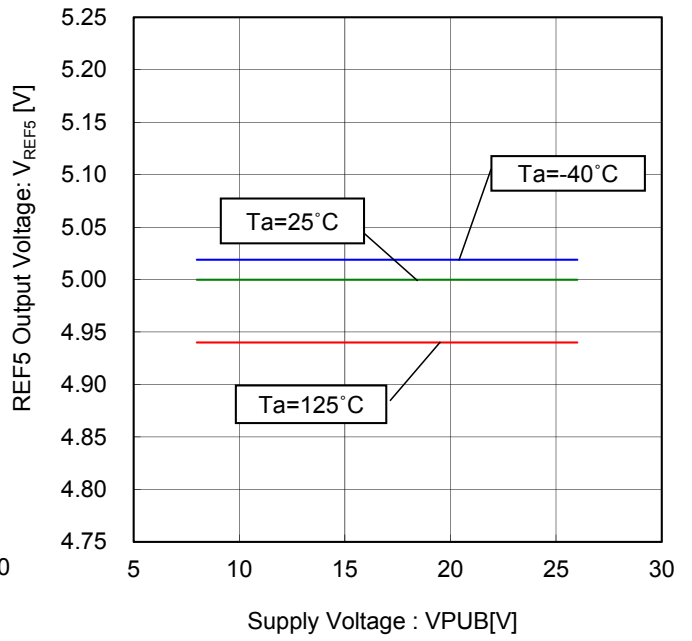

Figure 30. REF5 Output Voltage vs Supply Voltage

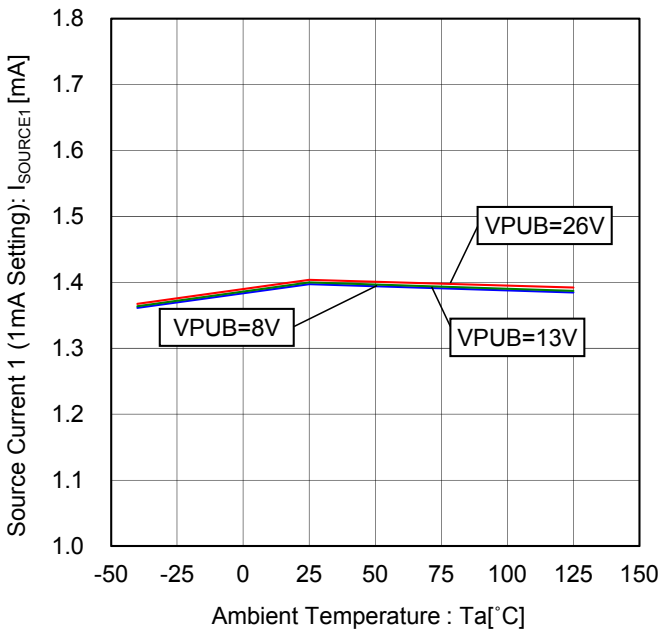

Figure 31. Source Current 1 (1mA Setting) vs Ambient Temperature (0V External Supply)

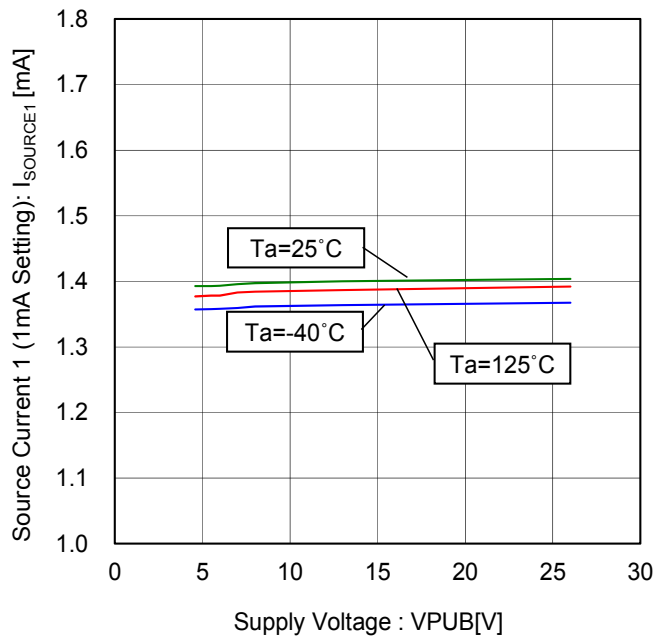

Figure 32. Source Current 1 (1mA Setting) vs Supply Voltage (0V External Supply)

Typical Performance Curves - continued

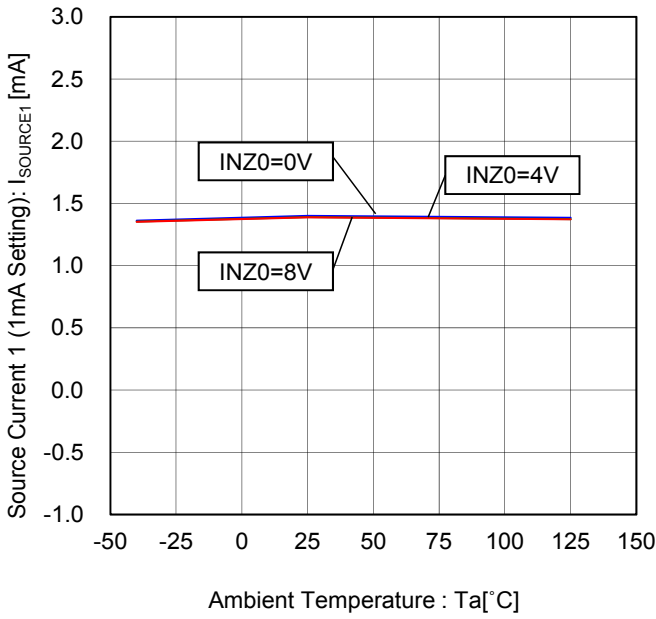

Figure 33. Source Current 1 (1mA Setting) vs Ambient Temperature

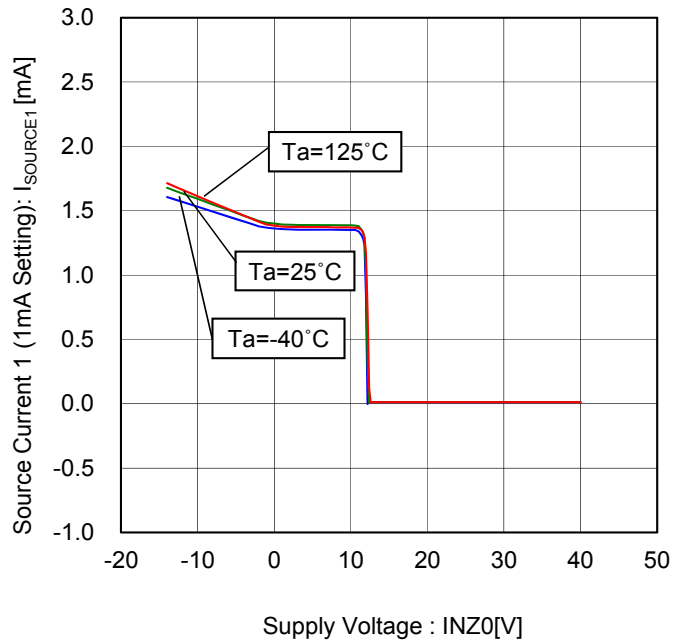

Figure 34. Source Current 1 (1mA Setting) vs Supply Voltage

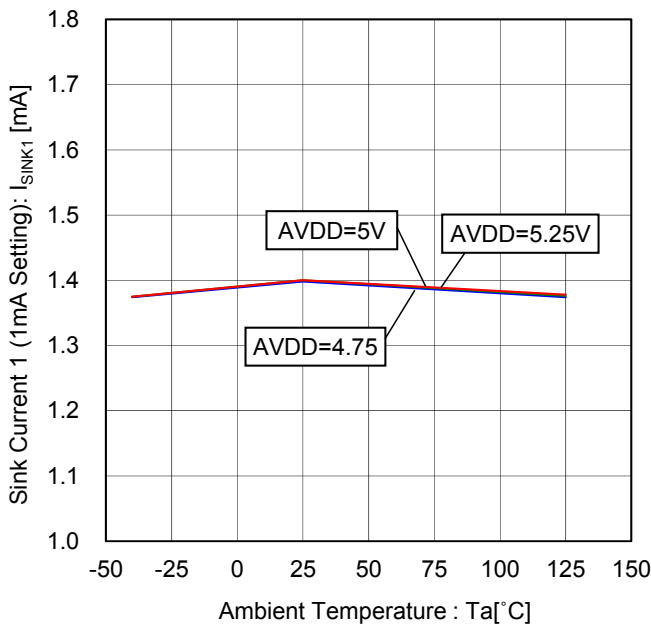

Figure 35. Sink Current 1 (1mA Setting) vs Ambient Temperature (8V External Supply)

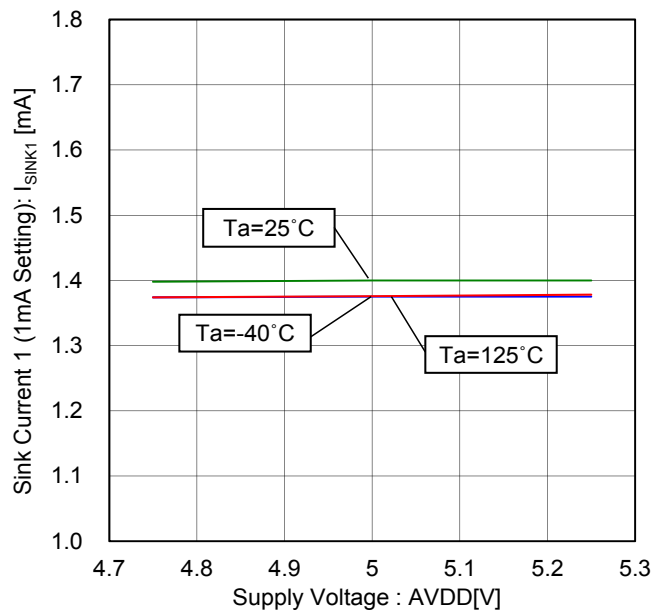

Figure 36. Sink Current 1 (1mA Setting) vs Supply Voltage (8V External Supply)

Typical Performance Curves - continued

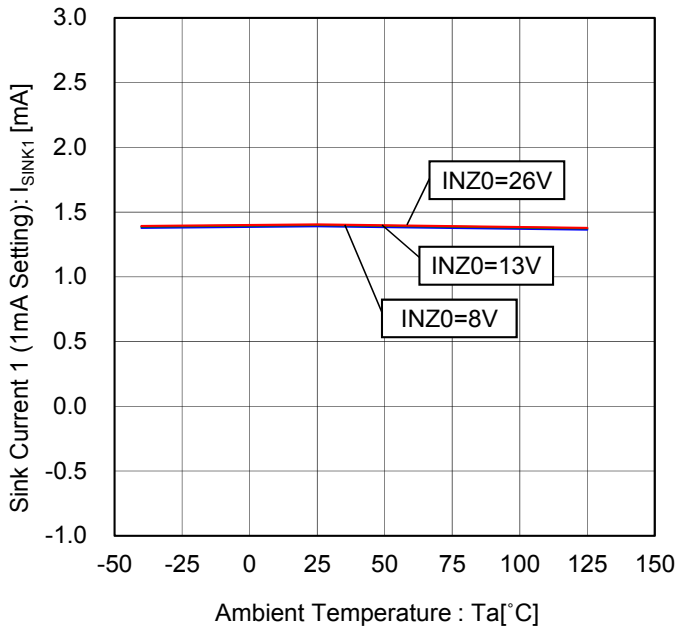

Figure 37. Sink Current 1 (1mA Setting) vs Ambient Temperature

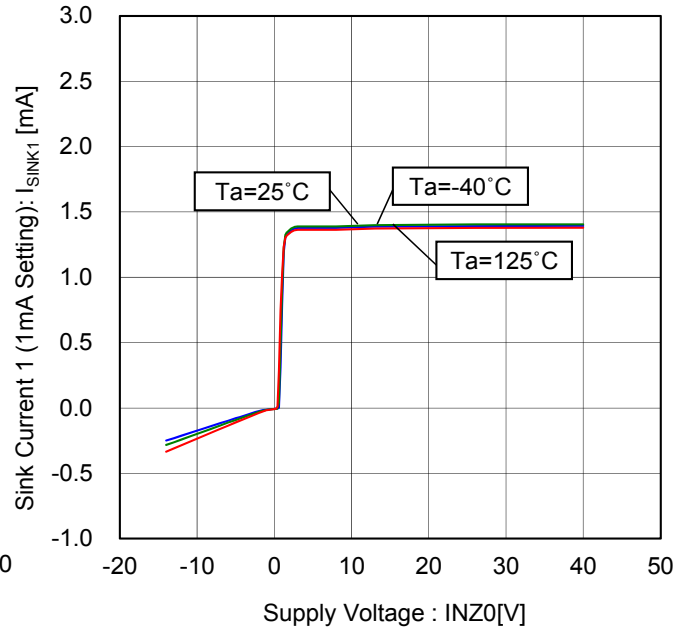

Figure 38. Sink Current 1 (1mA Setting) vs Supply Voltage

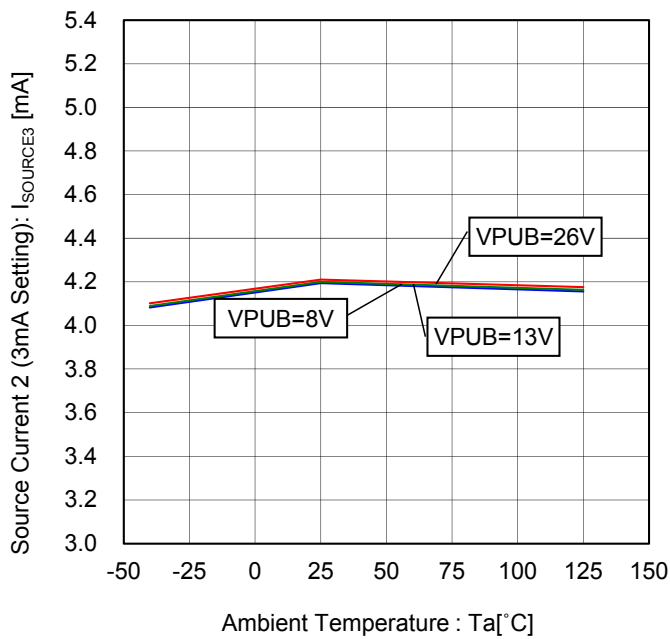

Figure 39. Source Current 2 (3mA Setting) vs Ambient Temperature (0V External Supply)

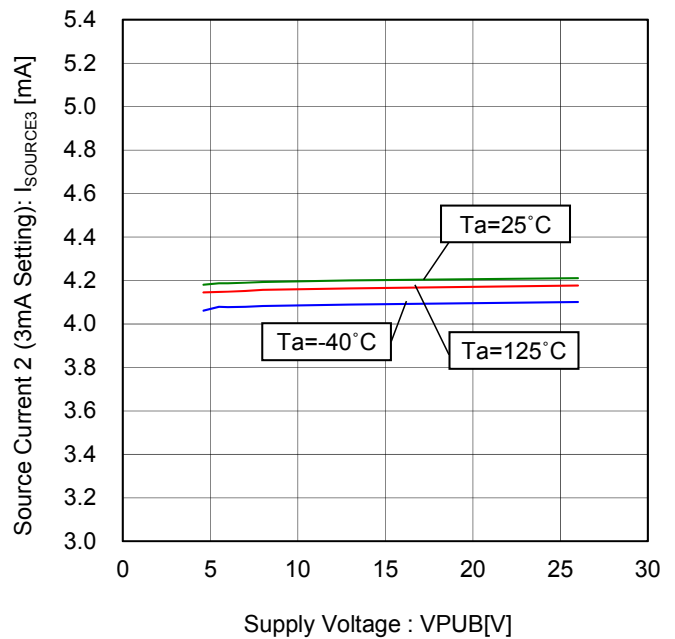

Figure 40. Source Current 2 (3mA Setting) vs Supply Voltage (0V External Supply)

Typical Performance Curves - continued

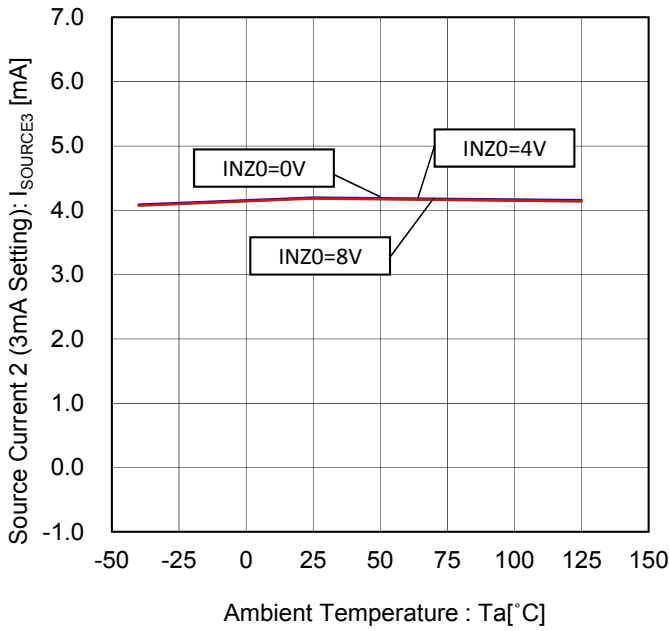

Figure 41. Source Current 2 (3mA Setting) vs Ambient Temperature

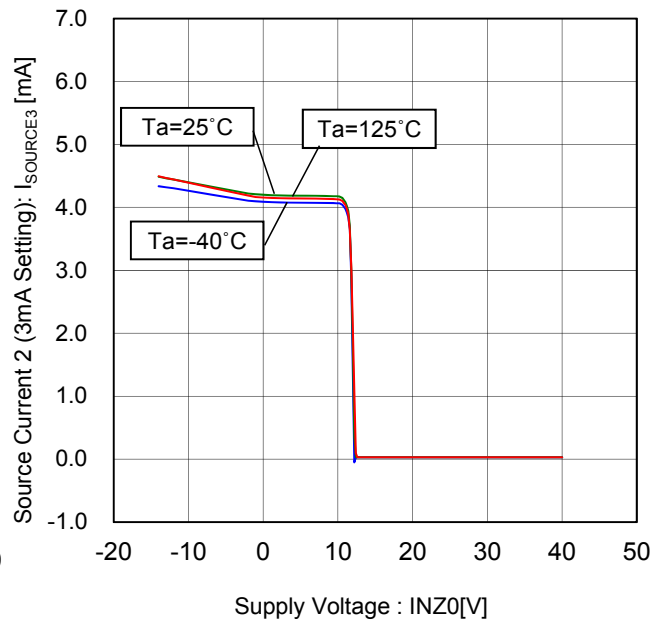

Figure 42. Source Current 2 (3mA Setting) vs Supply Voltage

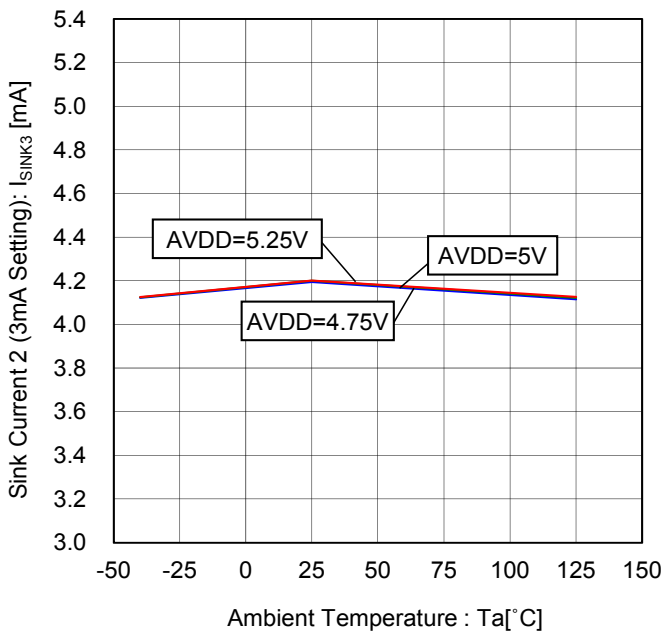

Figure 43. Sink Current 2 (3mA Setting) vs Ambient Temperature (8V External Supply)

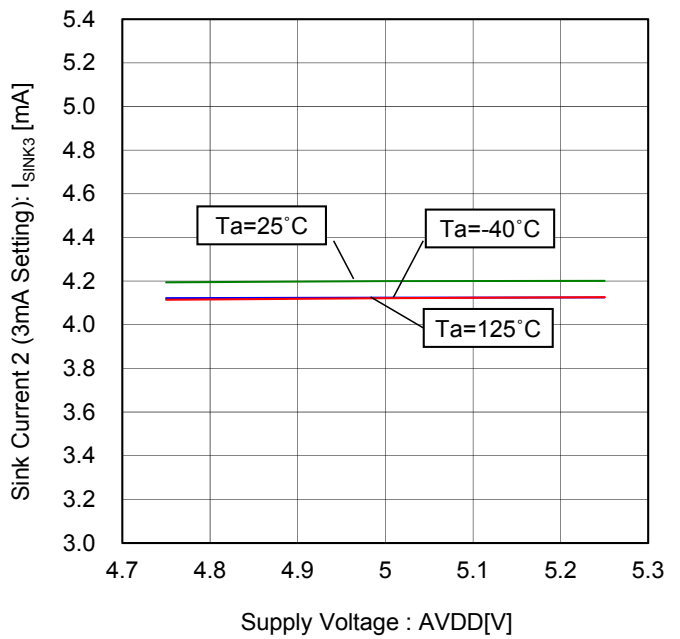

Figure 44. Sink Current 2 (3mA Setting) vs Supply Voltage (8V External Supply)

Typical Performance Curves - continued

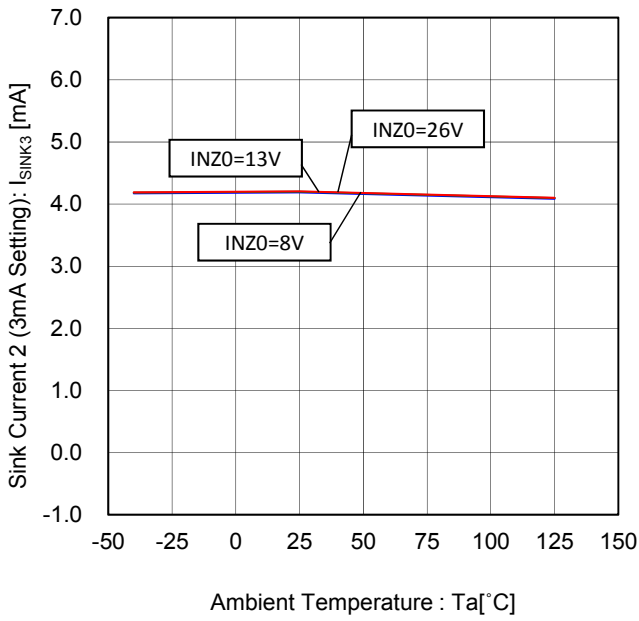

Figure 45. Sink Current 2 (3mA Setting) vs Ambient Temperature

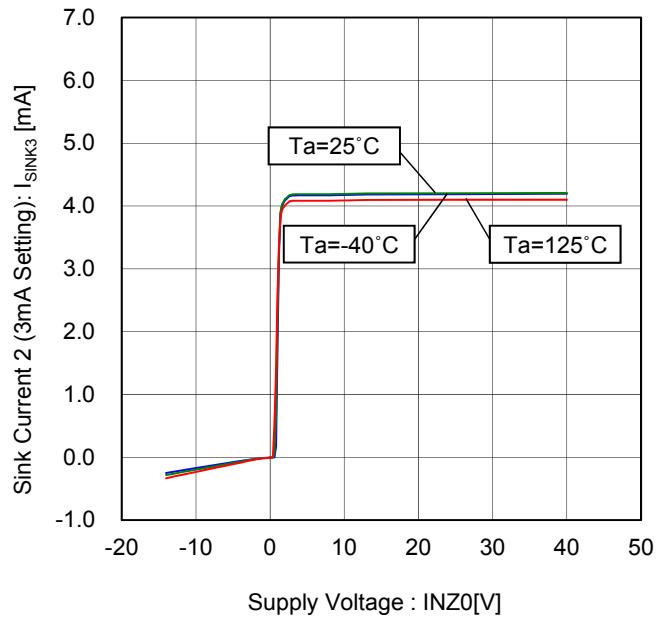

Figure 46. Sink Current 2 (3mA Setting) vs Supply Voltage

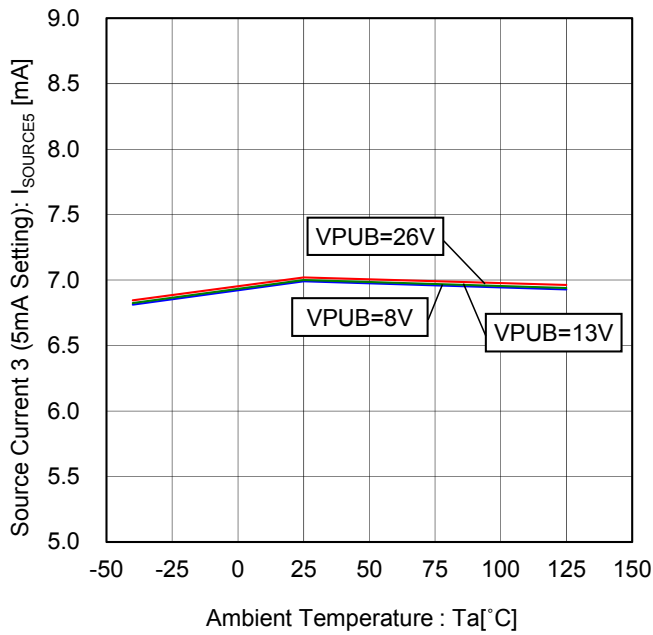

Figure 47. Source Current 3 (5mA Setting) vs Ambient Temperature (0V External Supply)

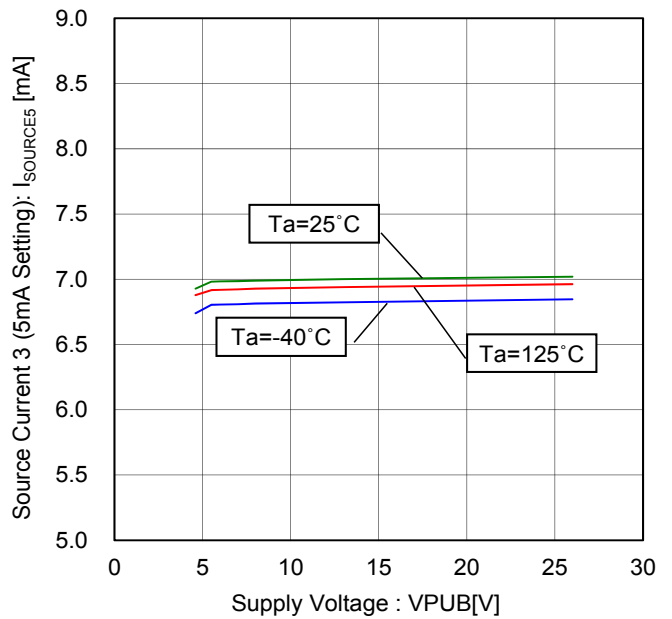

Figure 48. Source Current 3 (5mA Setting) vs Supply Voltage (0V External Supply)

Typical Performance Curves - continued

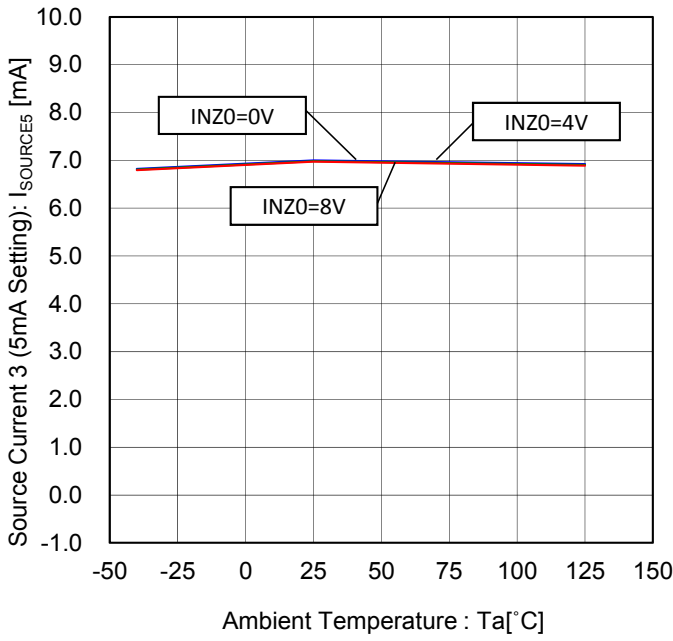

Figure 49. Source Current 3 (5mA Setting) vs Ambient Temperature

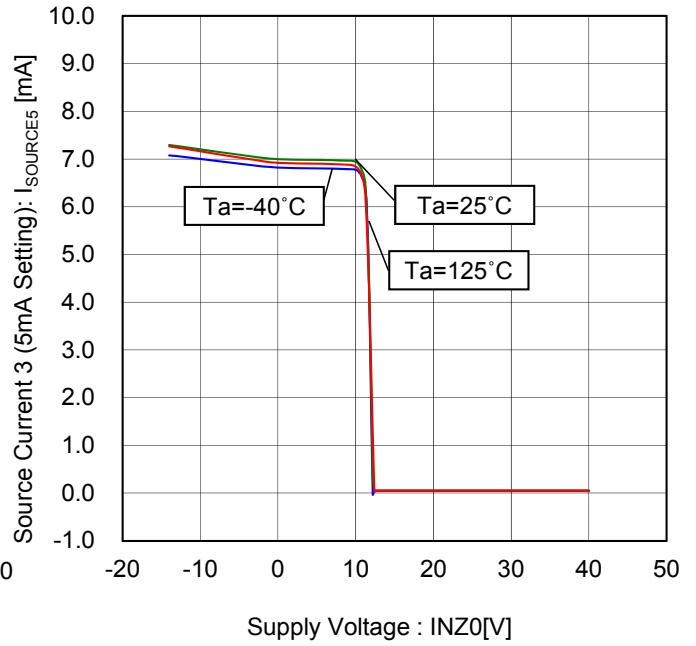

Figure 50. Source Current 3 (5mA Setting) vs Supply Voltage

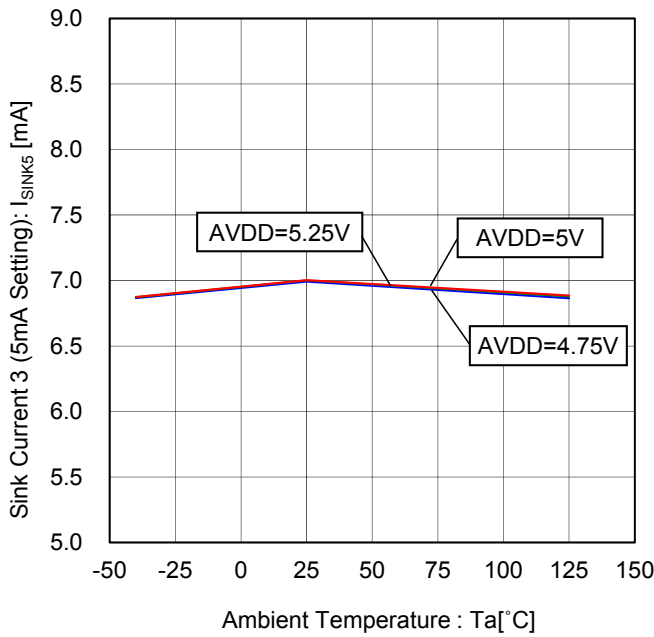

Figure 51. Sink Current 3 (5mA Setting) vs Ambient Temperature (8V External Supply)

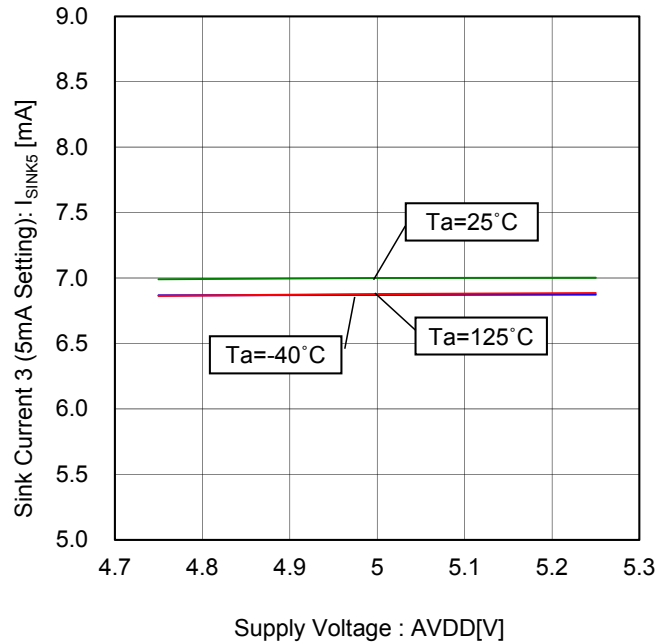

Figure 52. Sink Current 3 (5mA Setting) vs Supply Voltage (8V External Supply)

Typical Performance Curves - continued

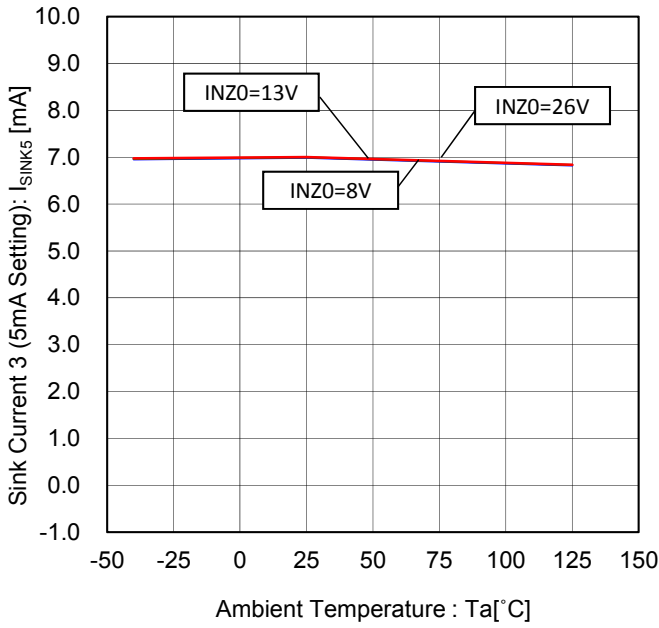

Figure 53. Sink Current 3 (5mA Setting) vs Ambient Temperature

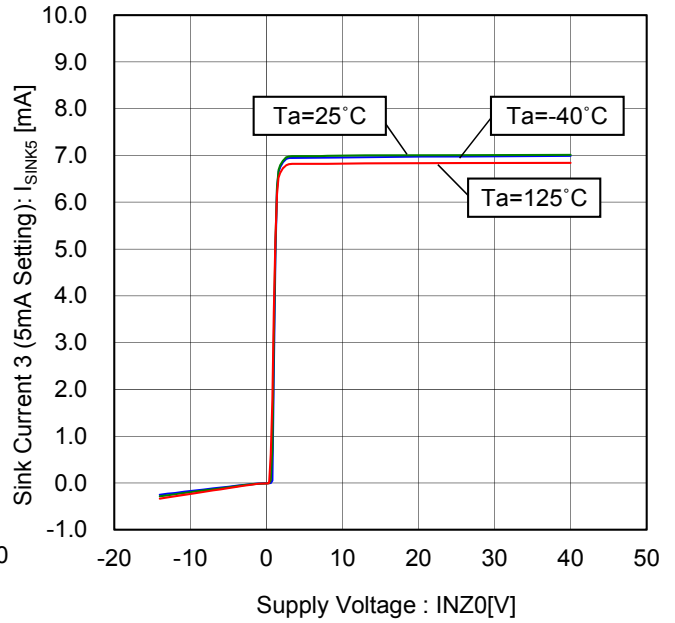

Figure 54. Sink Current 3 (5mA Setting) vs Supply Voltage

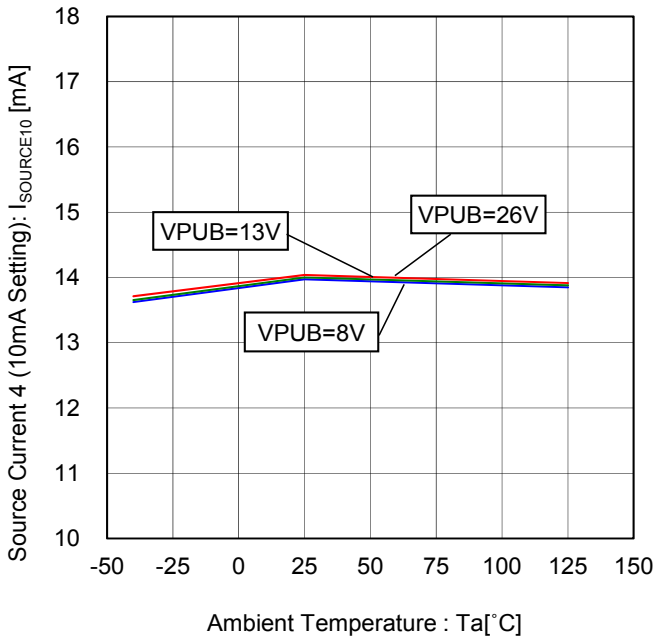

Figure 55. Source Current 4 (10mA Setting) vs Ambient Temperature (0V External Supply)

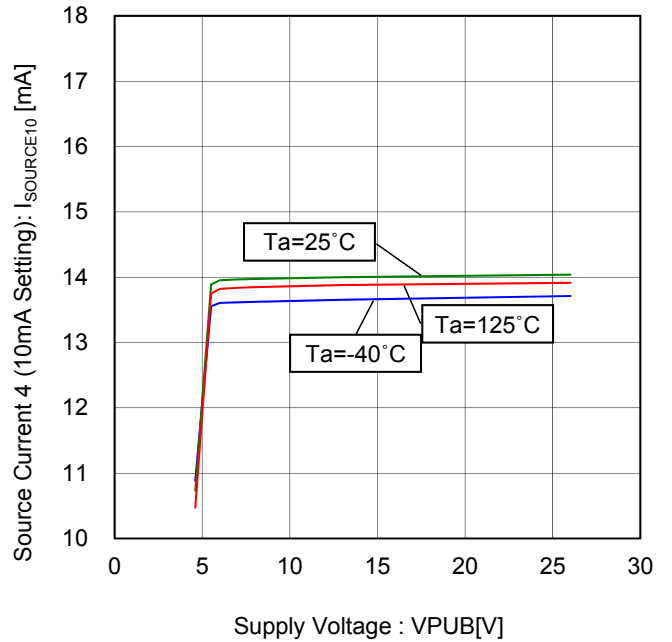

Figure 56. Source Current 4 (10mA Setting) vs Supply Voltage (0V External Supply)

Typical Performance Curves - continued

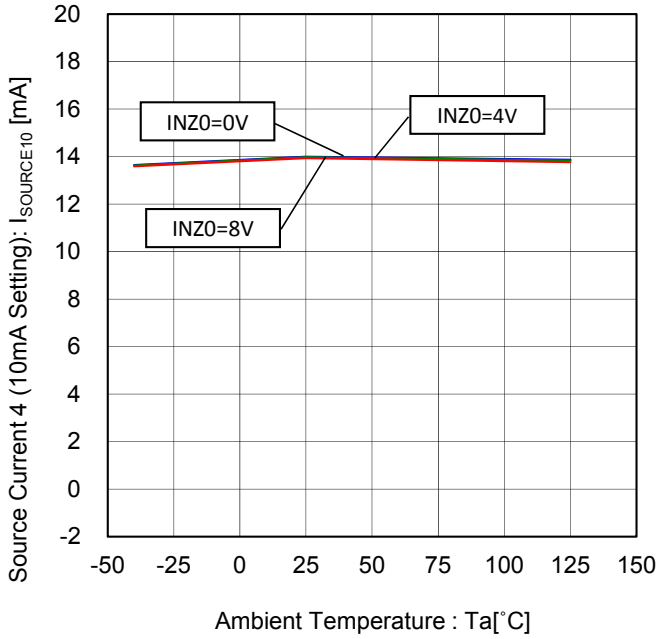

Figure 57. Source Current 4 (10mA Setting) vs Ambient Temperature

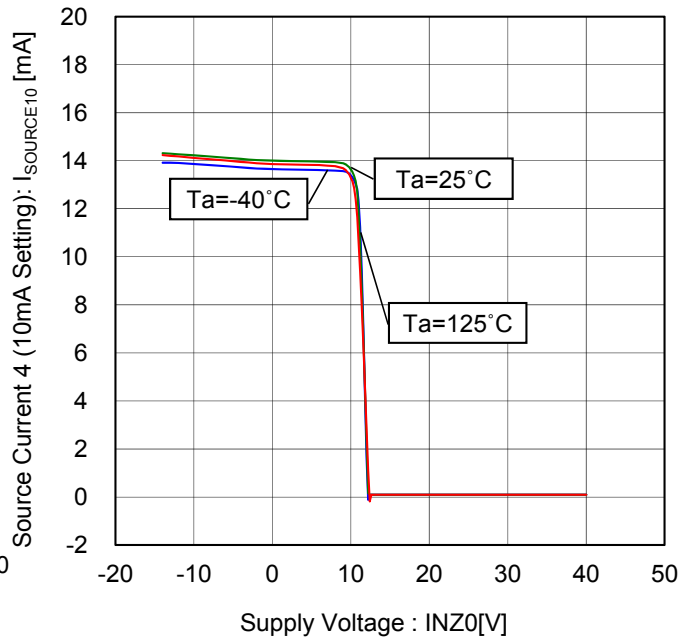

Figure 58. Source Current 4 (10mA Setting) vs Supply Voltage

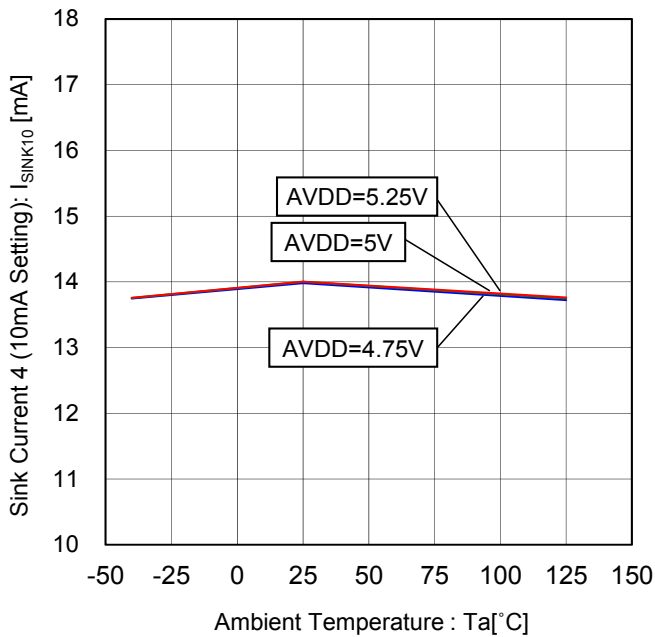

Figure 59. Sink Current 4 (10mA Setting) vs Ambient Temperature (8V External Supply)

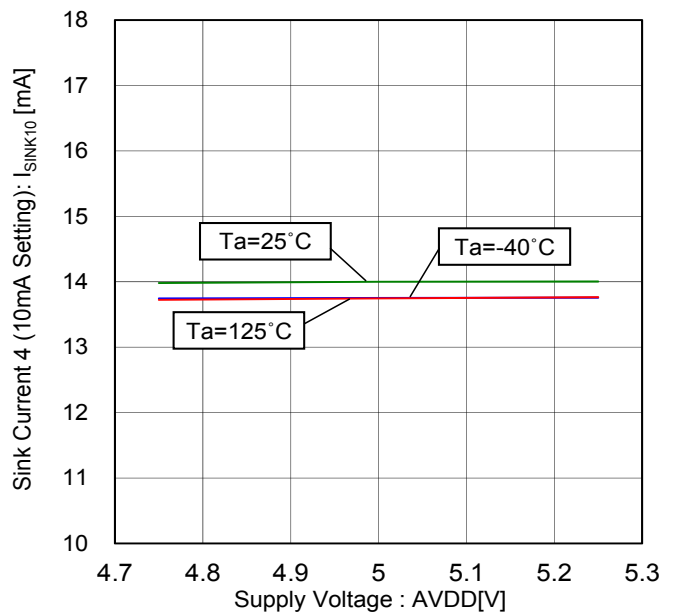

Figure 60. Sink Current 4 (10mA Setting) vs Supply Voltage (8V External Supply)

Typical Performance Curves - continued

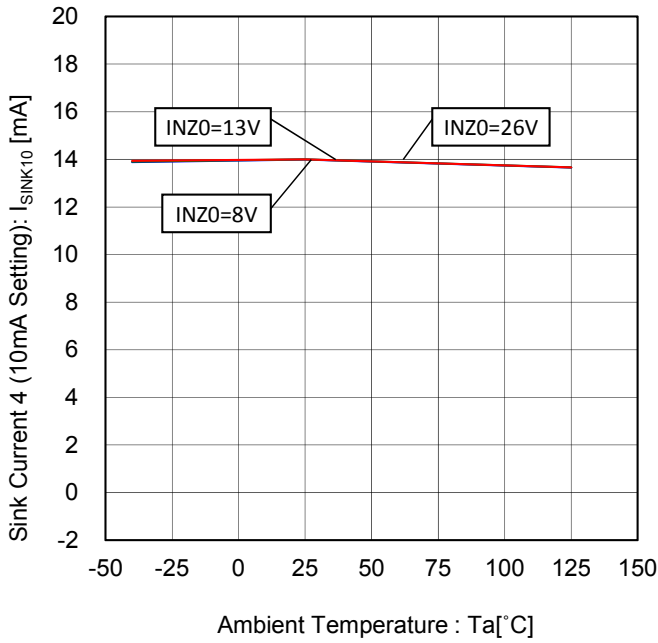

Figure 61. Sink Current 4 (10mA Setting) vs Ambient Temperature

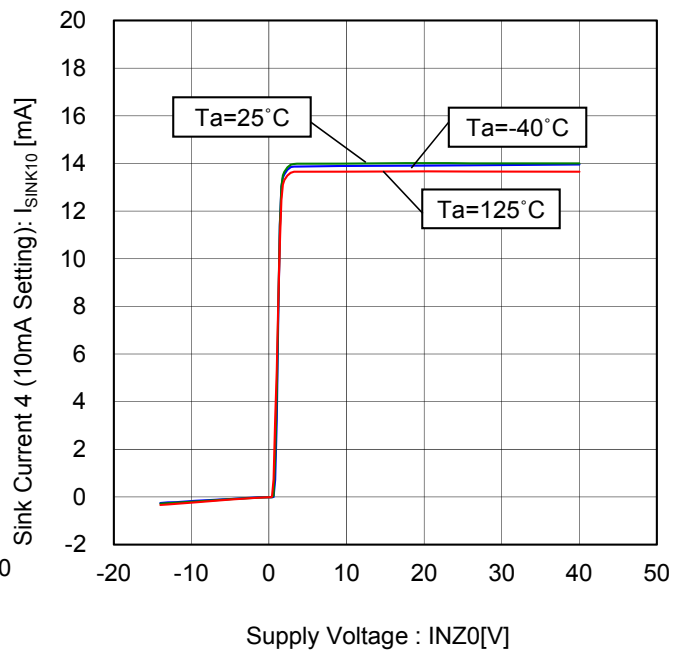

Figure 62. Sink Current 4 (10mA Setting) vs Supply Voltage

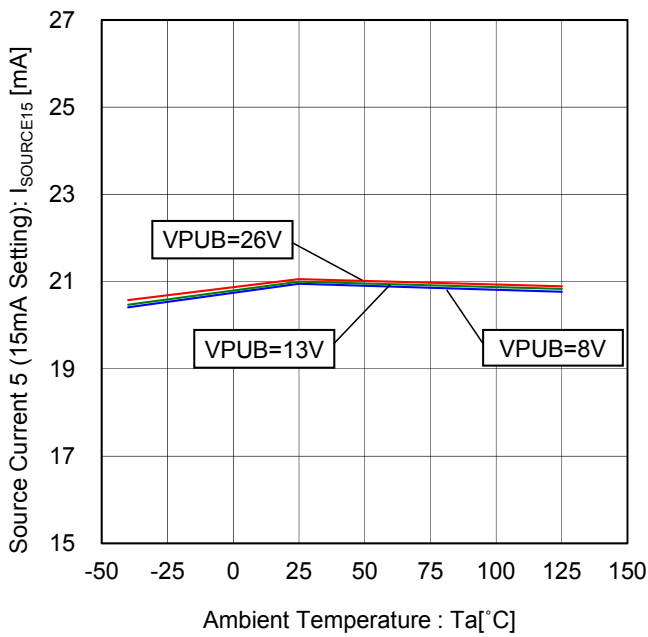

Figure 63. Source Current 5 (15mA Setting) vs Ambient Temperature (0V External Supply)

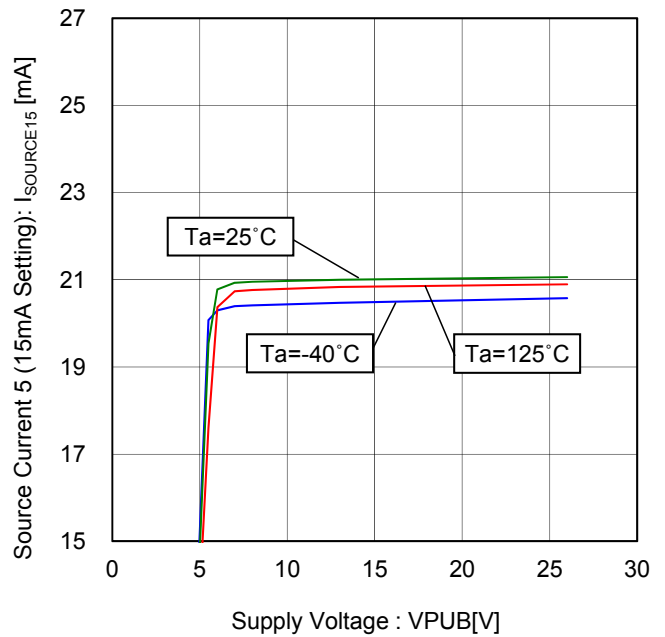

Figure 64. Source Current 5 (15mA Setting) vs Supply Voltage (0V External Supply)

Typical Performance Curves - continued

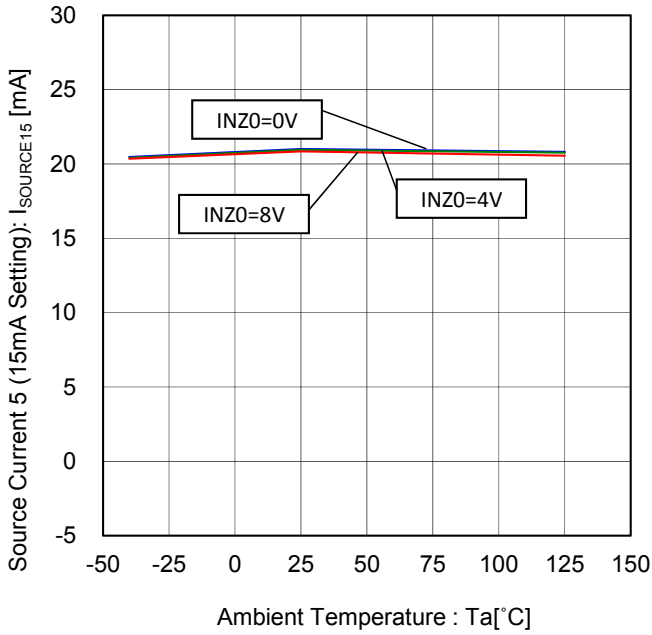

Figure 65. Source Current 5 (15mA Setting) vs Ambient Temperature

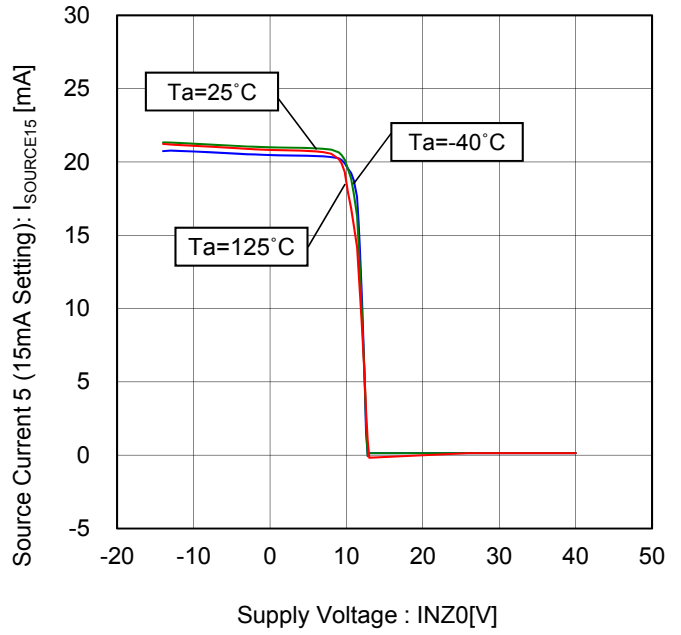

Figure 66. Source Current 5 (15mA Setting) vs Supply Voltage

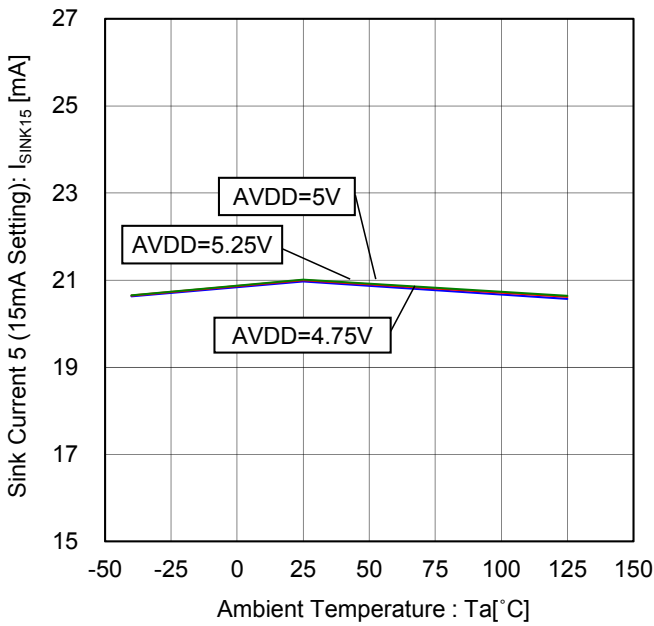

Figure 67. Sink Current 5 (15mA Setting) vs Ambient Temperature (8V External Supply)

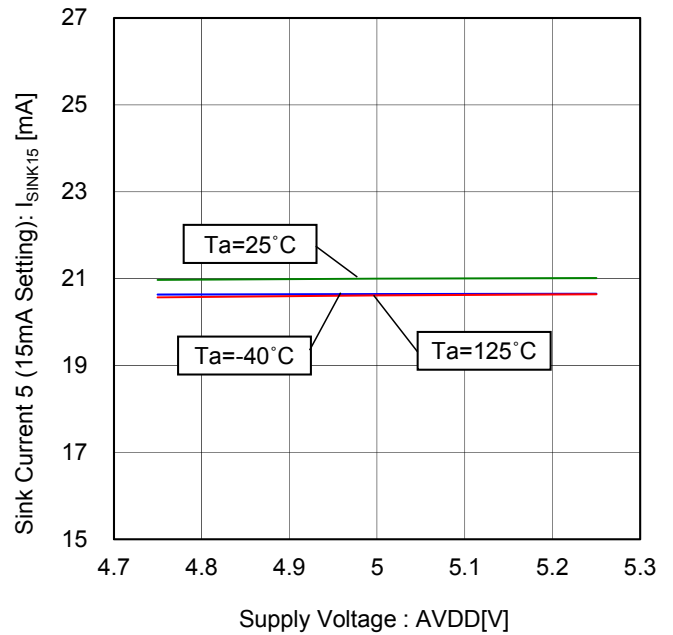

Figure 68. Sink Current 5 (15mA Setting) vs Supply Voltage (8V External Supply)

Typical Performance Curves - continued

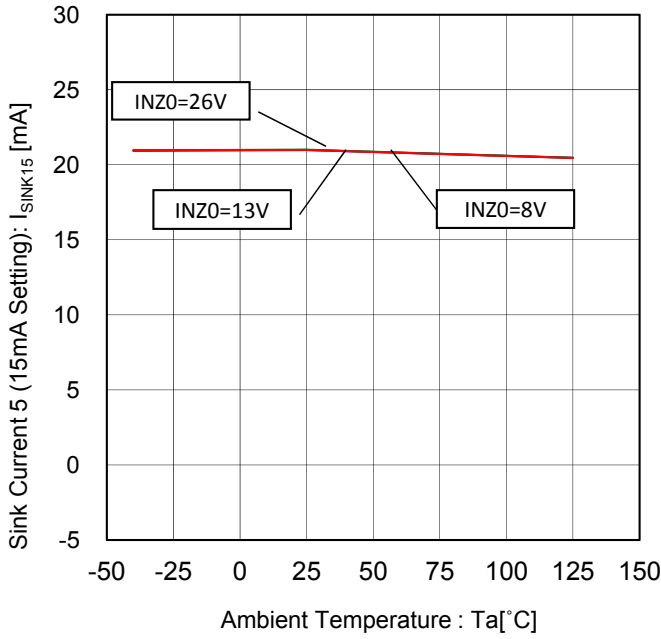

Figure 69. Sink Current 5 (15mA Setting) vs Ambient Temperature

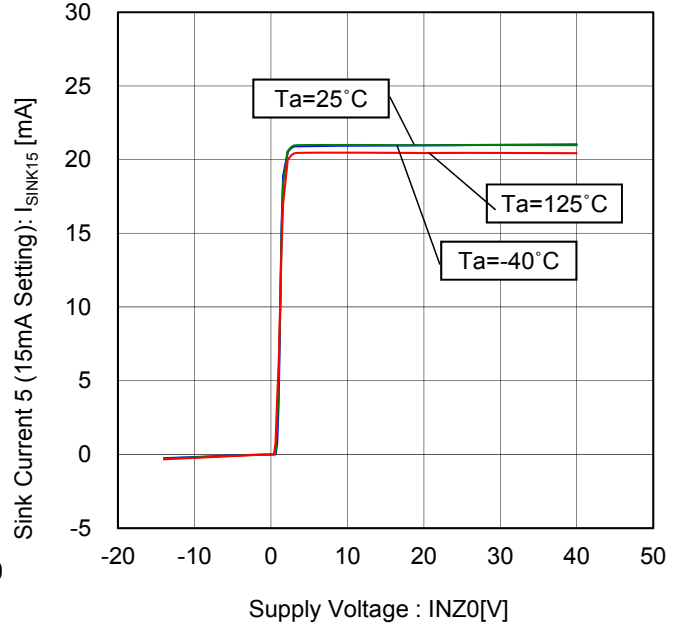

Figure 70. Sink Current 5 (15mA Setting) vs Supply Voltage

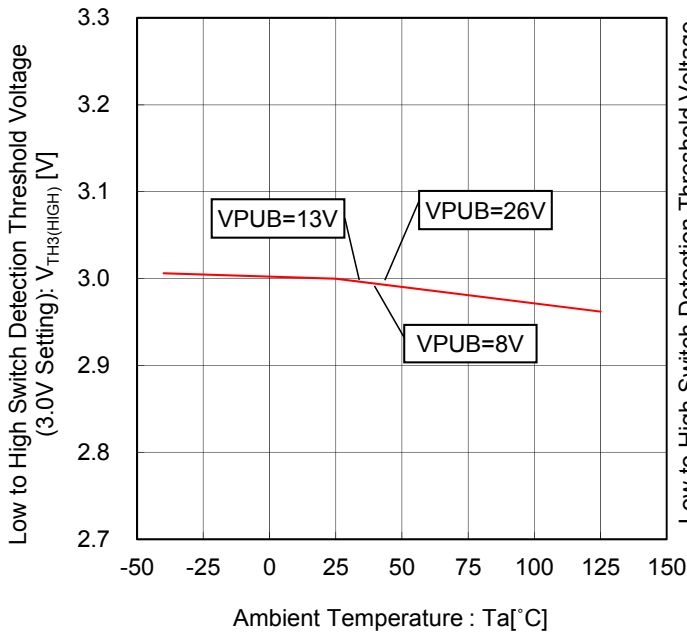

Figure 71. Low to High Switch Detection Threshold Voltage (3.0V Setting) vs Ambient Temperature

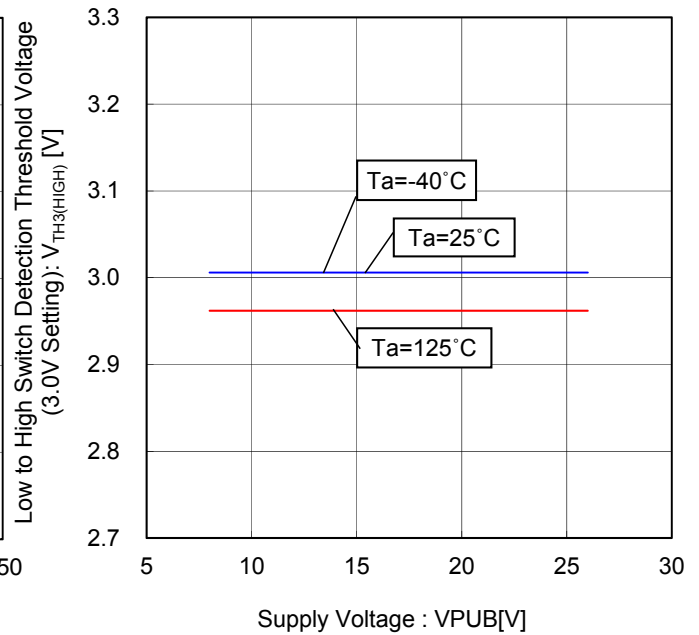

Figure 72. Low to High Switch Detection Threshold Voltage (3.0V Setting) vs Supply Voltage

Typical Performance Curves - continued

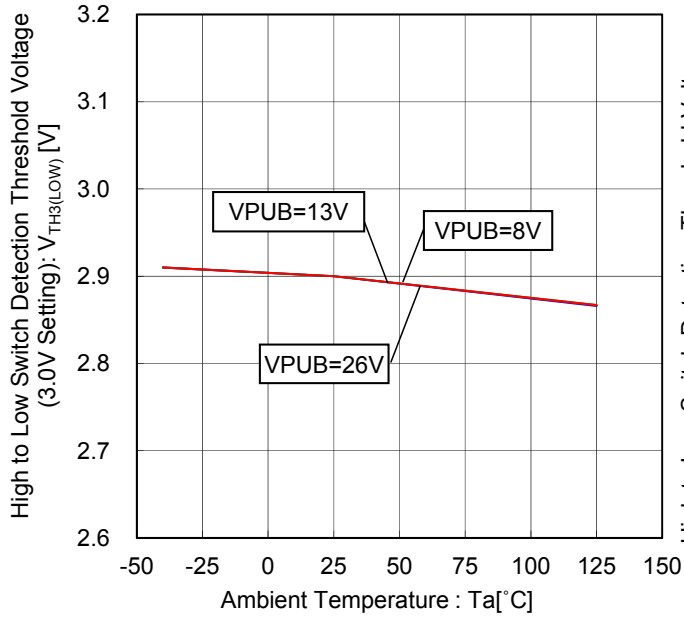

Figure 73. High to Low Switch Detection Threshold Voltage (3.0V Setting) vs Ambient Temperature

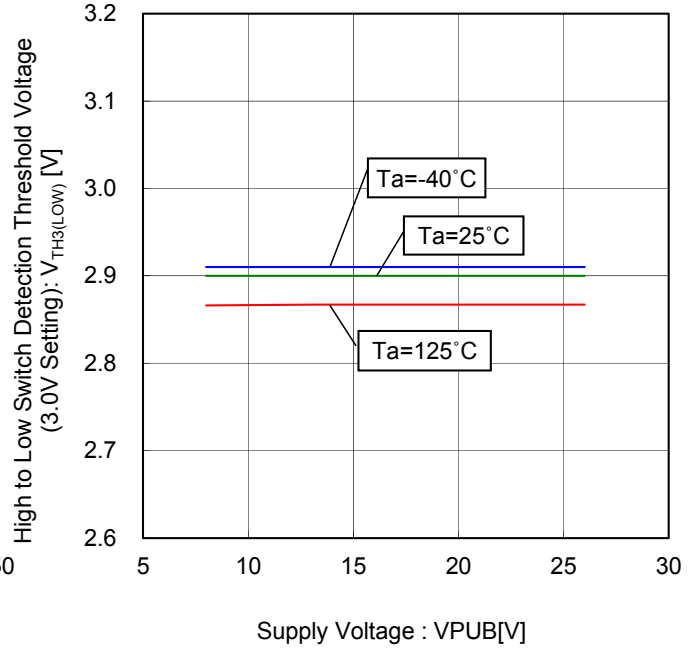

Figure 74. High to Low Switch Detection Threshold Voltage (3.0V Setting) vs Supply Voltage

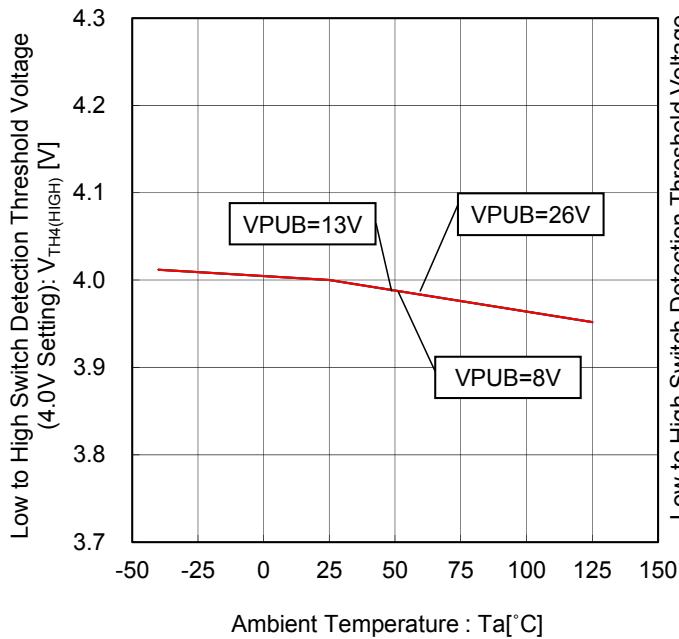

Figure 75. Low to High Switch Detection Threshold Voltage (4.0V Setting) vs Ambient Temperature

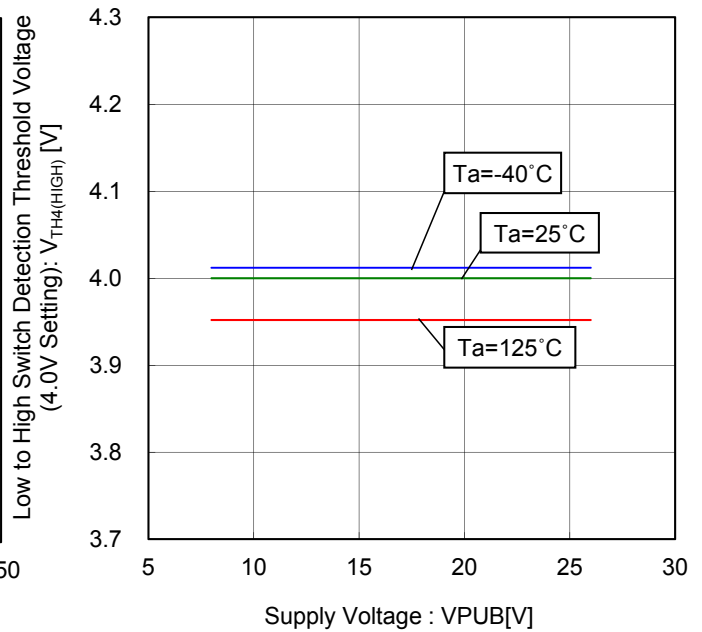

Figure 76. Low to High Switch Detection Threshold Voltage (4.0V Setting) vs Supply Voltage

Typical Performance Curves - continued

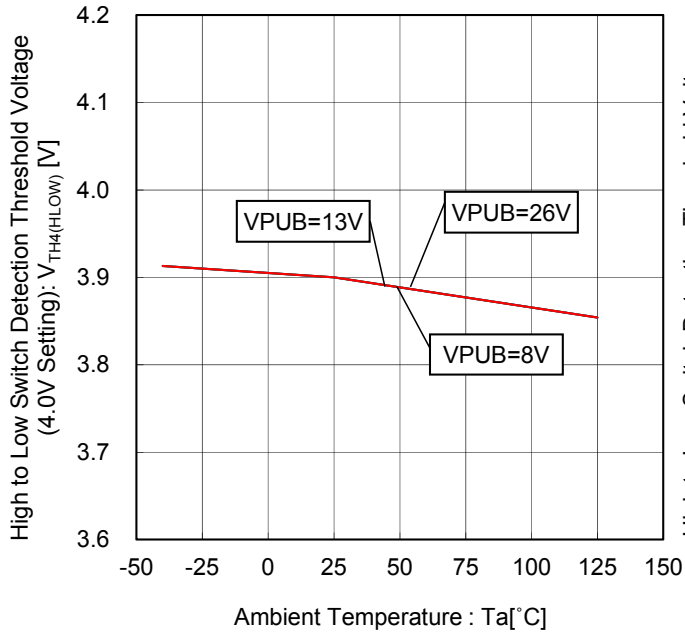

Figure 77. High to Low Switch Detection Threshold Voltage (4.0V Setting) vs Ambient Temperature

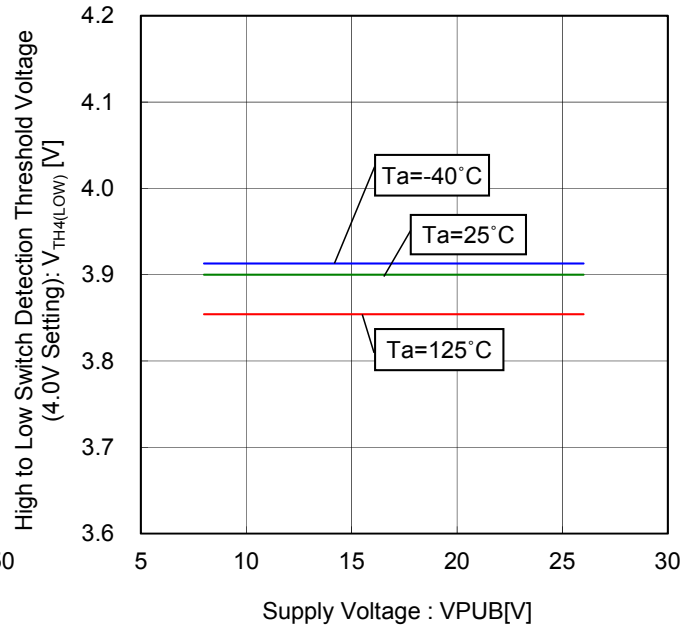

Figure 78. High to Low Switch Detection Threshold Voltage (4.0V Setting) vs Supply Voltage

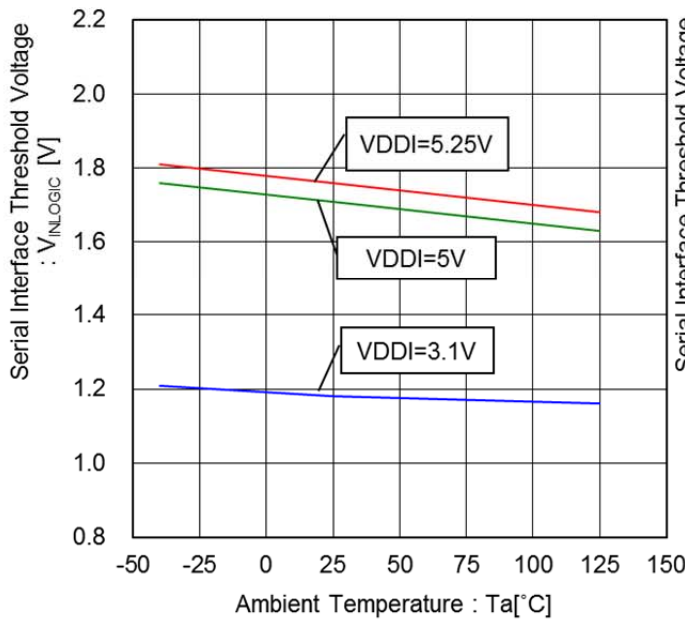

Figure 79. Serial Interface Threshold Voltage vs Ambient Temperature

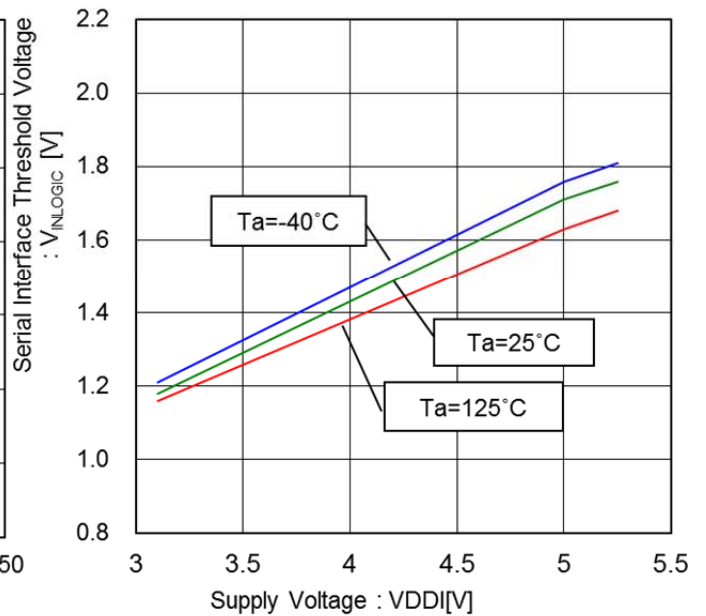

Figure 80. Serial Interface Threshold Voltage vs Supply Voltage

Typical Performance Curves - continued

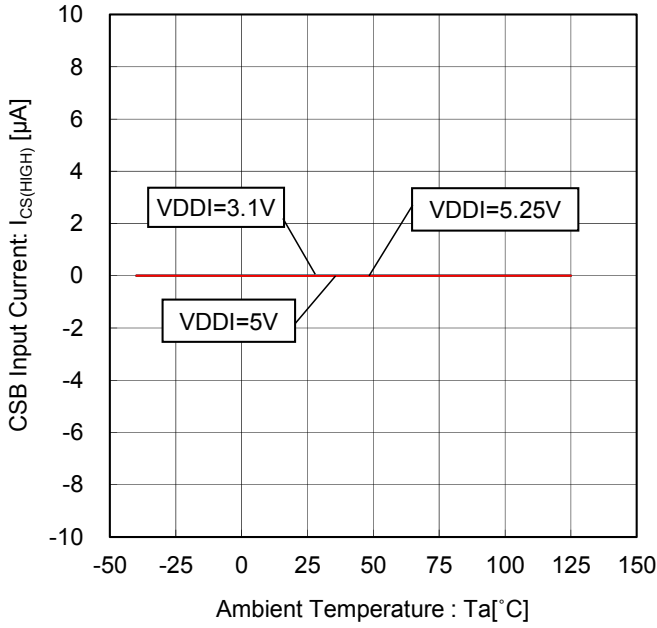

Figure 81. CSB Input Current vs Ambient Temperature (CSB=VDDI)

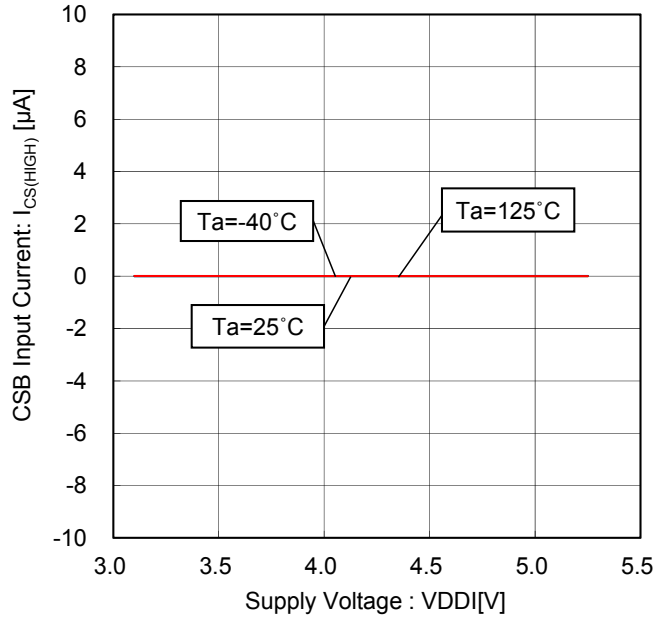

Figure 82. CSB Input Current vs Supply Voltage (CSB=VDDI)

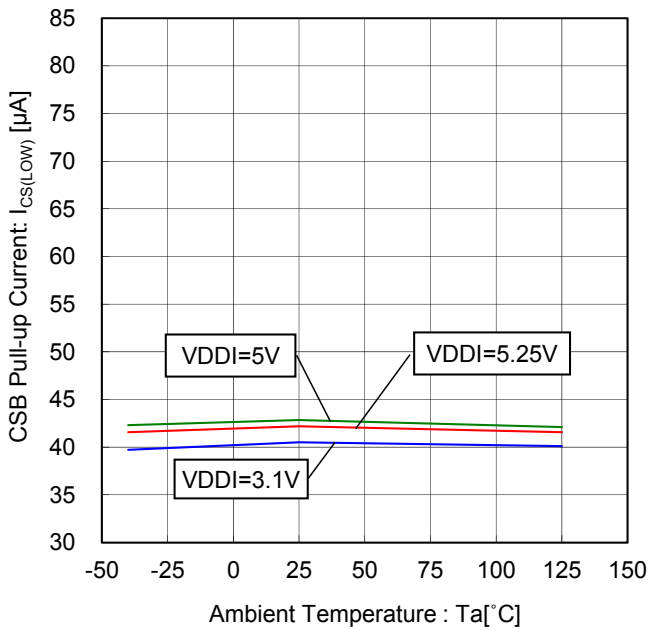

Figure 83. CSB Pull-up Current vs Ambient Temperature (CSB=0V)

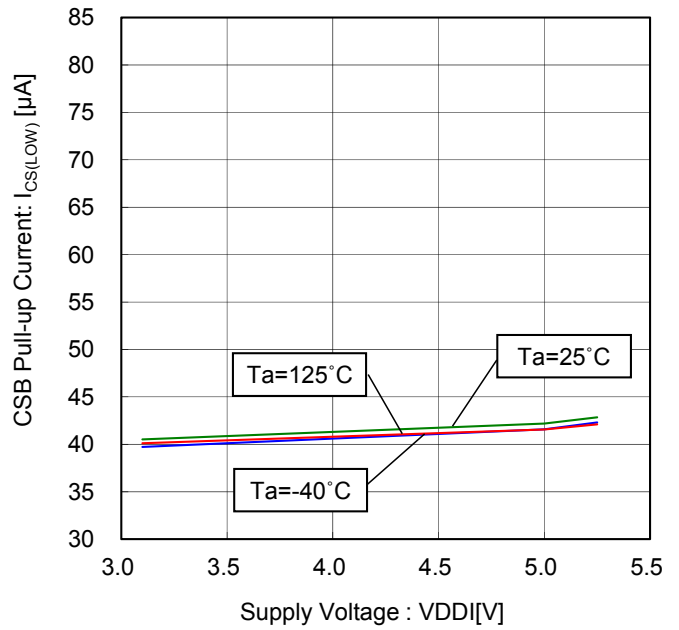

Figure 84. CSB Pull-up Current vs Supply Voltage (CSB=0V)

Typical Performance Curves - continued

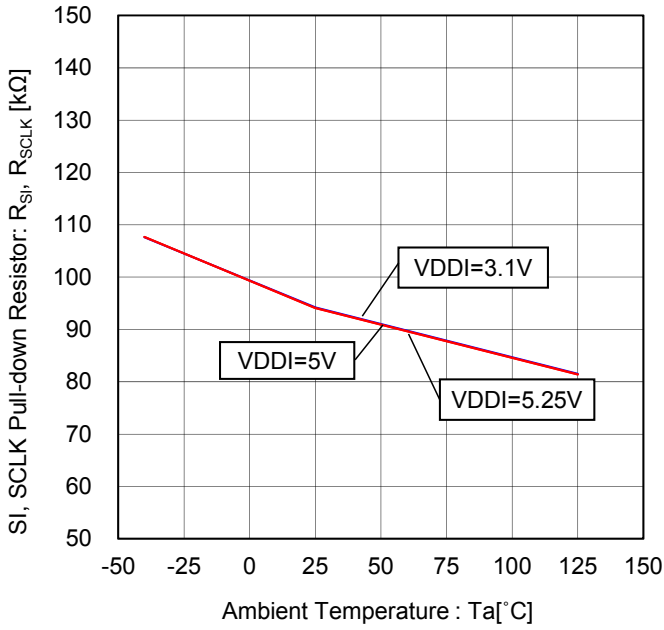

Figure 85. SI, SCLK Pull-down Resistor vs Ambient Temperature

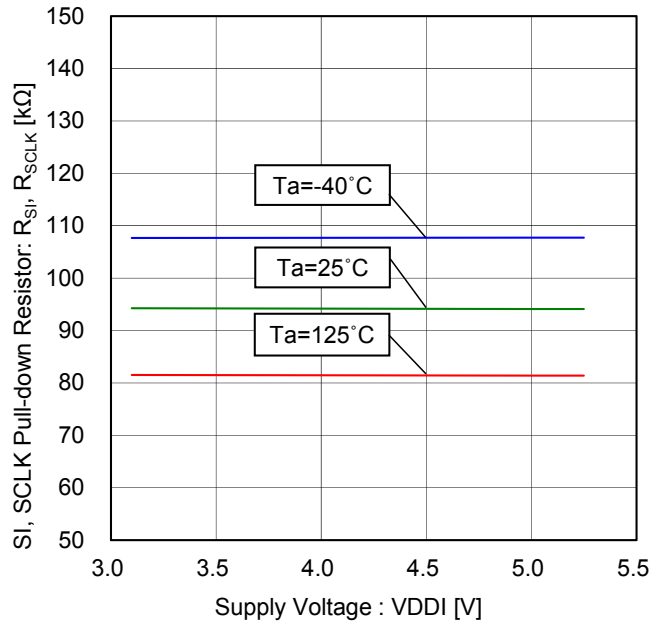

Figure 86. SI, SCLK Pull-down Resistor vs Supply Voltage

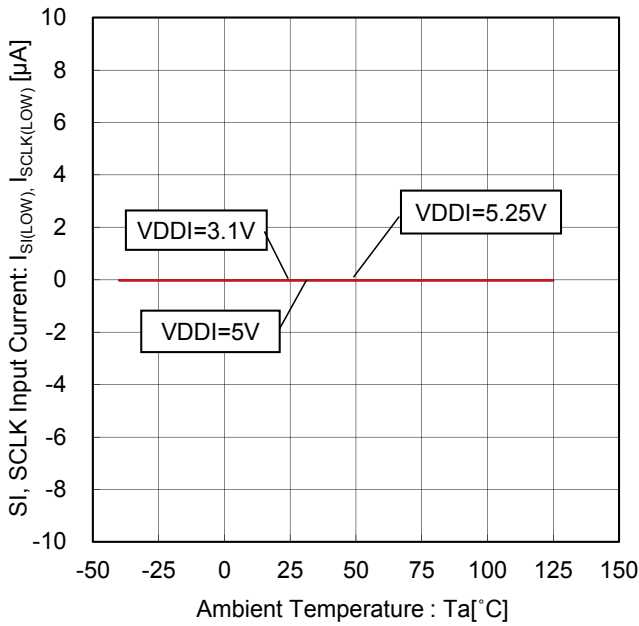

Figure 87. SI, SCLK Input Current vs Ambient Temperature (SI, SCLK=0V)

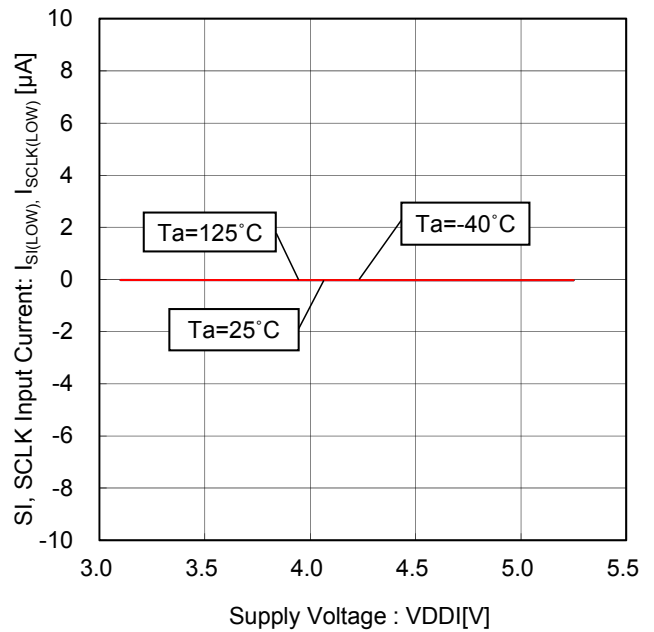

Figure 88. SI, SCLK Input Current vs Supply Voltage (SI, SCLK=0V)

Typical Performance Curves - continued

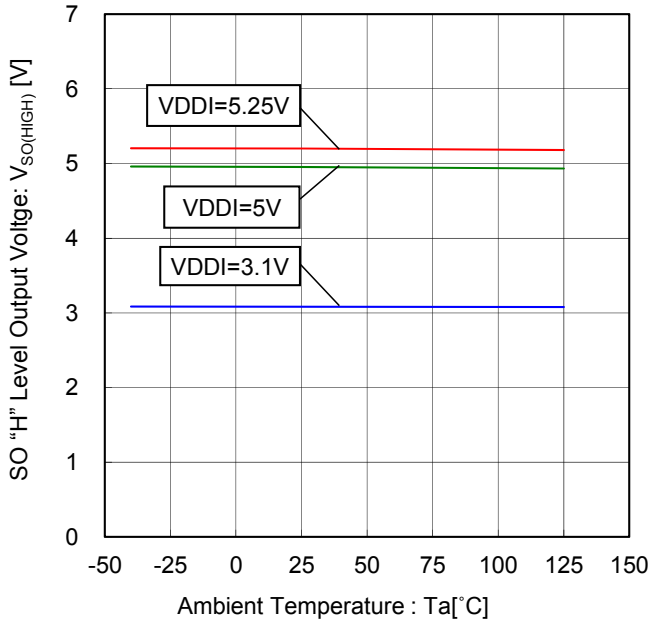

Figure 89. SO "H" Level Output Voltage vs Ambient Temperature (I_{SOURCE}=200μA)

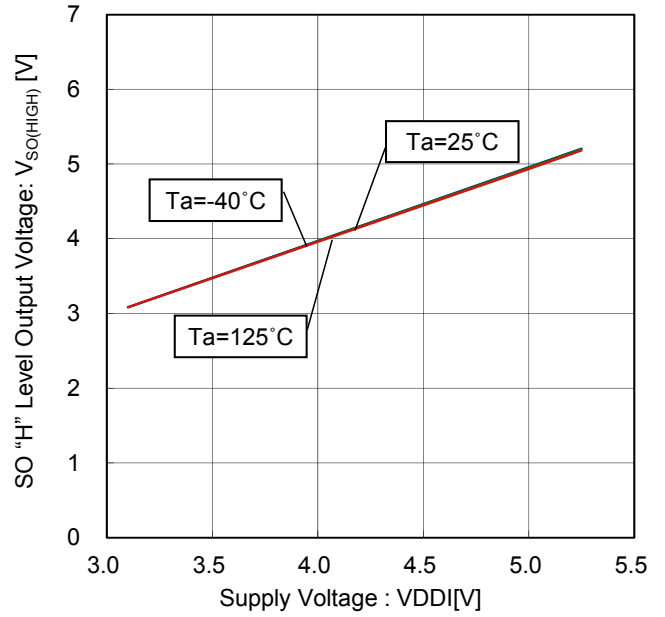

Figure 90. SO "H" Level Output Voltage vs Supply Voltage (I_{SOURCE}=200μA)

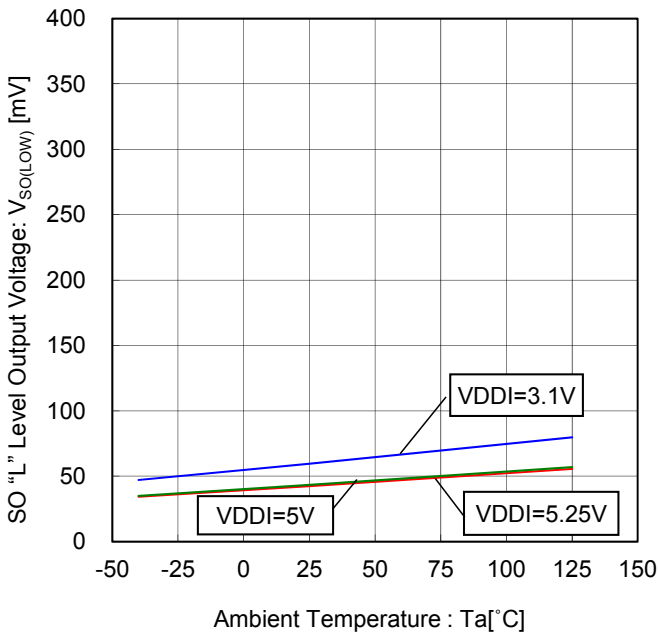

Figure 91. SO "L" Level Output Voltage vs Ambient Temperature (I_{SINK}=1.6mA)

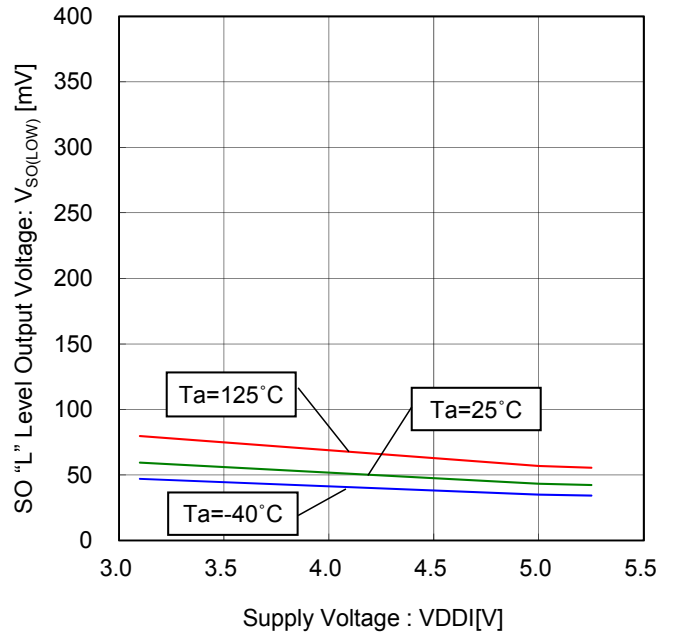

Figure 92. SO "L" Level Output Voltage vs Supply Voltage (I_{SINK}=1.6mA)

Typical Performance Curves - continued

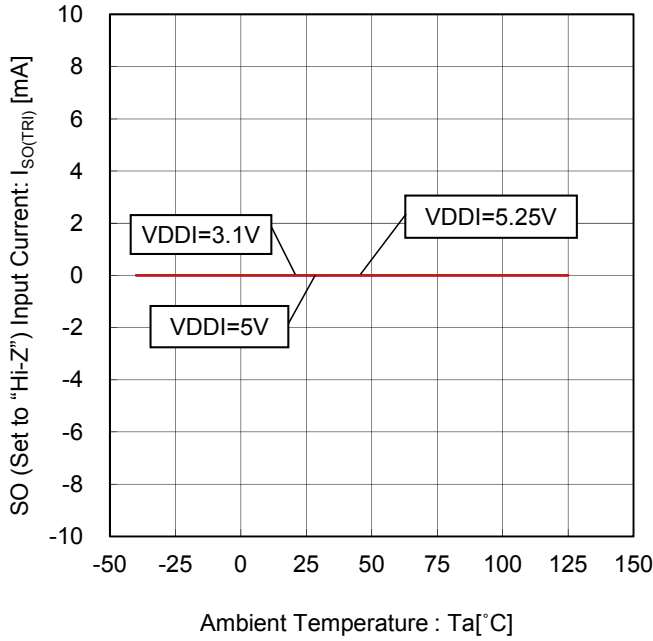

Figure 93. SO (Set to "Hi-Z") Input Current vs Ambient Temperature

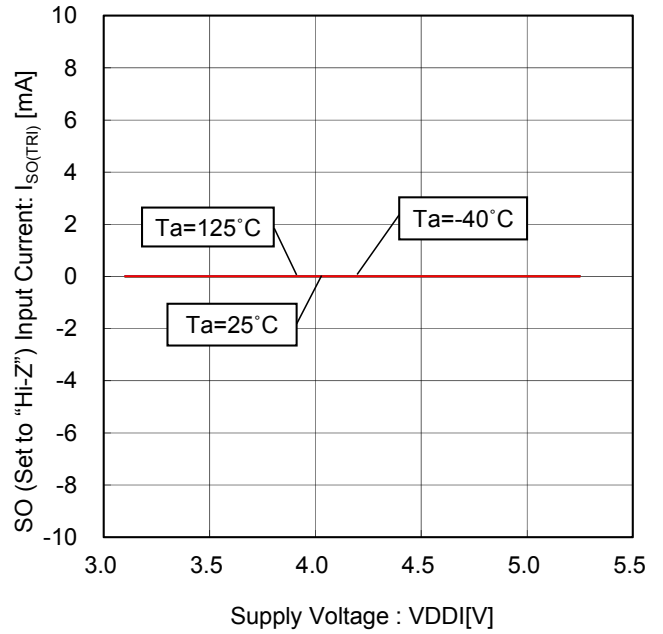

Figure 94. SO (Set to "Hi-Z") Input Current vs Supply Voltage

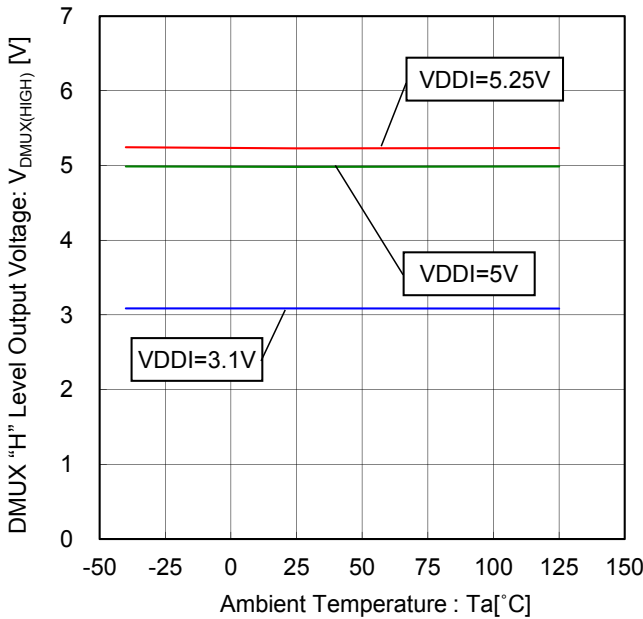

Figure 95. DMUX "H" Level Output Voltage vs Ambient Temperature (I_{SOURCE}=200μA)

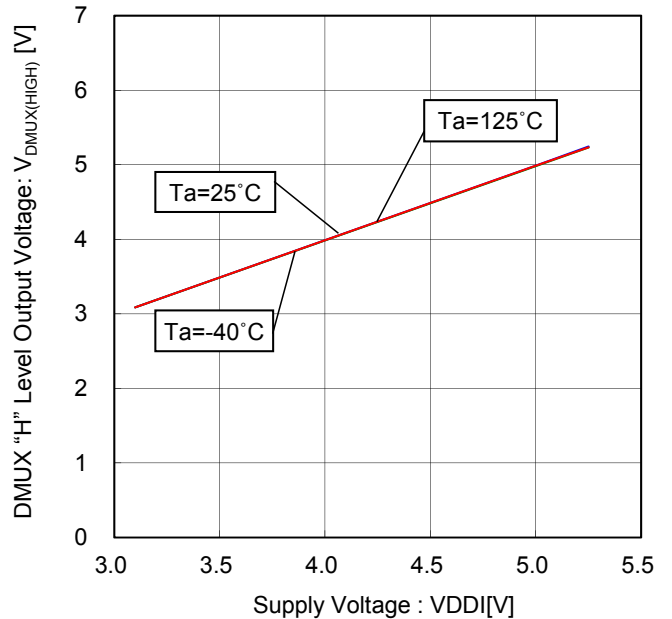

Figure 96. DMUX "H" Level Output Voltage vs Supply Voltage (I_{SOURCE}=200μA)

Typical Performance Curves - continued

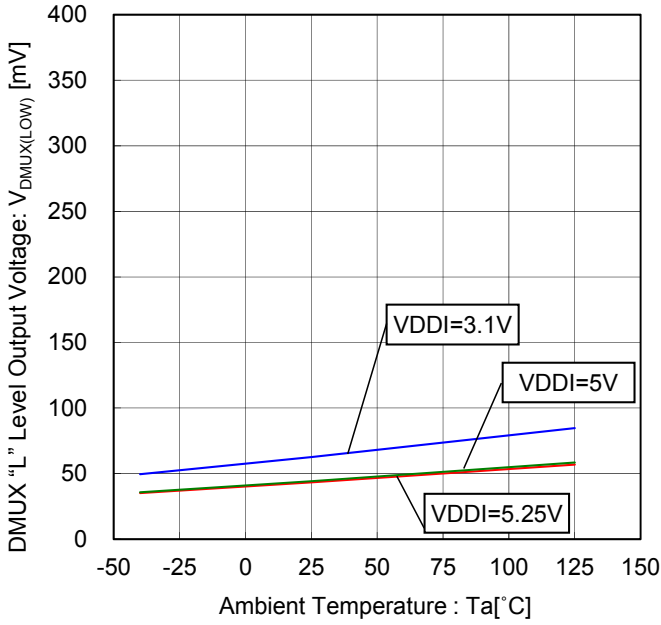

Figure 97. DMUX "L" Level Output Voltage vs Ambient Temperature ($I_{SINK} = 1.6mA$)

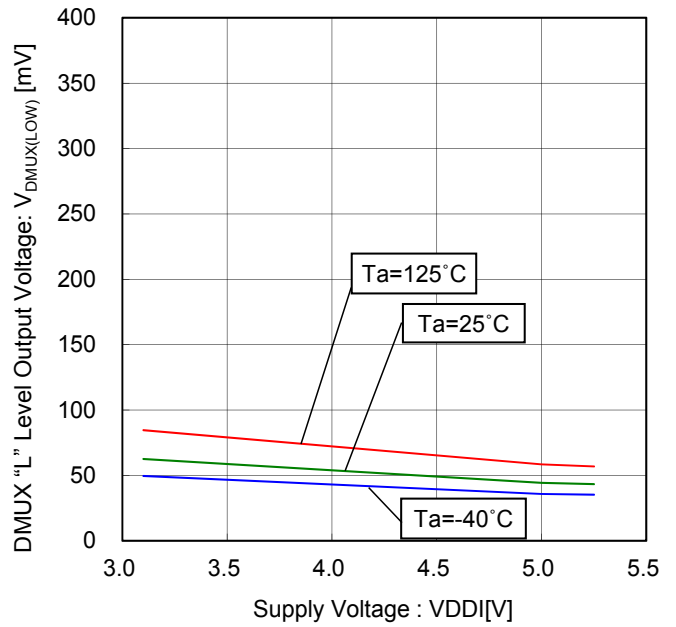

Figure 98. DMUX "L" Level Output Voltage vs Supply Voltage ($I_{SINK} = 1.6mA$)

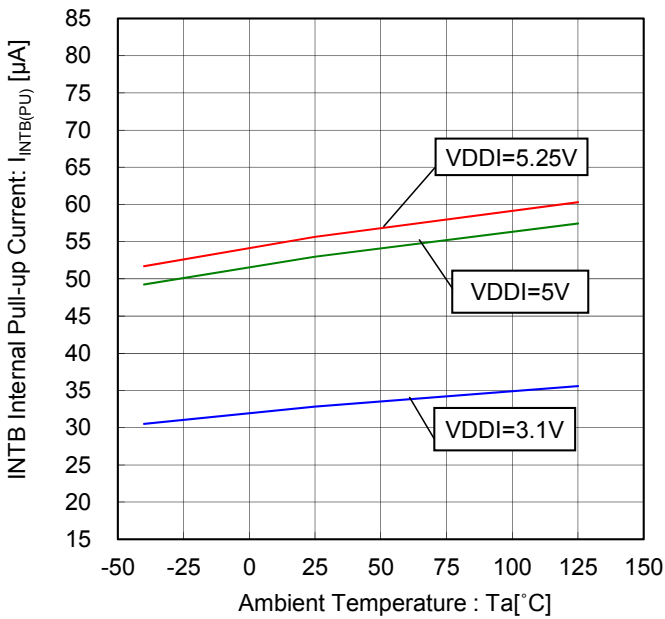

Figure 99. INTB Internal Pull-up Current vs Ambient Temperature

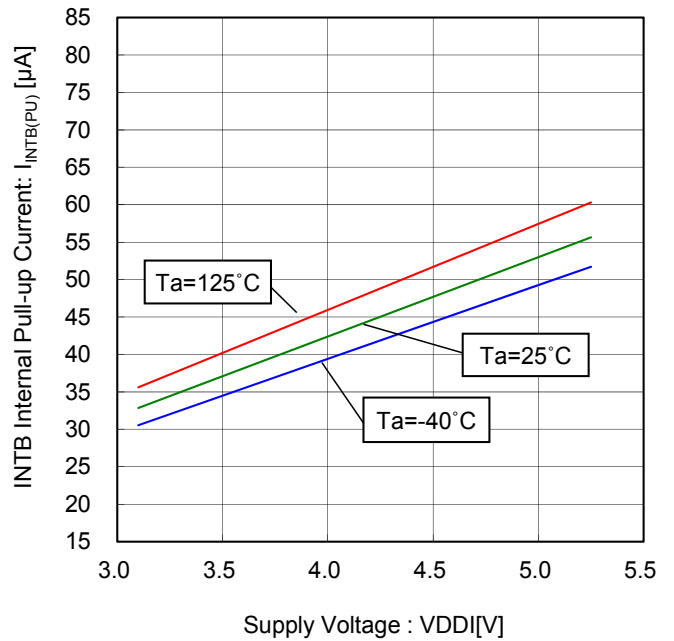

Figure 100. INTB Internal Pull-up Current vs Supply Voltage

Typical Performance Curves - continued

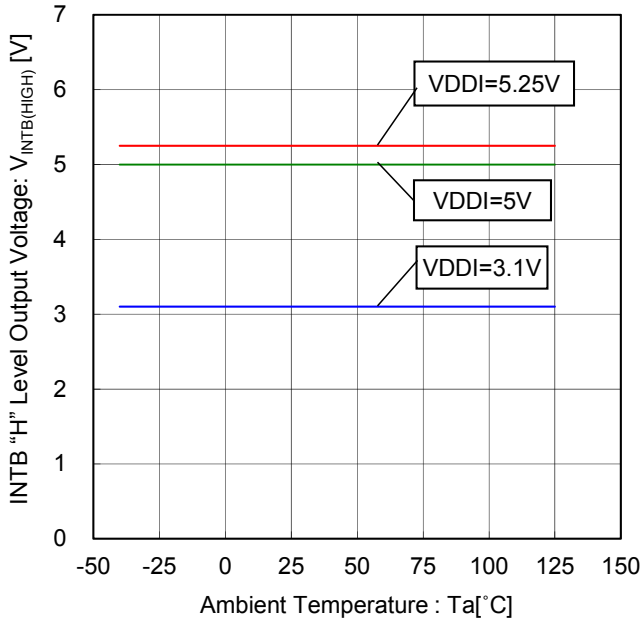

Figure 101. INTB "H" Level Output Voltage vs Ambient Temperature (INTB=OPEN)

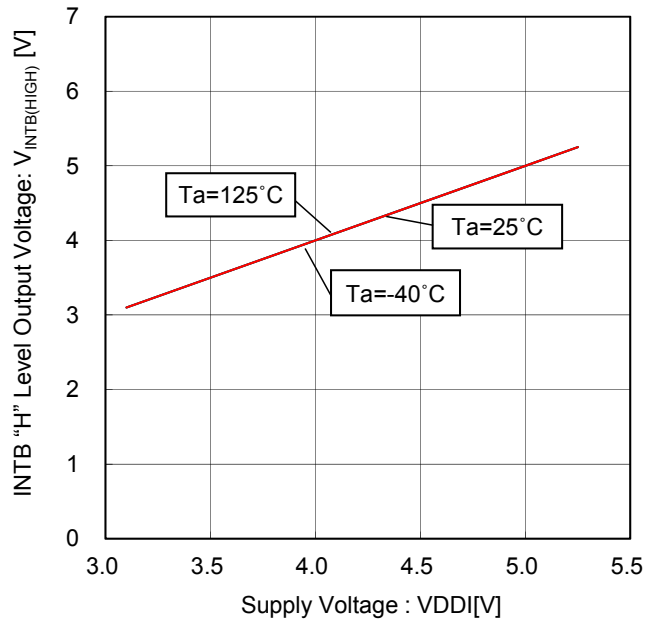

Figure 102. INTB "H" Level Output Voltage vs Supply Voltage (INTB=OPEN)

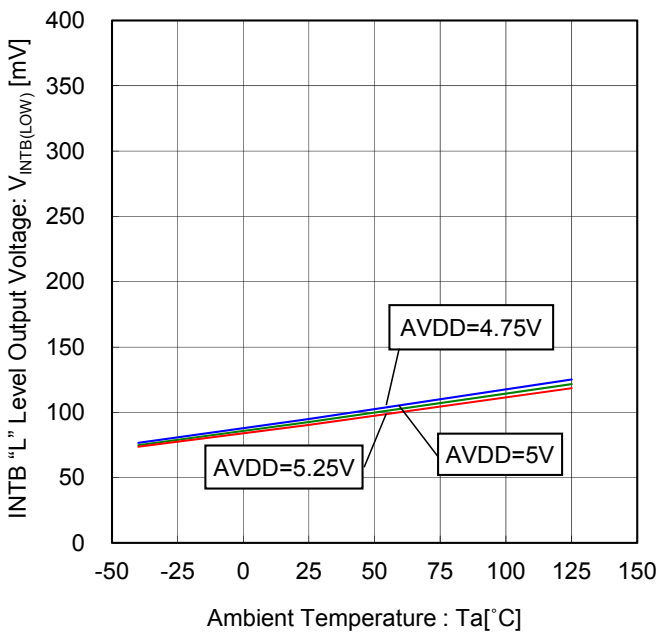

Figure 103. INTB "L" Level Output Voltage vs Ambient Temperature (I_{SINK}=1.0mA)

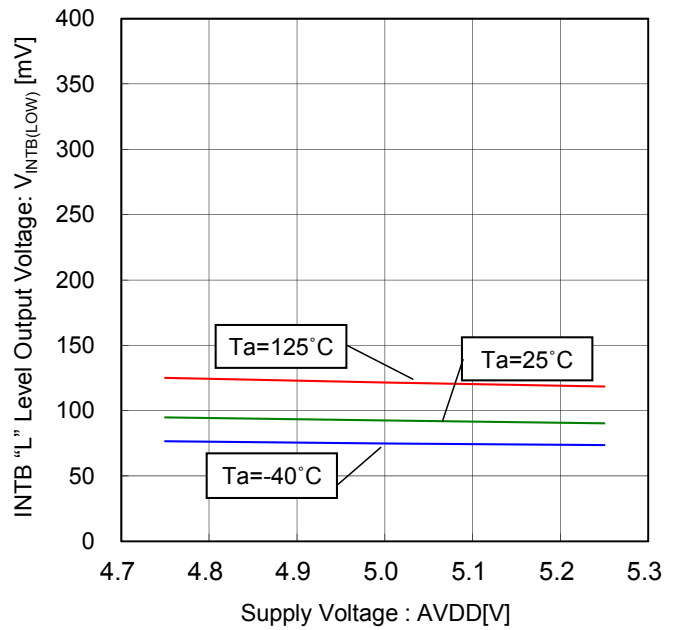

Figure 104. INTB "L" Level Output Voltage vs Supply Voltage (I_{SINK}=1.0mA)

Typical Performance Curves - continued

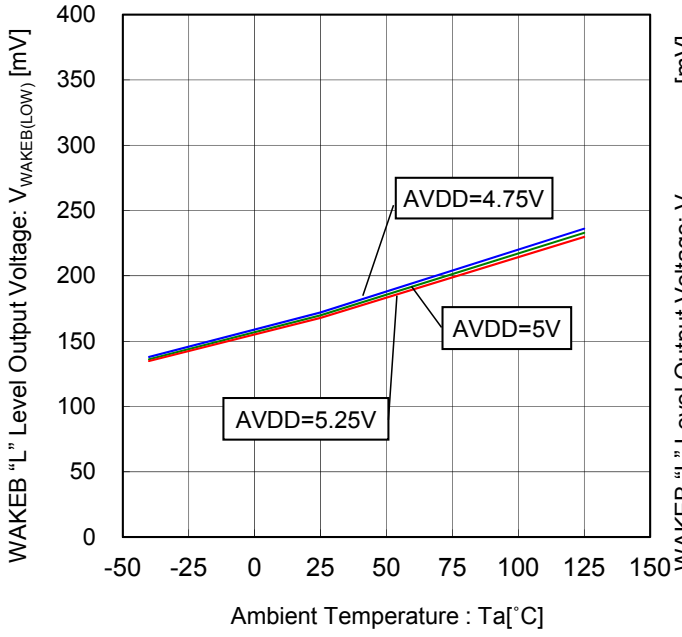

Figure 105. WAKEB "L" Level Output Voltage vs Ambient Temperature (WAKEB=1.0mA)

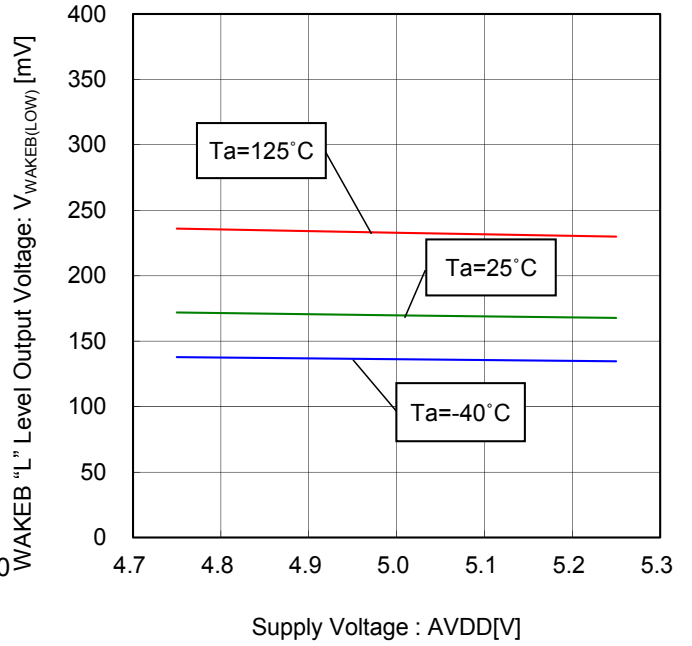

Figure 106. WAKEB "L" Level Output Voltage vs Supply Voltage (WAKEB=1.0mA)

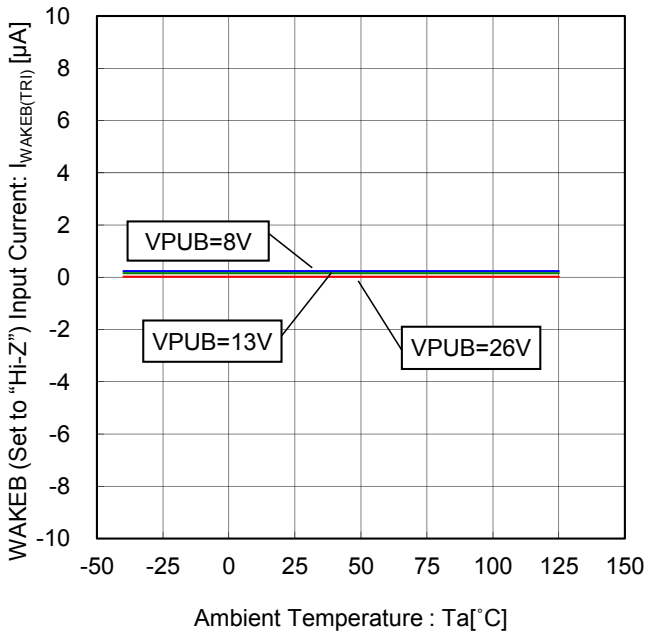

Figure 107. WAKEB (Set to "Hi-Z") Input Current vs Ambient Temperature

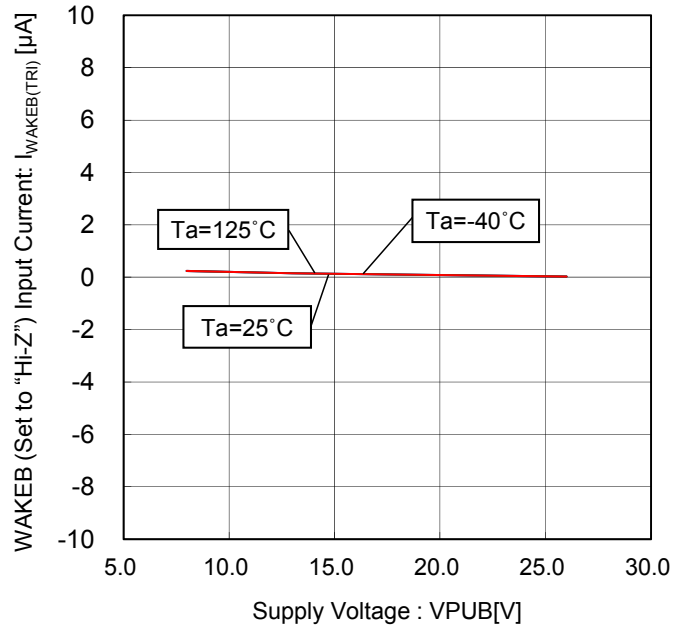

Figure 108. WAKEB (Set to "Hi-Z") Input Current vs Supply Voltage

Typical Performance Curves - continued

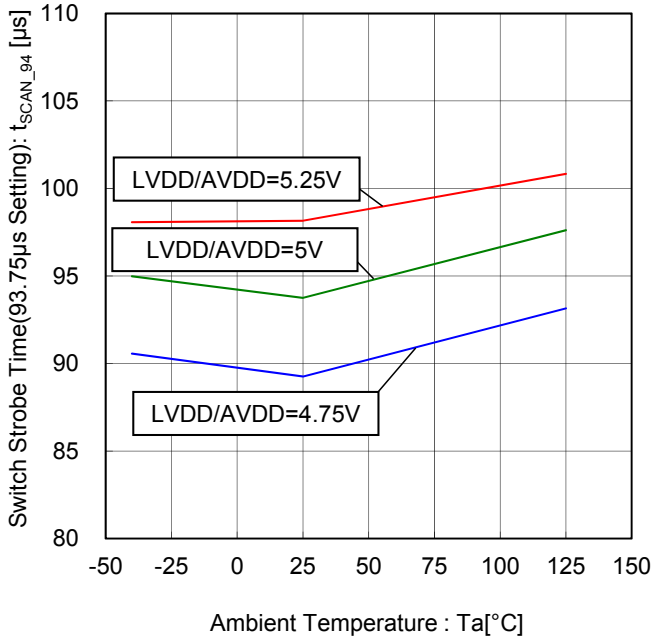

Figure 109. Switch Strobe Time(93.75µs Setting) vs Ambient Temperature

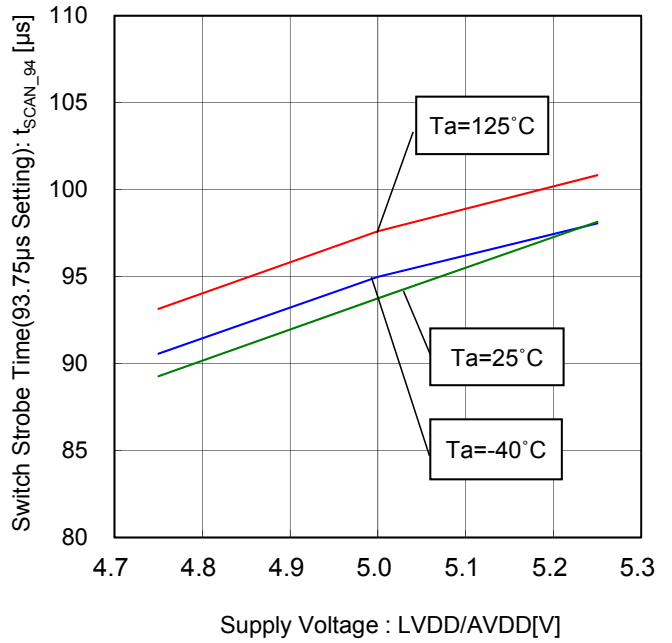

Figure 110. Switch Strobe Time(93.75µs Setting) vs Supply Voltage

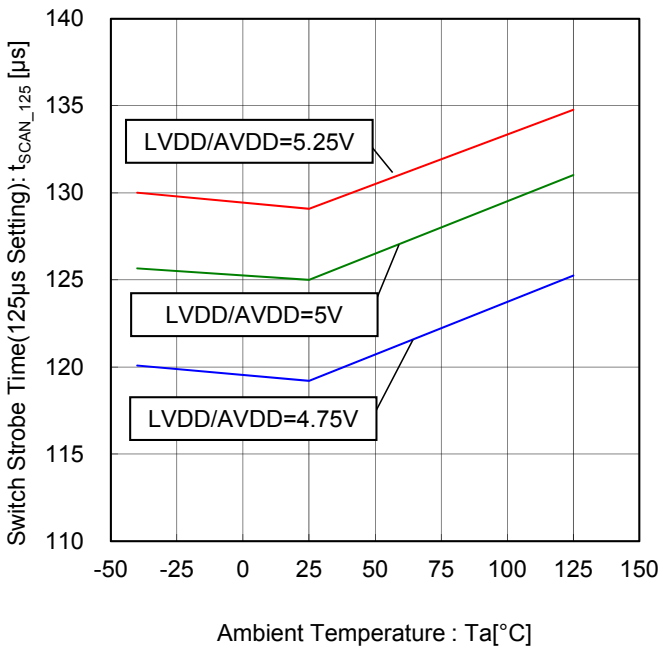

Figure 111. Switch Strobe Time(125µs Setting) vs Ambient Temperature

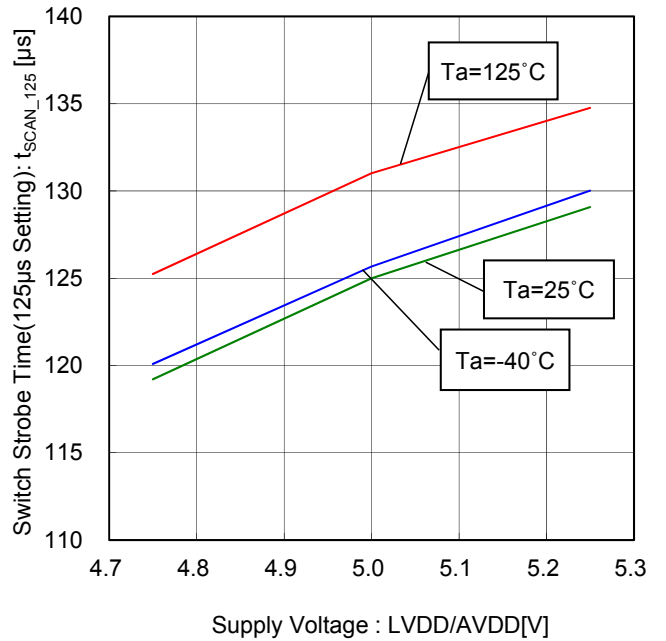

Figure 112. Switch Strobe Time(125µs Setting) vs Supply Voltage

Typical Performance Curves - continued

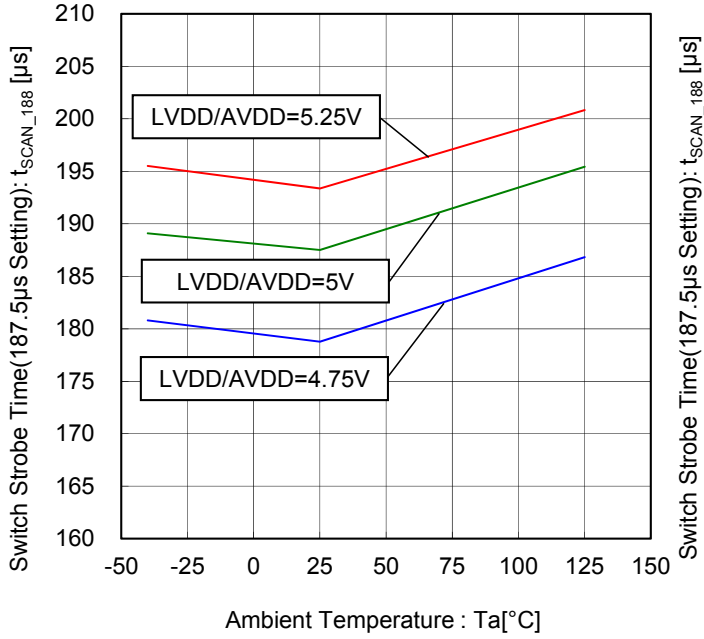

Figure 113. Switch Strobe Time(187.5µs Setting) vs Ambient Temperature

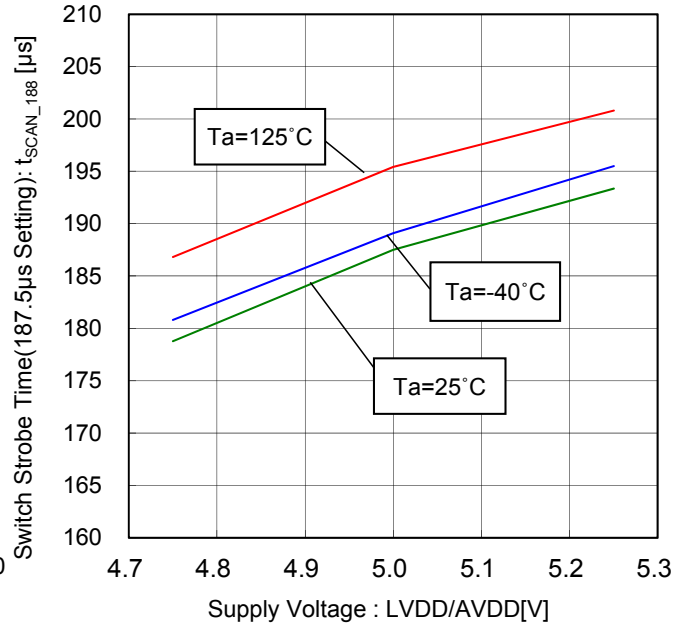

Figure 114. Switch Strobe Time(187.5µs Setting) vs Supply Voltage

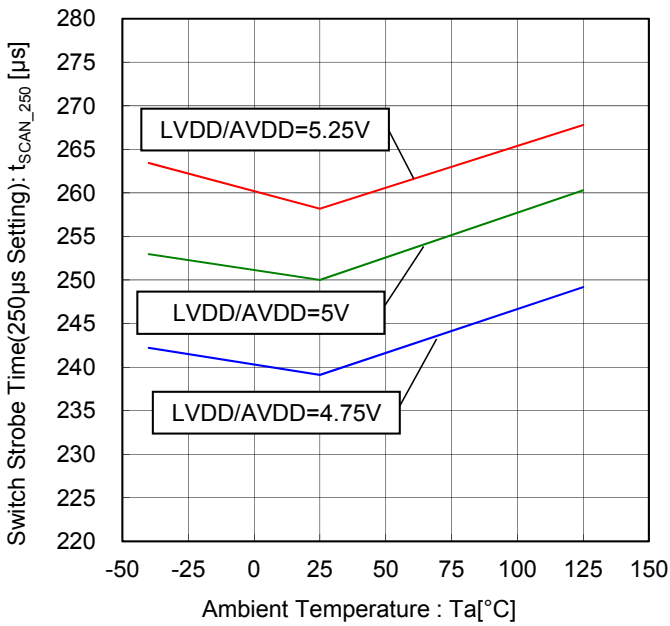

Figure 115. Switch Strobe Time(250µs Setting) vs Ambient Temperature

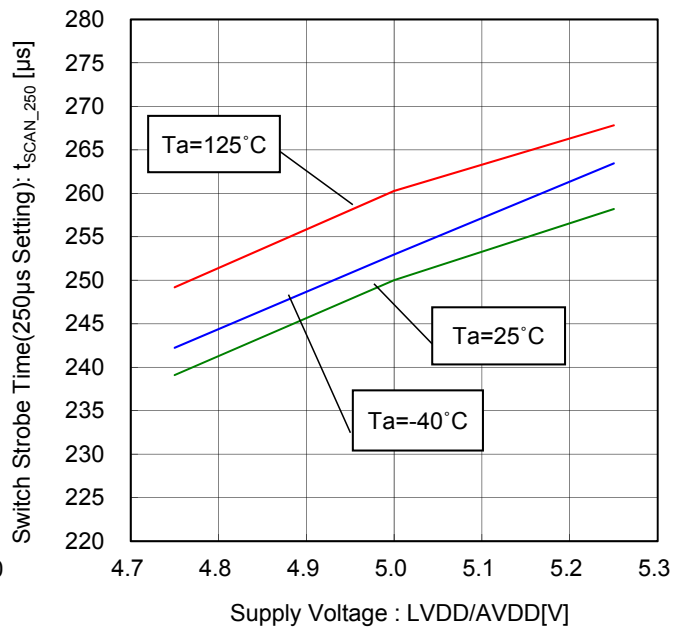

Figure 116. Switch Strobe Time(250µs Setting) vs Supply Voltage

Typical Performance Curves - continued

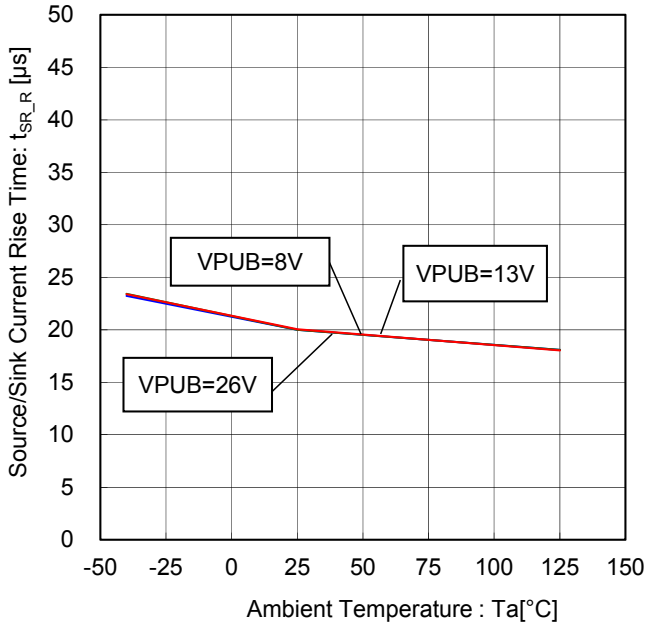

Figure 117. Source/Sink Current Rise Time vs Ambient Temperature (FSQ="0", FSQZ/A/B="0", 10mA Setting, Load Resistance=100Ω)

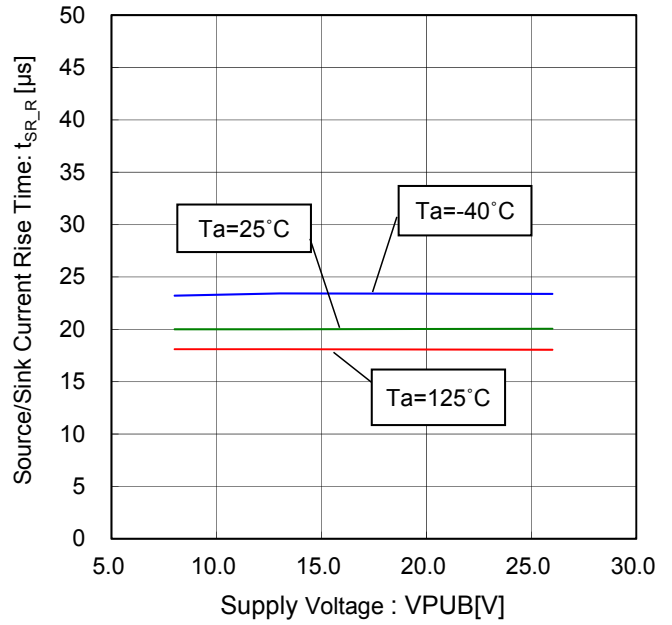

Figure 118. Source/Sink Current Rise Time vs Supply Voltage (FSQ="0", FSQZ/A/B="0", 10mA Setting, Load Resistance=100Ω)

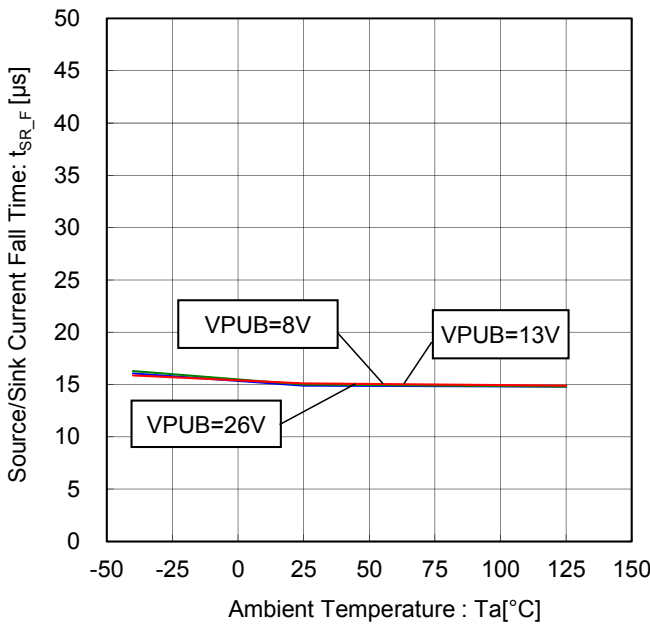

Figure 119. Source/Sink Current Fall Time vs Ambient Temperature (FSQ="0", FSQZ/A/B="0", 10mA Setting, Load Resistance=100Ω)

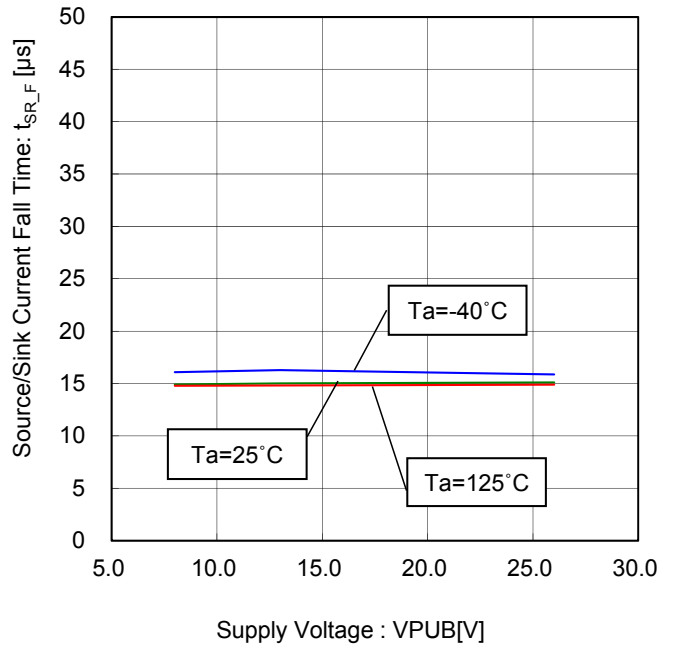

Figure 120. Source/Sink Current Fall Time vs Supply Voltage (FSQ="0", FSQZ/A/B="0", 10mA Setting, Load Resistance=100Ω)

Application Circuit Examples

1. Example of Application Circuit and its External Components

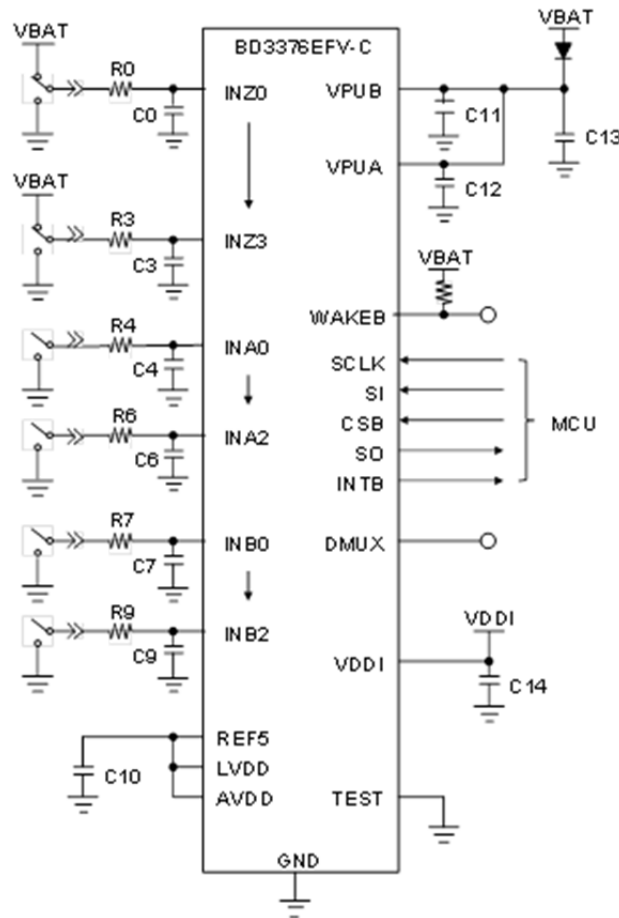

Figure 121. Example of Application Circuit and its External Components

- Capacitor (C11, C12, C14) at Power Supply Pins (VPUA, VPUB, VDDI)
Insert a 0.1μF capacitor between each power supply pin (VPUA, VPUB, and VDDI) and ground. Make sure to design the external components with sufficient margin for the intended application. It is recommended to use capacitors with excellent voltage and temperature characteristics.
- Capacitor (C10) at REF5
In order to prevent oscillation, a capacitor needs to be placed between the REF5 output pin and ground. It is recommended to use a capacitor (electrolytic, tantalum, or ceramic of at least 4.7μF). Make sure that capacitance of 4.7μF or higher is maintained at the intended operating supply voltage and temperature range. Temperature change can cause fluctuation in capacitance, which may lead to oscillation. If a ceramic capacitor is chosen, it is recommended to use X5R, X7R, or any others with better temperature and DC biasing characteristics and higher voltage tolerance.
- Capacitor(C0 to C9) at Switch Pin (INZ, INA, INB)
It is recommended to use at least 0.1μF capacitors as protection against ESD. Make sure to design the external circuit with sufficient margin for the intended application. Use capacitors with application specific voltage and temperature characteristics.
- Resistor (R0 to R9) at Switch Pin (INZ, INA, INB)
Choose the appropriate resistor to reduce EMI noise. Design the circuit so the pin voltage does not fall below the threshold voltage defined by ground float of [Load Resistance] x [Wetting Current] (when wetting current is set to source) or voltage drop (when wetting current is set to sink) may occur.

Application Circuit Examples - continued

2. Example of Parallel Connection Circuit

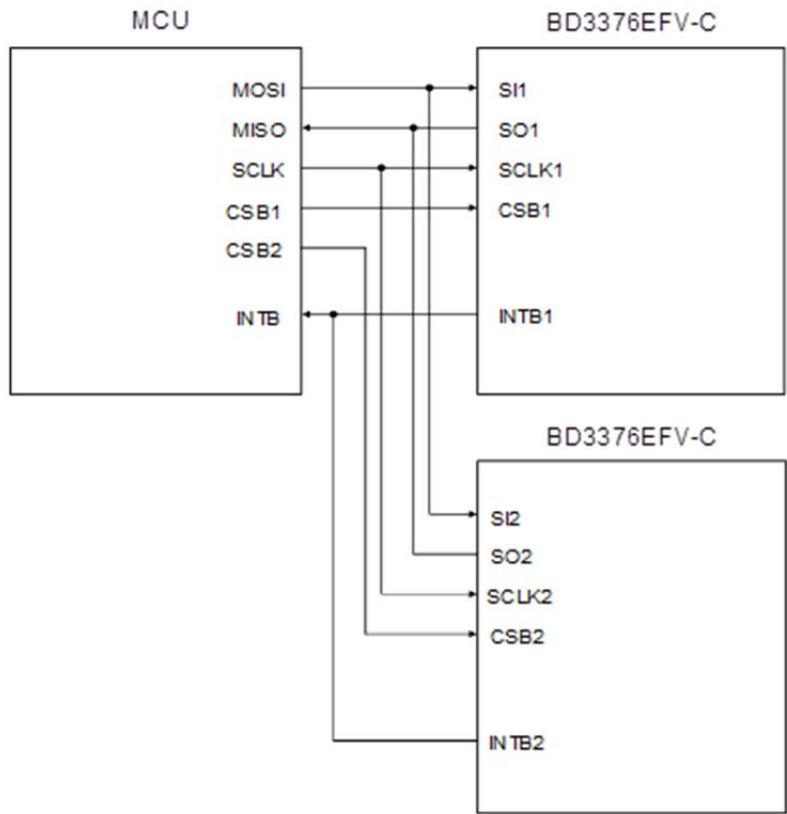
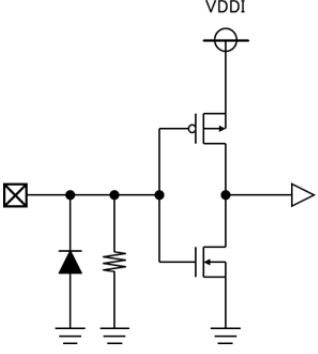
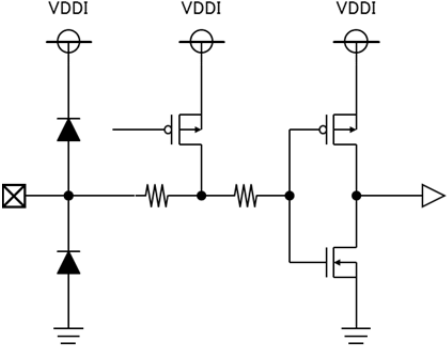
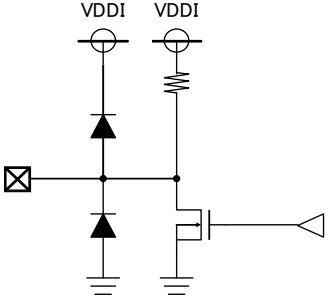
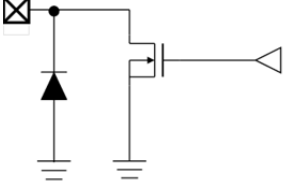
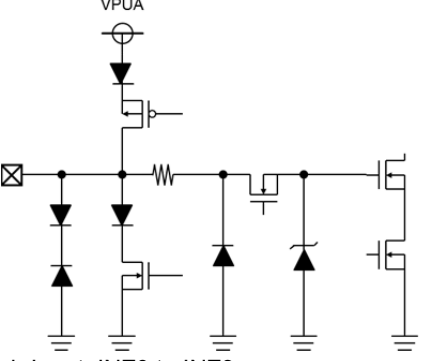
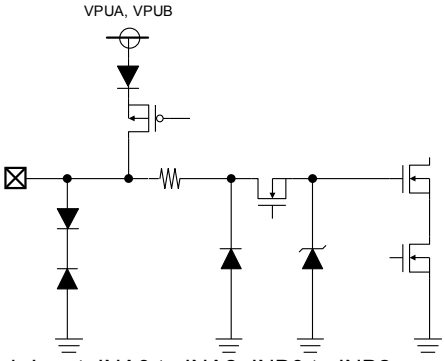
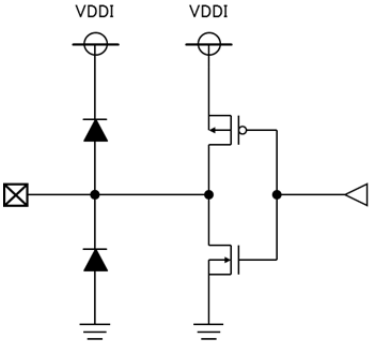
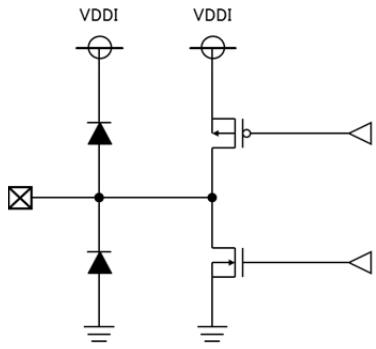

Figure 122. Example of Parallel Connection Circuit

- Parallel Connection
Please prepare CSB terminals respectively.

I / O Equivalence Circuit

Type	Equivalence circuit	Type	Equivalence circuit
A	 <p>Input: SI, SCLK (with an Internal Pull-down Resistor)</p>	B	 <p>Input: CSB (with an Internal Pull-up Current Source)</p>
C	 <p>Open-drain interrupt Output: INTB (with an Internal Pull-up Resistor)</p>	D	 <p>Open-drain Output: WAKEB</p>
E	 <p>Switch Input: INZ0 to INZ3 (with an Internal Pull-up/down Current Source)</p>	F	 <p>Switch Input: INA0 to INA2, INB0 to INB2 (with an Internal Pull-up Current Source)</p>
G	 <p>Output: DMUX</p>	H	 <p>Output: SO</p>

I / O Equivalence Circuit- continued

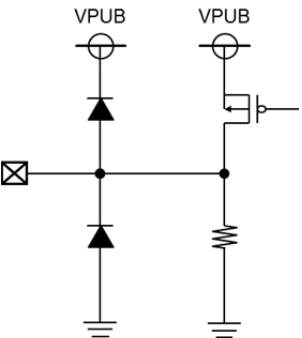
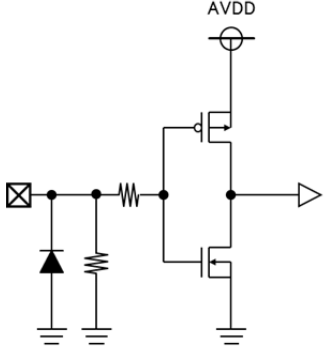
Type	Equivalence circuit	Type	Equivalence circuit
I	 <p>Output: REF5</p>	 <p>Input: TEST (with an Internal Pull-down Resistor)</p>	

Operational Notes

1. Reverse Connection of Power Supply

Connecting the power supply in reverse polarity can damage the IC. Take precautions against reverse polarity when connecting the power supply, such as mounting an external diode between the power supply and the IC's power supply pins.

2. Power Supply Lines

Design the PCB layout pattern to provide low impedance supply lines. Separate the ground and supply lines of the digital and analog blocks to prevent noise in the ground and supply lines of the digital block from affecting the analog block. Furthermore, connect a capacitor to ground at all power supply pins. Consider the effect of temperature and aging on the capacitance value when using electrolytic capacitors.

3. Ground Voltage

Except for pins the output and the input of which were designed to go below ground, ensure that no pins are at a voltage below that of the ground pin at any time, even during transient condition.

4. Ground Wiring Pattern

When using both small-signal and large-current ground traces, the two ground traces should be routed separately but connected to a single ground at the reference point of the application board to avoid fluctuations in the small-signal ground caused by large currents. Also ensure that the ground traces of external components do not cause variations on the ground voltage. The ground lines must be as short and thick as possible to reduce line impedance.

5. Thermal Consideration

Should by any chance the maximum junction temperature rating be exceeded the rise in temperature of the chip may result in deterioration of the properties of the chip. In case of exceeding this absolute maximum rating, increase the board size and copper area to prevent exceeding the maximum junction temperature rating.

6. Recommended Operating Conditions

These conditions represent a range within which the expected characteristics of the IC can be approximately obtained. The electrical characteristics are guaranteed under the conditions of each parameter.

7. Inrush Current

When power is first supplied to the IC, it is possible that the internal logic may be unstable and inrush current may flow instantaneously due to the internal powering sequence and delays, especially if the IC has more than one power supply. Therefore, give special consideration to power coupling capacitance, power wiring, width of ground wiring, and routing of connections.

8. Operation Under Strong Electromagnetic Field

Operating the IC in the presence of a strong electromagnetic field may cause the IC to malfunction.

9. Testing on Application Boards

When testing the IC on an application board, connecting a capacitor directly to a low-impedance output pin may subject the IC to stress. Always discharge capacitors completely after each process or step. The IC's power supply should always be turned off completely before connecting or removing it from the test setup during the inspection process. To prevent damage from static discharge, ground the IC during assembly and use similar precautions during transport and storage.

10. Inter-pin Short and Mounting Errors

Ensure that the direction and position are correct when mounting the IC on the PCB. Incorrect mounting may result in damaging the IC. Avoid nearby pins being shorted to each other especially to ground, power supply and output pin. Inter-pin shorts could be due to many reasons such as metal particles, water droplets (in very humid environment) and unintentional solder bridge deposited in between pins during assembly to name a few.

11. Unused Input Pins

Input pins of an IC are often connected to the gate of a MOS transistor. The gate has extremely high impedance and extremely low capacitance. If left unconnected, the electric field from the outside can easily charge it. The small charge acquired in this way is enough to produce a significant effect on the conduction through the transistor and cause unexpected operation of the IC. So unless otherwise specified, unused input pins should be connected to the power supply or ground line.

Operational Notes – continued

12. Regarding the Input Pin of the IC

This monolithic IC contains P+ isolation and P substrate layers between adjacent elements in order to keep them isolated. P-N junctions are formed at the intersection of the P layers with the N layers of other elements, creating a parasitic diode or transistor. For example (refer to figure below):

When $GND > Pin A$ and $GND > Pin B$, the P-N junction operates as a parasitic diode.

When $GND > Pin B$, the P-N junction operates as a parasitic transistor.

Parasitic diodes inevitably occur in the structure of the IC. The operation of parasitic diodes can result in mutual interference among circuits, operational faults, or physical damage. Therefore, conditions that cause these diodes to operate, such as applying a voltage lower than the GND voltage to an input pin (and thus to the P substrate) should be avoided.

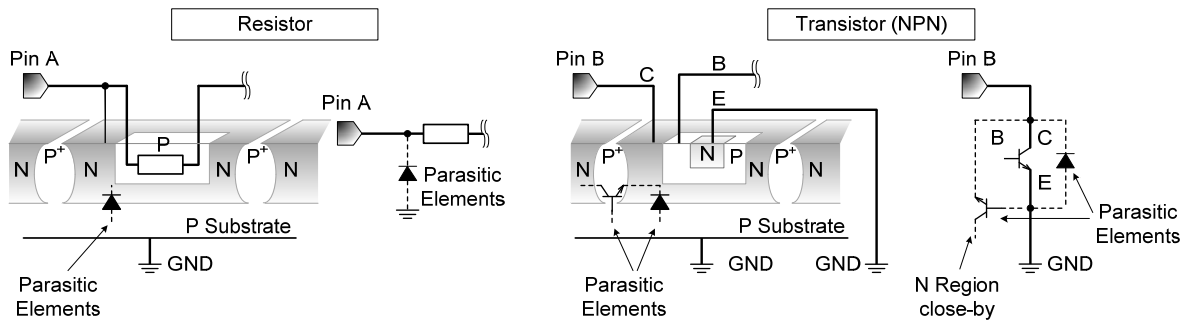

Figure 123. Example of monolithic IC structure

13. Ceramic Capacitor

When using a ceramic capacitor, determine a capacitance value considering the change of capacitance with temperature and the decrease in nominal capacitance due to DC bias and others.

14. Thermal Shutdown Circuit(TSD)

This IC has a built-in thermal shutdown circuit that prevents heat damage to the IC. Normal operation should always be within the IC's maximum junction temperature rating. If however the rating is exceeded for a continued period, the junction temperature (T_j) will rise which will activate the TSD circuit that will turn OFF all output pins. When the T_j falls below the TSD threshold, the circuits are automatically restored to normal operation.

Note that the TSD circuit operates in a situation that exceeds the absolute maximum ratings and therefore, under no circumstances, should the TSD circuit be used in a set design or for any purpose other than protecting the IC from heat damage.

Ordering Information

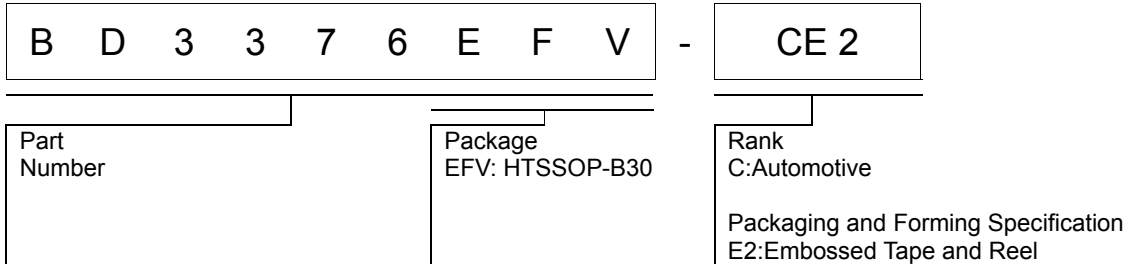

Figure 124. Ordering Information

Marking Diagram

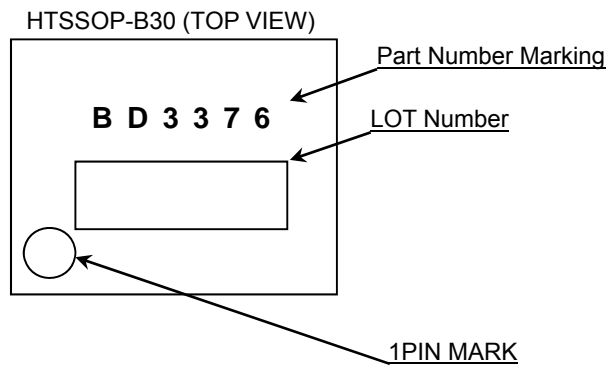
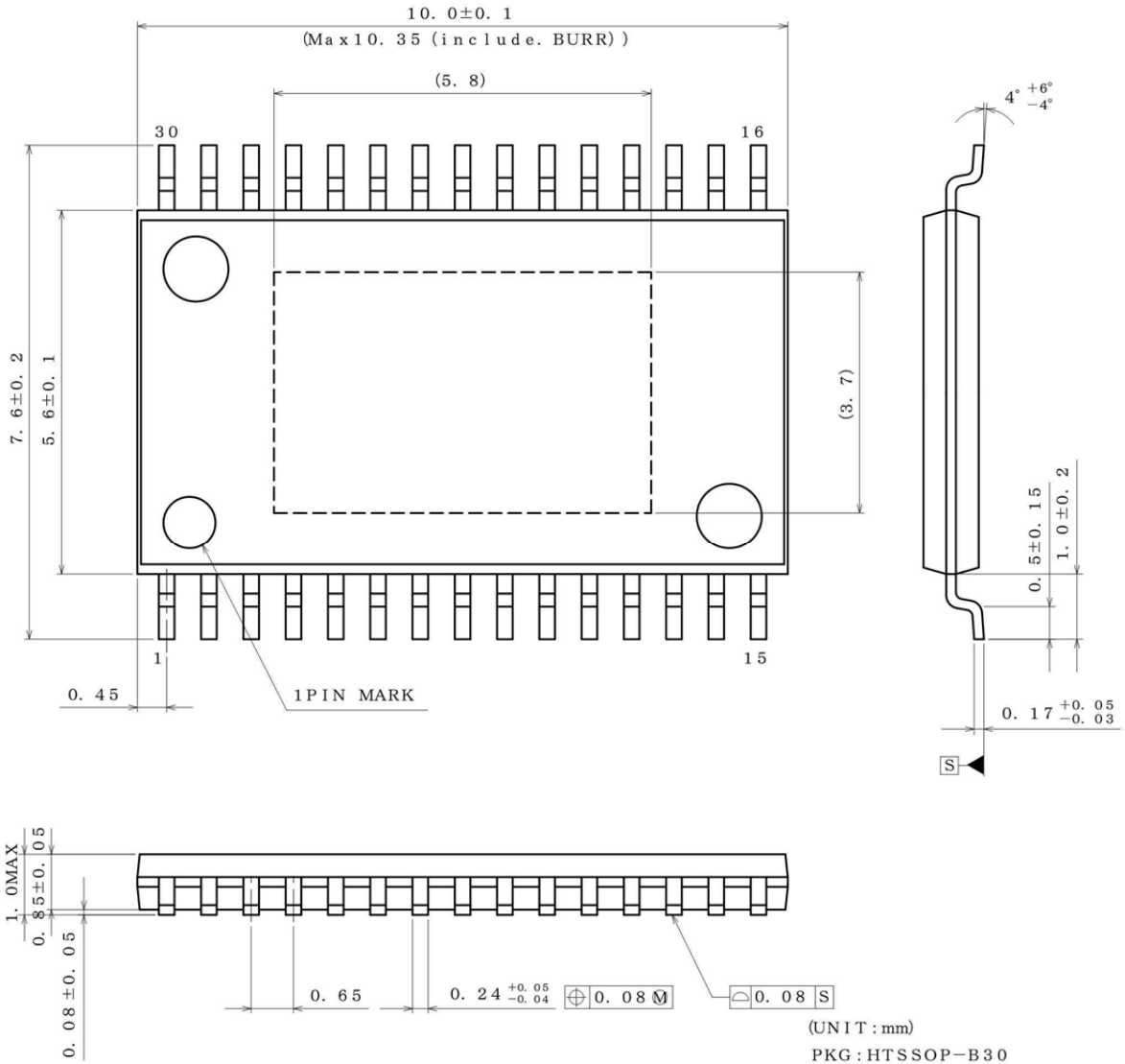

Figure 125. Marking Diagram

Physical Dimension, Tape and Reel Information

Package Name	HTSSOP-B30
--------------	------------



(UNIT : mm)
 PKG : HTSSOP-B30
 Drawing No. EX200-5002

<Tape and Reel information>

Tape	Embossed carrier tape (with dry pack)
Quantity	2000pcs
Direction of feed	E2 (The direction is the 1pin of product is at the upper left when you hold reel on the left hand and you pull out the tape on the right hand)

* Order quantity needs to be multiple of the minimum quantity.

Revision History

Date	Rev.	History
02.Sep.2016	001	(Japanese Only)
25.Apr.2017	002	New Release

Notice

Precaution on using ROHM Products

1. If you intend to use our Products in devices requiring extremely high reliability (such as medical equipment ^(Note 1), aircraft/spacecraft, nuclear power controllers, etc.) and whose malfunction or failure may cause loss of human life, bodily injury or serious damage to property ("Specific Applications"), please consult with the ROHM sales representative in advance. Unless otherwise agreed in writing by ROHM in advance, ROHM shall not be in any way responsible or liable for any damages, expenses or losses incurred by you or third parties arising from the use of any ROHM's Products for Specific Applications.

(Note1) Medical Equipment Classification of the Specific Applications

JAPAN	USA	EU	CHINA
CLASS III	CLASS III	CLASS II b	CLASS III
CLASS IV		CLASS III	

2. ROHM designs and manufactures its Products subject to strict quality control system. However, semiconductor products can fail or malfunction at a certain rate. Please be sure to implement, at your own responsibilities, adequate safety measures including but not limited to fail-safe design against the physical injury, damage to any property, which a failure or malfunction of our Products may cause. The following are examples of safety measures:
 - [a] Installation of protection circuits or other protective devices to improve system safety
 - [b] Installation of redundant circuits to reduce the impact of single or multiple circuit failure
3. Our Products are not designed under any special or extraordinary environments or conditions, as exemplified below. Accordingly, ROHM shall not be in any way responsible or liable for any damages, expenses or losses arising from the use of any ROHM's Products under any special or extraordinary environments or conditions. If you intend to use our Products under any special or extraordinary environments or conditions (as exemplified below), your independent verification and confirmation of product performance, reliability, etc. prior to use, must be necessary:
 - [a] Use of our Products in any types of liquid, including water, oils, chemicals, and organic solvents
 - [b] Use of our Products outdoors or in places where the Products are exposed to direct sunlight or dust
 - [c] Use of our Products in places where the Products are exposed to sea wind or corrosive gases, including Cl₂, H₂S, NH₃, SO₂, and NO₂
 - [d] Use of our Products in places where the Products are exposed to static electricity or electromagnetic waves
 - [e] Use of our Products in proximity to heat-producing components, plastic cords, or other flammable items
 - [f] Sealing or coating our Products with resin or other coating materials
 - [g] Use of our Products without cleaning residue of flux (even if you use no-clean type fluxes, cleaning residue of flux is recommended); or Washing our Products by using water or water-soluble cleaning agents for cleaning residue after soldering
 - [h] Use of the Products in places subject to dew condensation
4. The Products are not subject to radiation-proof design.
5. Please verify and confirm characteristics of the final or mounted products in using the Products.
6. In particular, if a transient load (a large amount of load applied in a short period of time, such as pulse. is applied, confirmation of performance characteristics after on-board mounting is strongly recommended. Avoid applying power exceeding normal rated power; exceeding the power rating under steady-state loading condition may negatively affect product performance and reliability.
7. De-rate Power Dissipation depending on ambient temperature. When used in sealed area, confirm that it is the use in the range that does not exceed the maximum junction temperature.
8. Confirm that operation temperature is within the specified range described in the product specification.
9. ROHM shall not be in any way responsible or liable for failure induced under deviant condition from what is defined in this document.

Precaution for Mounting / Circuit board design

1. When a highly active halogenous (chlorine, bromine, etc.) flux is used, the residue of flux may negatively affect product performance and reliability.
2. In principle, the reflow soldering method must be used on a surface-mount products, the flow soldering method must be used on a through hole mount products. If the flow soldering method is preferred on a surface-mount products, please consult with the ROHM representative in advance.

For details, please refer to ROHM Mounting specification

Precautions Regarding Application Examples and External Circuits

1. If change is made to the constant of an external circuit, please allow a sufficient margin considering variations of the characteristics of the Products and external components, including transient characteristics, as well as static characteristics.
2. You agree that application notes, reference designs, and associated data and information contained in this document are presented only as guidance for Products use. Therefore, in case you use such information, you are solely responsible for it and you must exercise your own independent verification and judgment in the use of such information contained in this document. ROHM shall not be in any way responsible or liable for any damages, expenses or losses incurred by you or third parties arising from the use of such information.

Precaution for Electrostatic

This Product is electrostatic sensitive product, which may be damaged due to electrostatic discharge. Please take proper caution in your manufacturing process and storage so that voltage exceeding the Products maximum rating will not be applied to Products. Please take special care under dry condition (e.g. Grounding of human body / equipment / solder iron, isolation from charged objects, setting of Ionizer, friction prevention and temperature / humidity control).

Precaution for Storage / Transportation

1. Product performance and soldered connections may deteriorate if the Products are stored in the places where:
 - [a] the Products are exposed to sea winds or corrosive gases, including Cl₂, H₂S, NH₃, SO₂, and NO₂
 - [b] the temperature or humidity exceeds those recommended by ROHM
 - [c] the Products are exposed to direct sunshine or condensation
 - [d] the Products are exposed to high Electrostatic
2. Even under ROHM recommended storage condition, solderability of products out of recommended storage time period may be degraded. It is strongly recommended to confirm solderability before using Products of which storage time is exceeding the recommended storage time period.
3. Store / transport cartons in the correct direction, which is indicated on a carton with a symbol. Otherwise bent leads may occur due to excessive stress applied when dropping of a carton.
4. Use Products within the specified time after opening a humidity barrier bag. Baking is required before using Products of which storage time is exceeding the recommended storage time period.

Precaution for Product Label

A two-dimensional barcode printed on ROHM Products label is for ROHM's internal use only.

Precaution for Disposition

When disposing Products please dispose them properly using an authorized industry waste company.

Precaution for Foreign Exchange and Foreign Trade act

Since concerned goods might be fallen under listed items of export control prescribed by Foreign exchange and Foreign trade act, please consult with ROHM in case of export.

Precaution Regarding Intellectual Property Rights

1. All information and data including but not limited to application example contained in this document is for reference only. ROHM does not warrant that foregoing information or data will not infringe any intellectual property rights or any other rights of any third party regarding such information or data.
2. ROHM shall not have any obligations where the claims, actions or demands arising from the combination of the Products with other articles such as components, circuits, systems or external equipment (including software).
3. No license, expressly or implied, is granted hereby under any intellectual property rights or other rights of ROHM or any third parties with respect to the Products or the information contained in this document. Provided, however, that ROHM will not assert its intellectual property rights or other rights against you or your customers to the extent necessary to manufacture or sell products containing the Products, subject to the terms and conditions herein.

Other Precaution

1. This document may not be reprinted or reproduced, in whole or in part, without prior written consent of ROHM.
2. The Products may not be disassembled, converted, modified, reproduced or otherwise changed without prior written consent of ROHM.
3. In no event shall you use in any way whatsoever the Products and the related technical information contained in the Products or this document for any military purposes, including but not limited to, the development of mass-destruction weapons.
4. The proper names of companies or products described in this document are trademarks or registered trademarks of ROHM, its affiliated companies or third parties.

General Precaution

1. Before you use our Products, you are requested to carefully read this document and fully understand its contents. ROHM shall not be in any way responsible or liable for failure, malfunction or accident arising from the use of any ROHM's Products against warning, caution or note contained in this document.
2. All information contained in this document is current as of the issuing date and subject to change without any prior notice. Before purchasing or using ROHM's Products, please confirm the latest information with a ROHM sales representative.
3. The information contained in this document is provided on an "as is" basis and ROHM does not warrant that all information contained in this document is accurate and/or error-free. ROHM shall not be in any way responsible or liable for any damages, expenses or losses incurred by you or third parties resulting from inaccuracy or errors of or concerning such information.