

JBC C245159E**Chisel Cartridge 0.8 x 0.4**

C245E Cartridges have been designed with a thicker iron layer what makes this tip ideal for tough and repetitive works in mass production. A thicker iron layer reduces the thermal efficiency.

They are appropriate for general soldering purposes and they are perfect for both SMD components or for applications with high power requirements such as ground plane soldering.

They work with T245 Handles.

They last 5 times longer than other brands thanks to the JBC Most Efficient Soldering System and the Sleep & Hibernation features.

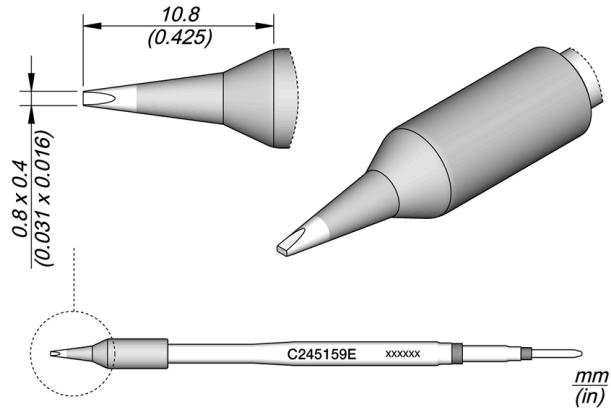
**REFERENCE****C245159E****SPECIFICATIONS**

Net weight 0,008 kg (0.02lb)

WEIGHT AND DIMENSIONS

8 gr (0.02 lb)

11 gr (0.03 lb)

110 x 12 x 12 mm

Copyright © 2024 JBC Soldering S.L. | [Legal Notice](#) | [Privacy Policy](#) | [Terms and Conditions](#) | [Cookie policy](#) | [Internal Communication](#) | [RSS Feed](#) | [JBC Store](#) | [Contact Us](#)

CONNECTABLES**Compatible tools**

T245-A

General Purpose Handle



T245-PA

Blue Grip General Purpose Handle



T245-NA

Nitrogen General Purpose Handle