

### Small Signal Diode



#### Features

- ◇ Fast switching speed
- ◇ Surface device type mounting
- ◇ Moisture sensitivity level 1
- ◇ Matte Tin(Sn) lead finish with Nickel(Ni) underplate
- ◇ Pb free version and RoHS compliant
- ◇ Green compound (Halogen free) with suffix "G" on packing code and prefix "G" on date code

#### Mechanical Data

- ◇ Case :SOT-23 small outline plastic package
- ◇ Terminal: Matte tin plated, lead free., solderable per MIL-STD-202, Method 208 guaranteed
- ◇ High temperature soldering guaranteed: 260°C/10s
- ◇ Weight : 0.008gram (approximately)
- ◇ Marking Code : KL1,KL2,KL3,KL4

#### Pin Configuration

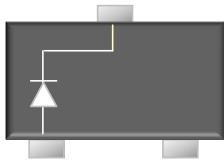

**BAT54**

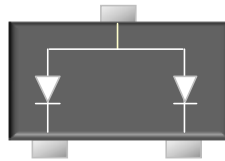

**BAT54A**

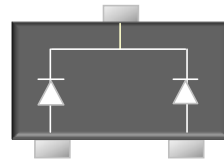

**BAT54C**

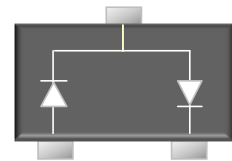

**BAT54S**

#### Ordering Information

Package	Part No.	Packing	Marking
SOT-23	BAT54 RF	3K / 7" Reel	KL1
SOT-23	BAT54A RF	3K / 7" Reel	KL2
SOT-23	BAT54C RF	3K / 7" Reel	KL3
SOT-23	BAT54S RF	3K / 7" Reel	KL4
SOT-23	BAT54 RFG	3K / 7" Reel	KL1
SOT-23	BAT54A RFG	3K / 7" Reel	KL2
SOT-23	BAT54C RFG	3K / 7" Reel	KL3
SOT-23	BAT54S RFG	3K / 7" Reel	KL4

#### Maximum Ratings and Electrical Characteristics

Rating at 25°C ambient temperature unless otherwise specified.

#### Maximum Ratings

Type Number	Symbol	Value	Units
Peak Repetitive Peak reverse voltage	$V_{RRM}$	30	V
Working Peak Reverse Voltage	$V_{RWM}$		
DC Reverse Voltage	$V_R$		
Forward Continuous Current	$I_F$	200	mA
Repetitive Peak Forward Current	$I_{FRM}$	200	mA
Forward surge current @t<1.0s	$I_{FSM}$	600	mA
Power Dissipation	$P_d$	200	mW
Thermal resistance, junction to ambient air	$R_{\theta JA}$	500	°C/W
Operating and Storage temperature	$T_j, T_{STG}$	-55 to 150	°C

#### SOT-23

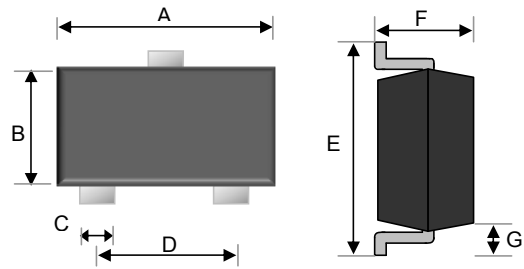

Dimensions	Unit (mm)		Unit (inch)	
	Min	Max	Min	Max
A	2.80	3.00	0.110	0.118
B	1.20	1.40	0.047	0.055
C	0.30	0.50	0.012	0.020
D	1.80	2.00	0.071	0.079
E	2.25	2.55	0.089	0.100
F	0.90	1.20	0.035	0.043
G	0.550 REF		0.022 REF	

#### Suggested PAD Layout

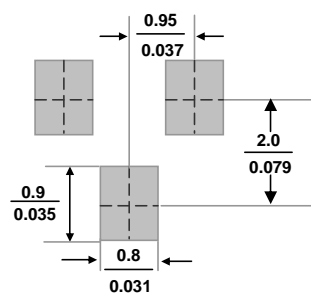

**Small Signal Diode**

**Electrical Characteristics**

Type Number		Symbol	Min	Max	Units
Reverse Breakdown Voltage	$I_R = 100\mu A$	$V_{(BR)}$	30	--	V
Forward Voltage	$I_F = 0.1mA$	$V_F$	--	0.24	V
	$I_F = 1mA$		--	0.32	V
	$I_F = 10mA$		--	0.40	V
	$I_F = 30mA$		--	0.50	V
	$I_F = 100mA$		--	1.00	V
Reverse current	$V_R = 25V$	$I_R$	--	2.0	$\mu A$
Total Capacitance	$V_R = 1V, f = 1.0MHz$	$C_T$	--	10	pF
Reverse Recovery Time	$I_F = I_R = 10mA, R_L = 100\Omega, I_{RR} = 1mA$	$t_{rr}$	--	5.0	nS

**Tape & Reel specification**

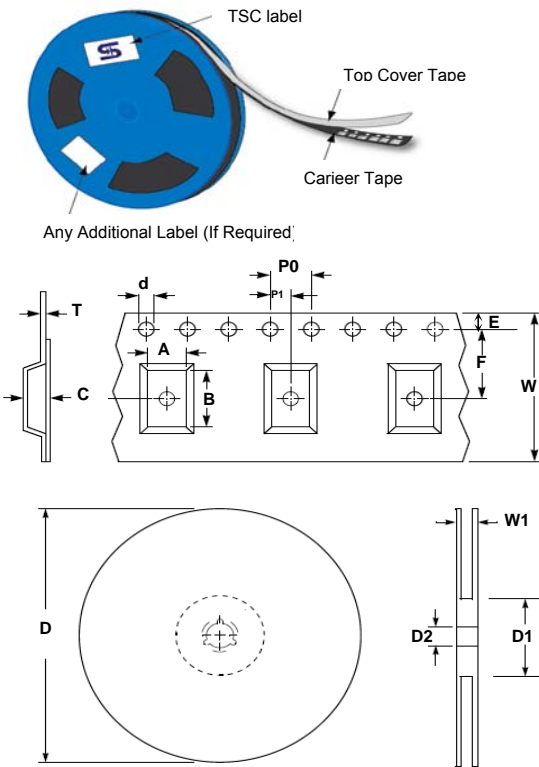

Item	Symbol	Dimension(mm)
Carrier width	A	3.15 ±0.10
Carrier length	B	2.77 ±0.10
Carrier depth	C	1.22 ±0.10
Sprocket hole	d	1.50 ± 0.10
Reel outside diameter	D	178 ± 1
Reel inner diameter	D1	55 Min
Feed hole width	D2	13.0 ± 0.20
Sprocket hole position	E	1.75 ±0.10
Punch hole position	F	3.50 ±0.05
Sprocket hole pitch	P0	4.00 ±0.10
Embossment center	P1	2.00 ±0.05
Overall tape thickness	T	0.229 ±0.013
Tape width	W	8.10 ±0.20
Reel width	W1	12.30 ±0.20

**Small Signal Diode**

**Rating and Characteristic Curves**

**FIG 1 Typical Forward Characteristics**

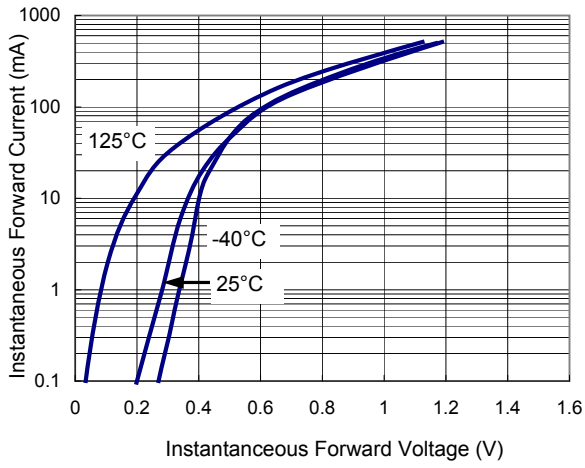

**FIG 2 Typical Reverse Characteristics**

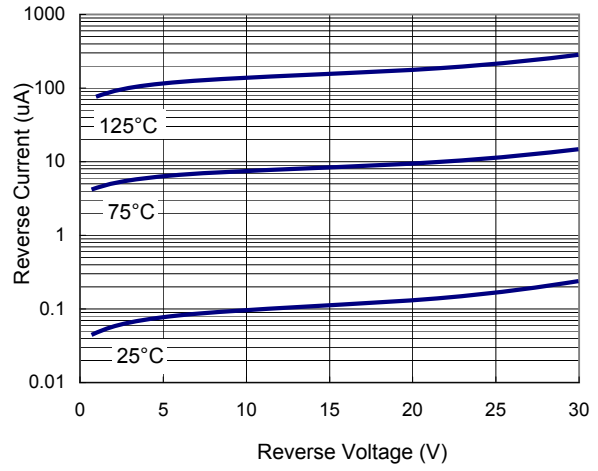

**FIG 3 Admissible Power Dissipation Curve**

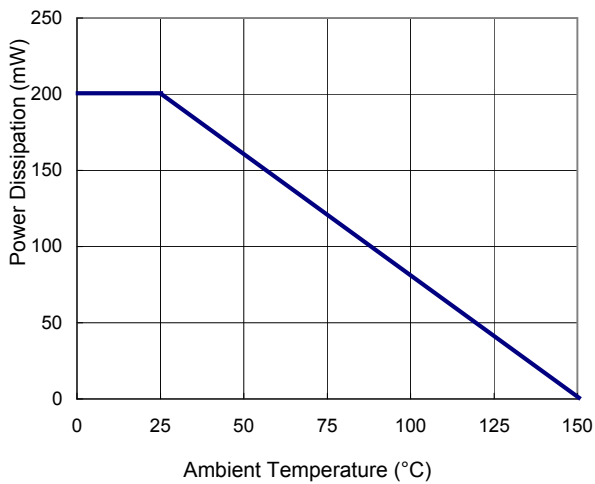

**FIG 4 Typical Junction Capacitance**

