

OY205S

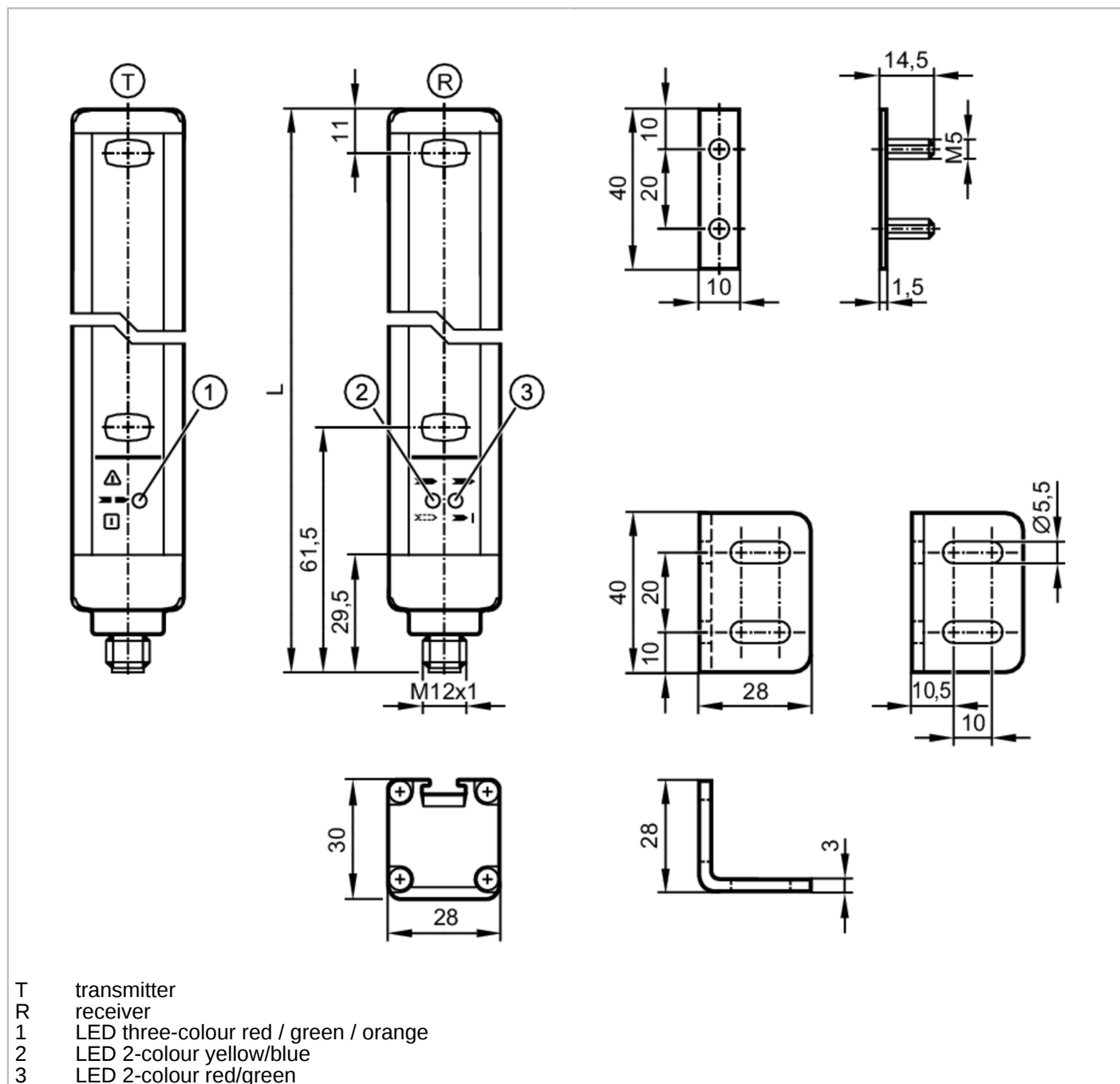

Safety light curtain

OYA0760-90-4-20-P-1



Product characteristics

| | |
|-----------------|----------------|
| Type of light | infrared light |
| Dimensions [mm] | 813 x 28 x 30 |

Application

| | |
|---------------------|---|
| Protective function | access prevention bodies or parts of bodies |
|---------------------|---|



Safety light curtain

OYA0760-90-4-20-P-1

| Electrical data | | |
|--|-------|--|
| Operating voltage tolerance | [%] | 20 |
| Operating voltage | [V] | 24 DC |
| Protection class | | III |
| Reverse polarity protection | | yes |
| Power-on delay time | [s] | < 2 |
| Type of light | | infrared light |
| Wave length | [nm] | 950 |
| Receiver | | |
| Current consumption | [mA] | 83 |
| Transmitter | | |
| Current consumption | [mA] | 42 |
| Outputs | | |
| Electrical design | | PNP |
| Number of OSSD outputs | | 2 |
| Max. current load per OSSD output | [mA] | 400; (24 V) |
| Short-circuit protection | | yes |
| Detection zone | | |
| Protected area height | [mm] | 760 |
| Resolution (detection capacity d) | [mm] | 90 |
| Protection area width (low light intensity) | [m] | 0...10 |
| Protection area width (high light intensity) | [m] | 3...20 |
| Response times | | |
| Response time | [ms] | 3.5 |
| Operating conditions | | |
| Applications | | class C to EN 60654-1 weatherproof application |
| Ambient temperature | [°C] | -10...55 |
| Max. relative air humidity | [%] | 95 |
| Protection | | IP 65; IP 67 |
| Tests / approvals | | |
| EMC | | IEC 61496-1 |
| Shock resistance | | IEC 61496-1 |
| Vibration resistance | | IEC 61496-1 |
| Safety classification | | |
| ESPE type (IEC 61496-1) | | 4 |
| ISO 13849-1 | | category 4, PL e |
| IEC 61508 | | SIL 3 |
| IEC 62061 | | SIL cl 3 |
| Mission time TM | [h] | 175200 |
| Safety-related reliability PFHD | [1/h] | 1.0E-08 |

OY205S



Safety light curtain

OYA0760-90-4-20-P-1

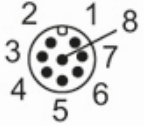
| Mechanical data | |
|--|---|
| Weight [g] | 2965 |
| Dimensions [mm] | 813 x 28 x 30 |
| Materials | housing: aluminium; front lens: PC |
| Length L [mm] | 813 |
| Displays / operating elements | |
| Display | LED, yellow |
| | LED, green |
| | LED, red |
| | LED, blue |
| | LED, orange |
| Accessories | |
| Accessories (supplied) | mounting bracket: 4 |
| | slot nuts: 4 |
| | Nuts |
| Remarks | |
| Notes | For 8-pole sockets the core colours are not standardised.; Please note the wiring of the sensor and the sockets (see data sheet). |
| Pack quantity | 1 pcs. |
| Electrical connection - receiver | |
| Connector: 1 x M12; Maximum cable length: 100 m; for wire cross-section 0.34 mm ² | |
|  | |

OY205S



Safety light curtain

OYA0760-90-4-20-P-1

Connection



Electrical connection - transmitter

Connector: 1 x M12



OY205S



Safety light curtain

OYA0760-90-4-20-P-1

Connection

