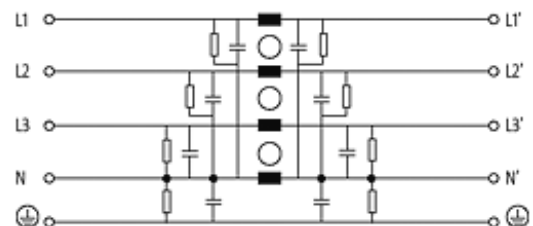

MEF EMC-FILTER 3-PHASE 1-STAGE WITH NEUTRAL

I:100A U:4x500 VAC

Current: 100 A
with neutral
with increased damping

Attenuation curves on request.

[Link to Product](#)**Illustration**

stay connected

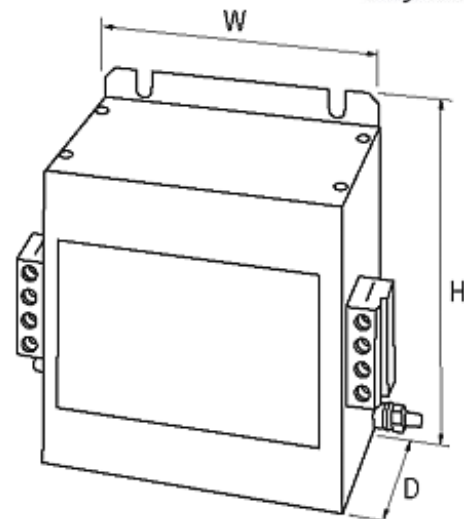

Product may differ from Image

Approvals



Technical Data

Operating voltage	max. 3 × 500 V AC
Operating frequency	50...60 Hz
Consumption at 250 V AC	max. 15 mA
Overload current	18 × (IN t) max. 0.5 ms; 1.5 × (IN t) max. 1 min. (1 × per hour)
Connection cross section	6...35 mm ² single core (AWG 9...2); 10...35 mm ² multiple core (AWG 7...2)

General data

Climatic category	25/085/21 (EN 60068-1)
Test isolation voltage	3.3 kV (L - N), 2 s; 3.1 kV (L - L), 2 s
Mounting method	screw fixing
Dimensions H × W × D	170×180×140 mm

Description

Functional description	The 3-phase and one-stage EMC filters MEF 3/1 are used in the range 0.1...30 MHz and dampen interferences found in cables from the mains, supply units and control systems. They are suitable for TN-S, TN-C-S, and TT networks. The best results are obtained
------------------------	--

Commercial data

country of origin	IT
customs tariff number	85363030
minimum order quantity	1