

SITOR FUSE-LINK 500A, AC 800V, FOR 6QG12



Figure similar

Model		
product brand name		SENTRON
Design of an identification indicator		others
Design of the fuse link		Fuses for special applications
General technical data		
Size of fuse system / acc. to DIN EN 60269-1		others
Operating class of the fuse link		aR
circuit-breaker / Design		3NE
Switching capacity		
Switching capacity current		
<ul style="list-style-type: none"> acc. to IEC 60947-2 / Rated value 	kA	100
Dissipation		
Active power loss		
<ul style="list-style-type: none"> for rated value of the current / with AC / in hot operating state / per pole 	W	155
Electricity		
rated current I_n / IEC, DIN/VDE / at 40 Cel	A	500
Current / with AC / Rated value	A	500
Mechanical Design		
mounting position		Any, preferably vertical
Environmental conditions		
Ambient temperature		
<ul style="list-style-type: none"> minimum 	°C	-20

• maximum

°C 50

Certificates

Equipment marking

- acc. to DIN EN 61346-2
- acc. to DIN EN 81346-2

F
F

General Product Approval

Declaration of Conformity



Further information

Information- and Downloadcenter (Catalogs, Brochures,...)

<http://www.siemens.com/lowvoltage/catalogs>

Industry Mall (Online ordering system)

<https://eb.automation.siemens.com/mall/en/WW/Catalog/Product/3NE43346B>

Service&Support (Manuals, Certificates, Characteristics, FAQs,...)

<http://support.automation.siemens.com/WW/view/en/3NE43346B/all>

Image database (product images, 2D dimension drawings, 3D models, device circuit diagrams, ...)

http://www.automation.siemens.com/bilddb/cax_en.aspx?mfb=3NE43346B

CAX-Online-Generator

<http://www.siemens.com/cax>

Tender specifications

<http://ausschreibungstexte.siemens.com/tiplv>

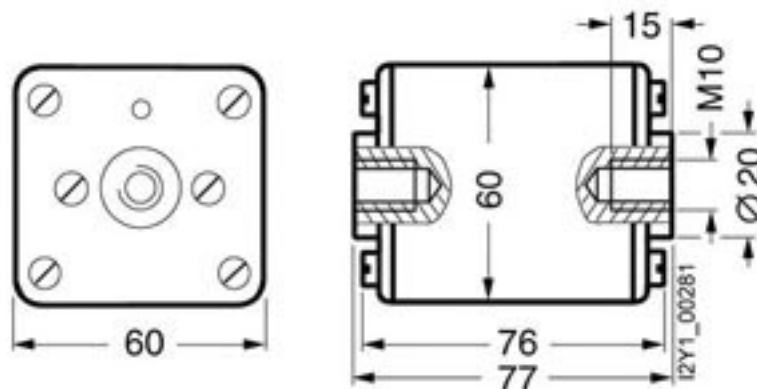

last modified:

11.03.2015