



Directional control valves

Flexflow Series

According to ISO 5599/1, size 1-4

Catalogue 9127007622GB-ul

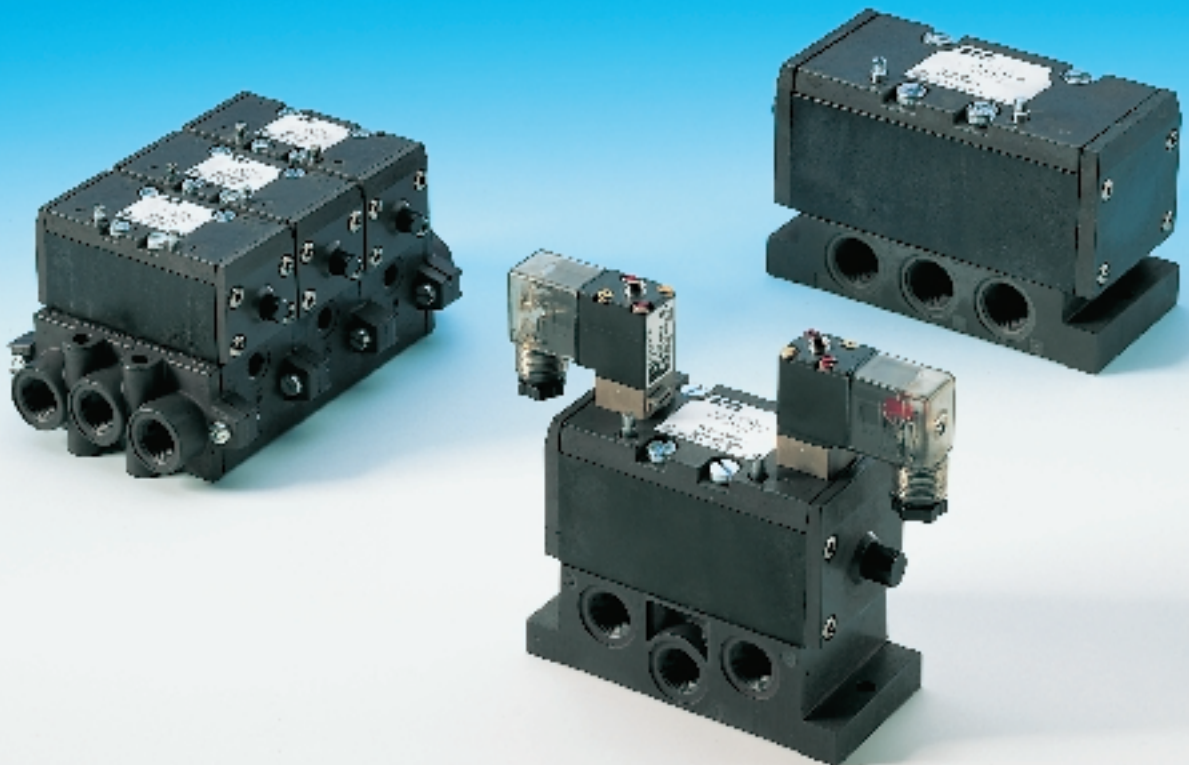

Contents

General

Flexflow, sizes 1-3	4
Flexflow, size 4	5

Flexflow, sizes 1-3

Multiple installation	6-7
Common data, ordering key	8
Pneumatically actuated 5/2 and 5/3 valves	9
Electrically actuated 5/2 and 5/3 valves	10-11
Electrically actuated 5/2 and 5/3 valves, CNOMO	12-13
Complete valves	16-18

Flexflow, size 4

Common data, ordering key	14
Handlever operated 5/2 and 5/3 valves	15
Pneumatically actuated 5/2 and 5/3 valves	15
Electrically actuated 5/2 and 5/3 valves	15

Complete valves

ISO size 1	16
ISO size 2	17
ISO size 3	18

Accessories

Solenoid valves	19
Cable heads	19
Electric installation	20
Valvetronic 110	21
Cable heads with cable	22
Extension cables	22
Manifolds, ISO-1	23-24
Manifolds, ISO-2	25-26
Manifolds, ISO-3	25
Manifolds, ISO-4	26

Dimensions

Flexflow, size 1	27
Flexflow, size 2	28
Flexflow, size 3	29-30
Flexflow, size 4	31
Manifolds, ISO-1 - ISO-3	32-34
Manifolds, ISO-4	35



Important!

Before carrying out any service work, ensure that the valve and manifold have been vented. Remove the primary supply air hose to ensure total disconnection of the air supply before dismantling valves or blind connection blocks.



Note!

All technical data in this catalogue is typical only. The air quality is decisive for the valve life: see ISO 8573.

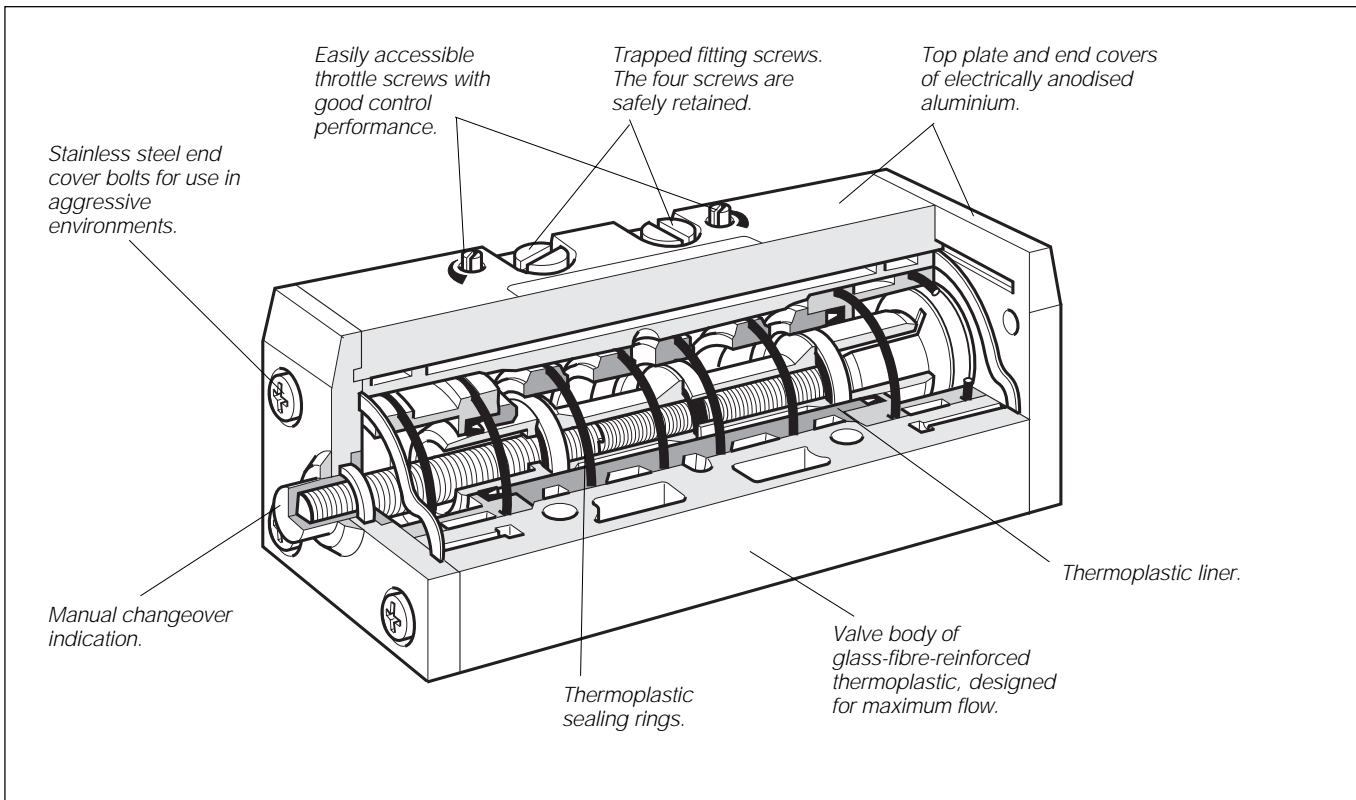

Valve range

VG25, G1/4, ISO 5599/1, size 1

VG35, G3/8, ISO 5599/1, size 2

VG45, G1/2, ISO 5599/1, size 3

The VG valve range consists of 5-port working valves, conforming to ISO 5599/1, sizes 1, 2 and 3. The valves feature small dimensions and high performance for applications where high flow rates are required.

The range includes both 5/2 and 5/3 valves, for pneumatic or Electric operation. Two types of electrically operated pilot valves are available: the compact VE03 or the VG13 in accordance with CNOMO.

Three different manifold systems are available for the VG25 range: a compact ISO manifold, an ISO and VDMA 24345 manifold and a side-connection ISO manifold. For the VG35, there are ISO and VDMA manifolds and a side-connection ISO manifold, while for the VG45 there are ISO and VDMA manifolds.

International standard

The VG25, VG35 and VG45 are all fully interchangeable, in accordance with ISO 5599/1. The range includes electrically-operated valves for use as pilot valves that comply with the French CNOMO standard, and there are also standardised manifolds that comply with the German VDMA 24345.

Compact, corrosion-resistant design

The valves combine high flow capacity with small size, while the smooth shape meets high hygiene requirements. Electrically anodised aluminium and stainless steel end cover bolts mean that the valves are suited for use in difficult environments as standard.

High flow capacity

The design principle - of a round spool and an injection-moulded thermoplastic valve body - has made it possible to provide large flow areas for maximum flow capacity.

Lubrication and maintenance-free for long life

The use of high-molecular plastic with inherent lubricating properties means that the VG25, VG35 and VG45 are suitable for use with or without additional lubrication. In addition, the design principle ensures many years of reliable operation.

Manual changeover - indication

Commissioning and service are assisted by the incorporation of large, ergonomically designed pushbuttons for manual changeover as standard in all the valves in the range. This also makes it easy to see the position of the valve spools when fault-tracing.

Integral speed control

Ports 3 and 5 incorporate throttle screws for control of cylinder operation speeds. The screws are accessibly mounted on the top of the valves. A wide control range in several steps ensures excellent speed control of both large and small cylinders,

Common multiple mounting:

VG25-VG35 and VG25-VG45

The use of adapter connectors between multiple manifolds for the different valve sizes makes it easy to assemble different valve sizes into a single valve block.

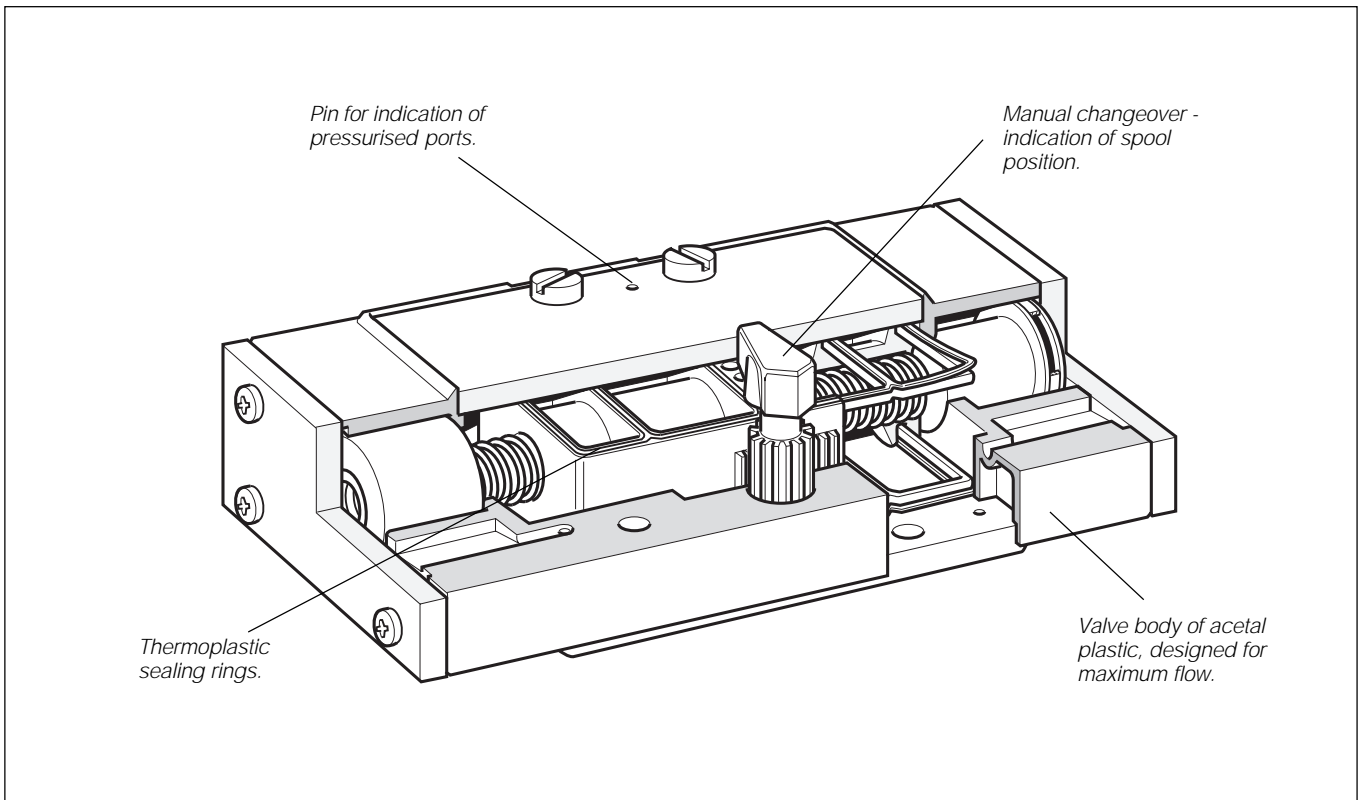

Valve range

VE45, G1/2 and G3/4, ISO 5599/1, size 4

The VE45 valve range consists of 5-port working valves, conforming to ISO 5599/1, size 4. The range includes both 5/2 and 5/3 valves, for pneumatic or Electric operation: both types can also be manually operated. Electrically operated pilot valves are from the VE13 range.

Manifolds are available as single manifolds and as two sizes of multiple mounting manifolds, for G1/2 and G3/4.

International standard

VE45 valves are fully interchangeable, in accordance with ISO 5599/1. In addition, G3/4 manifolds comply with the German VDMA 24345 standard.

Lubrication and maintenance-free for long life

The valves have a flat, symmetrical plastic spool, pressure-relieved and mounted between slider surfaces, ensuring certainty of operation and reliable starting even after long periods at rest. The sliding lubricant-loaded plastic seal reduces friction and eliminates the need for additional lubrication. This, coupled with the choice of materials, ensures a long life and reliable operation.

High flow capacity

The flat spool ensures minimum pressure loss, whether operating with compressed air or vacuum.

Manual changeover - indication

Commissioning and service are assisted by the ability to operate the valve manually by means of a knob. The position of the knob also indicates the position of the spool.

An indication pin shows which ports are pressurised.

Speed control

As standard, the compact G1/2 manifold incorporates easily accessible throttle valves in the exhaust ports. The G3/4 manifold conforms to VDMA 24345 and is designed for maximum flow rate.

Solenoid valves



Solenoid valves and cable heads must be ordered separately. Use the VE13-E-S-6 as a pilot valve for the valves in this range. A pilot valve is required for each E in the valve order code. VE13 valves are available in standard (8 W) and low-power (2 W) versions.

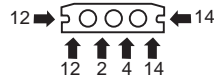
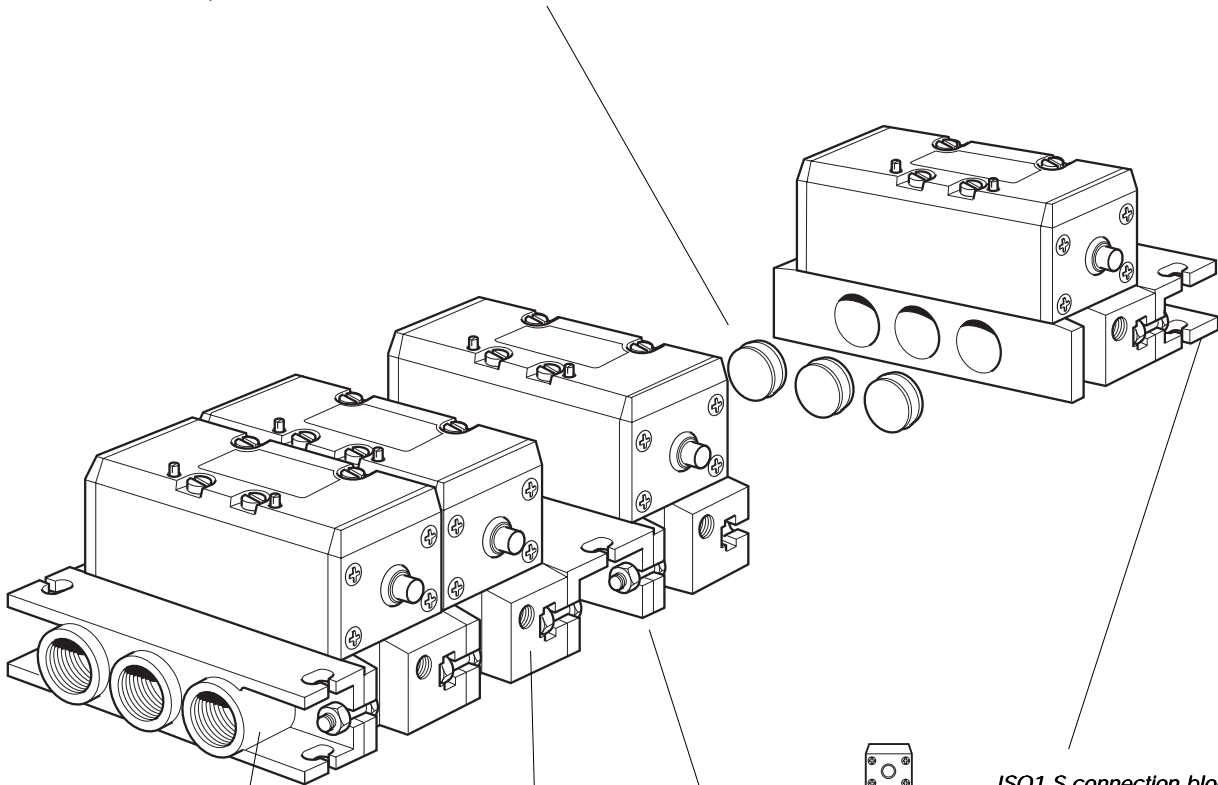
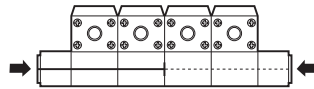

Flexible multi-mounting, VG25

Isolation plugs
enable the use of two separate primary pressures in the same compact block.

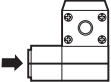
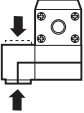

ISO1-M multiple manifold.
Parts 2 and 4 are connected from the bottom. Parts 12 and 14 can be connected from the side or from the bottom.

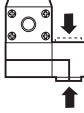
-  **ISO1-S connection block,**
for side connection
-  **ISO1-L connection block,**
for top or bottom connection
-  **ISO1-M end block.**

-  **ISO1-S connection block,**
for side connection
-  **ISO1-L connection block,**
for top or bottom connection
-  **ISO1-M end block.**

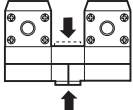
 **ISO1-T connection block**
for connection to the centre of the valve block. Top or bottom connection.

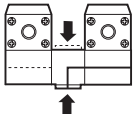
 **ISO1-L connection block**
for connection of separate primary supplies to the next valve block. Top or bottom connection.

**Multiple mounting with bottom connection
VG25, VG35 and VG45 to VDMA 24345**

**Multiple mounting with side connection
VG25 and VG35 to VDMA 24345**

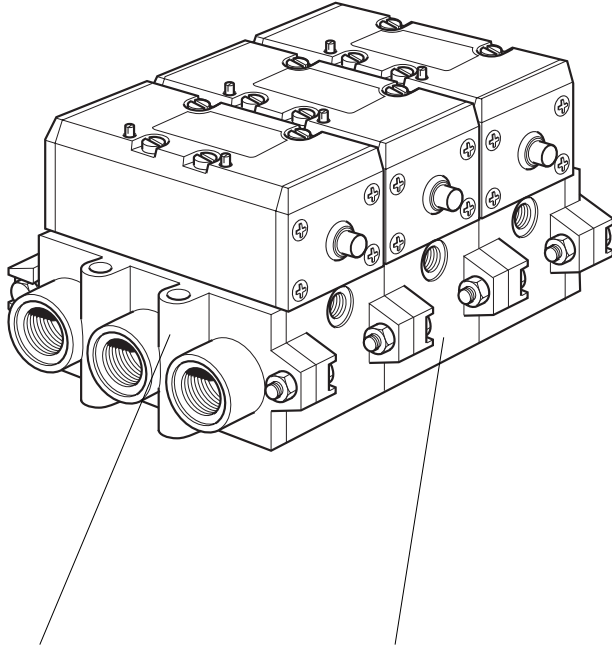

ISO-D connection set
for side connection*

ISO-C multiple manifold
Ports 2 and 4 connected
from the bottom:
ports 12 and 14 connected
from the side.*

*
1 for VG25
2 for VG35
3 for VG45

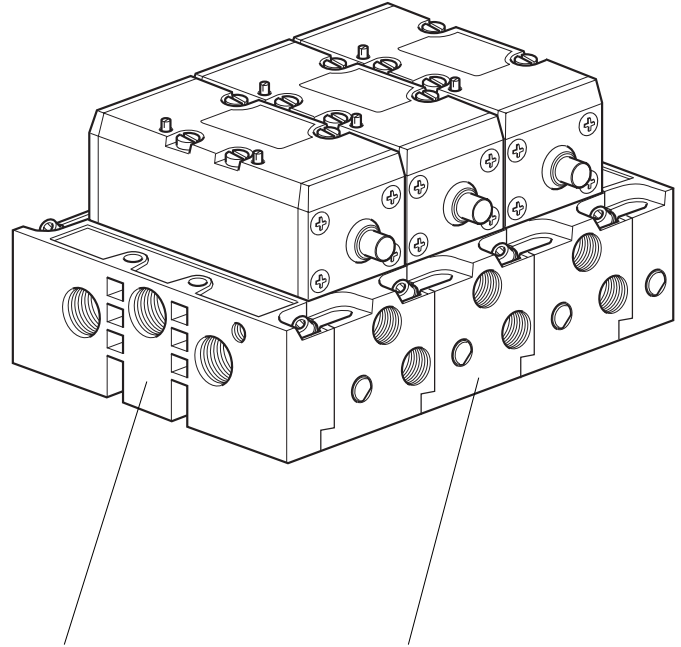

*Connection set
P2N-EM513ES (VG25)
P2N-FM514ES (VG35)
For side connection*

*Multiple manifold
P2N-EM512MD (VG25)
P2N-FM513MD (VG35)
Ports 2 and 4, as well as 12
and 14, connected from the
side.*

Throttle inserts

Fitting throttle inserts in exhaust ports 3 and 5 provides several stages of cylinder speed control.

Valve	Throttle insert	Flow as % of maximum flow
VG25	With throttle insert	0-60%
	Without throttle insert	-100%
VG35, VG45	With whole throttle insert	0-50%
	With half throttle insert	-80%
	Without throttle insert	-100%

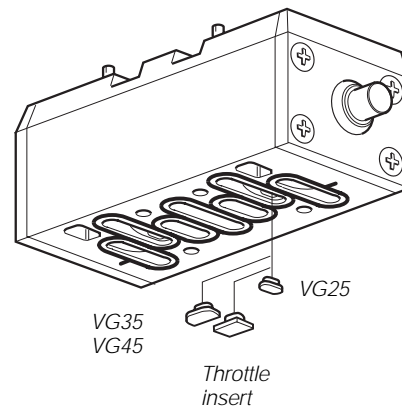

*NB:
The throttle
inserts must be
removed for
maximum flow
capacity.*

- High flow rates, rapid changeover
- Compact, corrosion-resistant low-weight design
- Integral speed control
- Manual spool changeover
- Wide range of manifolds (low-profile and VDMA)

Material specification

Valve body	Acetal plastic
Spool	Acetal plastic
Spool seal	High-molecular thermoplastic
U-rings, O-rings	Nitrile rubber, NBR
Sleeves	Thermoplastic
Piston	Acetal plastic
End covers	Electrically anodised aluminium
Top plate	Electrically anodised aluminium
End seals	Nitrile rubber, NBR
Seal, top plate	Nitrile rubber, NBR
Manual changeover pushbutton	Acetal plastic
Throttle screws	Galvanised brass
Throttle inserts	Acetal plastic
End cover bolts	Stainless steel
Mounting screws	Galvanised steel (standard)
Mounting screws	Stainless steel (accessories)
Manifolds	Electrically anodised aluminium

Flow characteristic

Flow capacity to ISO 6358. All pressures = effective pressure

VG25

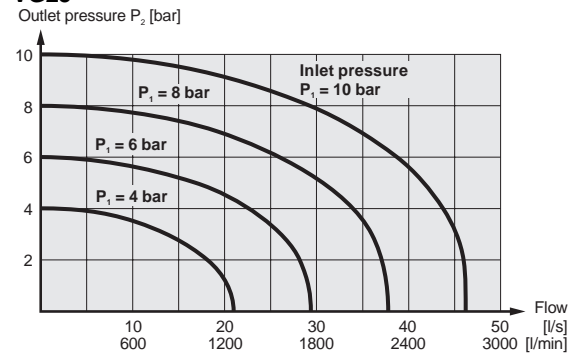

VG35

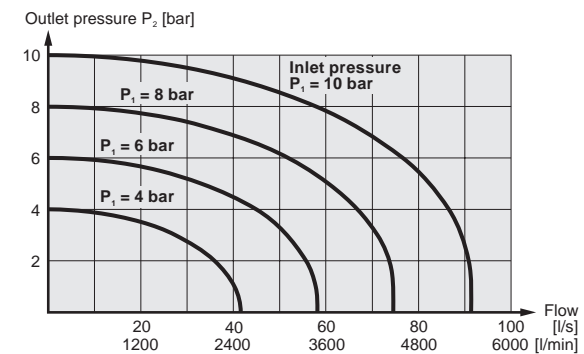



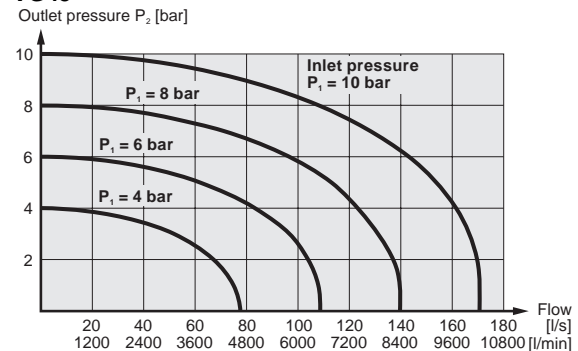







VG45



Ordering key

VG25-	A	X	ERER	2	C	Q	
ISO size	Centre position	Actuator / return	Voltage	Connector			
VG25- ISO size 1	Closed	AA External air	C 24 V	None			
VG35- ISO size 2	X Vented	AS External air/Spring	E 110 V	Q Connector with LED + VDR or diode			
VG45- ISO size 3	Y Pressurised	AC External air, self-centring	H 220 V				
	Z Closed/pressurised	ERS Electric, internal air/Spring	K 240 V				
	Solenoid	ERDR Electric, internal air/Differential air return					
	Mini solenoid	ERER Electric, internal air					
A CNOMO solenoid		ERC Electric, internal air, self-centring	Current				
		EAS Electric, external air/Spring	2 DC	Possible combinations: see pages 9 - 13.			
		EAEA Electric, external air	4 50/60 Hz				
		EAC Electric, external air, self-centring					

Data	VG25	VG35	VG45
Dimension	ISO 1	ISO 2	ISO 3
Operating pressure, max	10 bar	10 bar	10 bar
Operating temperature	-20 to +70 °C	-20 to +70 °C	-20 to +70 °C
Flow (acc. to ISO 6358)	C=4,2 NI/s x bar b=0,2 Qn=17 l/s Qmax=29,4 l/s Cv=1,04	C=8,3 NI/s x bar b=0,2 Qn=33 l/s Qmax=58,0 l/s Cv=2,02	C=15,5 NI/s x bar b=0,2 Qn=62 l/s Qmax=108,5 l/s Cv=3,80

	Symbol	ISO size	Actuator	Return	Signal pressure min, bar at 6 bar activ./return	Changeover time, ms at 6 bar activ./return	Port nominal size	Weight Kg	Order code
Pneumatically actuated 5/2 and 5/3 valves									
		1	Air signal	Air signal	1,5/1,5	10/10	G1/4	0,26	VG25-AA
		2			1,5/1,5	12/12	G3/8	0,48	VG35-AA
		3			1,5/1,5	15/15	G1/2	0,95	VG45-AA
		1	Air signal	Spring	3,5/-	15/25	G1/4	0,26	VG25-AS
		2			3,5/-	17/35	G3/8	0,48	VG35-AS
		3			3,5/-	20/45	G1/2	0,95	VG45-AS
		1	Air signal closed centre position	Air signal self-centring	3,5/3,5	15/20	G1/4	0,26	VG25-AC
		2			3,5/3,5	17/28	G3/8	0,48	VG35-AC
		3			3,5/3,5	18/35	G1/2	0,95	VG45-AC
		1	Air signal vented centre position	Air signal self-centring	3,5/3,5	15/20	G1/4	0,26	VG25-XAC
		2			3,5/3,5	17/28	G3/8	0,48	VG35-XAC
		3			3,5/3,5	18/35	G1/2	0,95	VG45-XAC
		1	Air signal pressurised centre position	Air signal self-centring	3,5/3,5	15/20	G1/4	0,26	VG25-YAC
		2			3,5/3,5	17/28	G3/8	0,48	VG35-YAC

Manifolds must be ordered separately: see pages 23-26.
Dimensions: see pages 27-30.

Data	VG25	VG35	VG45
Dimension	ISO 1	ISO 2	ISO 3
Operating pressure, max	10 bar	10 bar	10 bar
Operating temperature	-20 to +70 °C	-20 to +70 °C	-20 to +70 °C
Flow (acc. to ISO 6358)	C=4,2 NI/s x bar b=0,2 Qn=17 l/s Qmax=29,4 l/s Cv=1,04	C=8,3 NI/s x bar b=0,2 Qn=33 l/s Qmax=58,0 l/s Cv=2,02	C=15,5 NI/s x bar b=0,2 Qn=62 l/s Qmax=108,5 l/s Cv=3,80

Symbol	ISO size	Actuator	Return	Signal pressure min, bar at 6 bar activ./return	Changeover time, ms at 6 bar activ./return	Port nominal size	Weight Kg	Order code
--------	----------	----------	--------	---	--	-------------------	-----------	------------

Electrically actuated 5/2 and 5/3 valves

Internal air supply to solenoid valve(s) via port 1 for VE03 miniature solenoid valve.











		1	Electric	Spring	3,5/-	15/25	G1/4	0,26	VG25-ERS
		2			3,5/-	28/58	G3/8	0,48	VG35-ERS
		3			3,5/-	40/90	G1/2	0,95	VG45-ERS
		1	Electric	Differential air signal	3,5/-	15/25	G1/4	0,26	VG25-ERDR
		2			3,5/-	28/58	G3/8	0,48	VG35-ERDR
		1	Electric	Electric	1,5/1,5	15/15	G1/4	0,26	VG25-ERER
		2			1,5/1,5	22/22	G3/8	0,48	VG35-ERER
		3			1,5/1,5	28/28	G1/2	0,95	VG45-ERER
		1	Electric closed centre position	Electric self-centring	3,5/-	25/30	G1/4	0,26	VG25-ERC
		2			3,5/-	38/65	G3/8	0,48	VG35-ERC
		3			3,5/-	50/100	G1/2	0,95	VG45-ERC
		1	Electric vented centre position	Electric self-centring	3,5/-	25/30	G1/4	0,26	VG25-XERC
		2			3,5/-	38/65	G3/8	0,48	VG35-XERC
		3			3,5/-	50/100	G1/2	0,95	VG45-XERC
		1	Electric pressurised centre position	Electric self-centring	3,5/-	25/30	G1/4	0,26	VG25-YERC
		2			3,5/-	38/65	G3/8	0,48	VG35-YERC
		1	Electric pressurised/ closed centre position	Electric self-centring	3,5/-	25/30	G1/4	0,26	VG25-ZERC
		2			3,5/-	38/65	G3/8	0,48	VG35-ZERC
		3			3,5/-	50/100	G1/2	0,95	VG45-ZERC

Data	VG25	VG35	VG45
Dimension	ISO 1	ISO 2	ISO 3
Operating pressure, max	10 bar	10 bar	10 bar
Operating temperature	-20 to +70 °C	-20 to +70 °C	-20 to +70 °C
Flow (acc. to ISO 6358)	C=4,2 NI/s x bar b=0,2 Qn=17 l/s Qmax=29,4 l/s Cv=1,04	C=8,3 NI/s x bar b=0,2 Qn=33 l/s Qmax=58,0 l/s Cv=2,02	C=15,5 NI/s x bar b=0,2 Qn=62 l/s Qmax=108,5 l/s Cv=3,80

Symbol	ISO size	Actuator	Return	Signal pressure min, bar at 6 bar activ./return	Changeover time, ms at 6 bar activ./return	Port nominal size	Weight Kg	Order code
--------	----------	----------	--------	---	--	-------------------	-----------	------------

Electrically actuated 5/2 and 5/3 valves

External air supply to solenoid valve(s) via port 14, or ports 14 and 12, for VE03 miniature solenoid valve.

		1	Electric	Spring	3,5/-	15/25	G1/4	0,26	VG25-EAS
		2			3,5/-	28/58	G3/8	0,48	VG35-EAS
		3			3,5/-	40/90	G1/2	0,95	VG45-EAS
		1	Electric	Electric	1,5/1,5	15/15	G1/4	0,26	VG25-EAEA
		2			1,5/1,5	22/22	G3/8	0,48	VG35-EAEA
		3			1,5/1,5	28/28	G1/2	0,95	VG45-EAEA
		1	Electric closed centre position	Electric self-centring	3,5/-	25/30	G1/4	0,26	VG25-EAC
		2			3,5/-	38/65	G3/8	0,48	VG35-EAC
		1	Electric vented centre position	Electric self-centring	3,5/-	25/30	G1/4	0,26	VG25-XEAC
		2			3,5/-	38/65	G3/8	0,48	VG35-XEAC
		1	Electric pressurised/ closed centre position	Electric self-centring	3,5/-	25/30	G1/4	0,26	VG25-ZEAC
		2			3,5/-	38/65	G3/8	0,48	VG35-ZEAC
		3			3,5/-	50/100	G1/2	0,95	VG45-ZEAC









Solenoid valves must be ordered separately: see page 19.
Manifolds must be ordered separately: see pages 23-26.
Complete valves: see pages 16-18.
Dimensions: see pages 27-30.

Data	VG25	VG35	VG45
Dimension	ISO 1	ISO 2	ISO 3
Operating pressure, max	10 bar	10 bar	10 bar
Operating temperature	-20 to +70 °C	-20 to +70 °C	-20 to +70 °C
Flow (acc. to ISO 6358)	C=4,2 NI/s x bar b=0,2 Qn=17 l/s Qmax=29,4 l/s Cv=1,04	C=8,3 NI/s x bar b=0,2 Qn=33 l/s Qmax=58,0 l/s Cv=2,02	C=15,5 NI/s x bar b=0,2 Qn=62 l/s Qmax=108,5 l/s Cv=3,80

Symbol	ISO size	Actuator	Return	Signal pressure min, bar at 6 bar activ./return	Changeover time, ms at 6 bar activ./return	Port nominal size	Weight Kg	Order code
--------	----------	----------	--------	---	--	-------------------	-----------	------------

Electrically actuated 5/2 and 5/3 valves

Internal air supply to solenoid valve(s) via port 1 for VG13 CNOMO solenoid valve.

		1	Electric	Spring	3,5/-	15/15	G1/4	0,26	VG25-AERS
		2			3,5/-	22/22	G3/8	0,48	VG35-AERS
		3			3,5/-	40/90	G1/2	0,95	VG45-AERS
		1	Electric	Electric	1,5/1,5	15/15	G1/4	0,26	VG25-AERER
		2			1,5/1,5	22/22	G3/8	0,48	VG35-AERER
		3			1,5/1,5	28/28	G1/2	0,95	VG45-AERER
		1	Electric closed centre position	Electric self-centring	3,5/-	25/30	G1/4	0,26	VG25-AERC
		2			3,5/-	38/65	G3/8	0,48	VG35-AERC
		3			3,5/-	50/100	G1/2	0,95	VG45-AERC
		1	Electric vented centre position	Electric self-centring	3,5/-	25/30	G1/4	0,25	VG25-AXERC
		2			3,5/-	38/65	G3/8	0,48	VG35-AXERC
		3			3,5/-	50/100	G1/2	0,95	VG45-AXERC









Solenoid valves must be ordered separately: see page 19.
Manifolds must be ordered separately: see pages 23-26.
Complete valves: see pages 16-18.
Dimensions: see pages 27-30.

Data	VG25	VG35	VG45
Dimension	ISO 1	ISO 2	ISO 3
Operating pressure, max	10 bar	10 bar	10 bar
Operating temperature	-20 to +70 °C	-20 to +70 °C	-20 to +70 °C
Flow (acc. to ISO 6358)	C=4,2 NI/s x bar b=0,2 Qn=17 l/s Qmax=29,4 l/s Cv=1,04	C=8,3 NI/s x bar b=0,2 Qn=33 l/s Qmax=58,0 l/s Cv=2,02	C=15,5 NI/s x bar b=0,2 Qn=62 l/s Qmax=108,5 l/s Cv=3,80

Symbol	ISO size	Actuator	Return	Signal pressure min, bar at 6 bar activ./return	Changeover time, ms at 6 bar activ./return	Port nominal size	Weight Kg	Order code
--------	----------	----------	--------	---	--	-------------------	-----------	------------

Electrically actuated 5/2 and 5/3 valves

External air supply to solenoid valve(s) via port 14, or ports 14 and 12, for VG13 CNOMO solenoid valve.

		1	Electric	Spring	3,5/-	15/15	G1/4	0,26	VG25-AEAS
		2			3,5/-	22/22	G3/8	0,48	VG35-AEAS
		3			3,5/-	40/90	G1/2	0,95	VG45-AEAS
		1	Electric	Electric	1,5/1,5	15/15	G1/4	0,26	VG25-AEAEA
		2			1,5/1,5	22/22	G3/8	0,48	VG35-AEAEA
		3			1,5/1,5	28/28	G1/2	0,95	VG45-AEAEA
		1	Electric closed centre position	Electric self-centring	3,5/-	25/30	G1/4	0,25	VG25-AEAC
		2			3,5/-	38/65	G3/8	0,48	VG35-AEAC
		1	Electric vented centre position	Electric self-centring	3,5/-	25/30	G1/4	0,25	VG25-AXEAC
		2			3,5/-	25/30	G3/8	0,48	VG35-AXEAC

Solenoid valves must be ordered separately: see page 19.
 Manifolds must be ordered separately: see pages 23-26.
 Complete valves: see pages 16-18.
 Dimensions: see pages 27-30.

- Manual changeover and indication of the spool position.
- Indicator pin shows pressurised port to facilitate system fault-tracing.
- Throttle inserts in manifolds for simple speed control.
- Patented flat spool.

Material specification

Valve body	Acetal plastic
Spool	Acetal plastic
Spool seal	High-molecular thermoplastic
O-rings	Nitrile rubber, NBR
Flat spool	Glass-fibre-reinforced thermoplastic
Springs	Stainless steel
Indicator	Electrically anodised aluminium
Mounting screws	Galvanised steel
Throttle inserts	Galvanised steel
Manifolds	Electrically anodised aluminium
End covers and top plate	Electrically anodised aluminium
Hand lever	Galvanised steel

Flow characteristic

Flow capacity to ISO 6358
All pressures = effective pressure

VG45

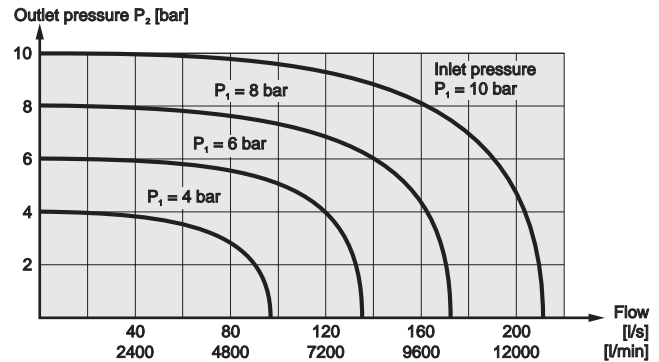









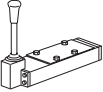

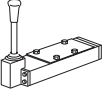

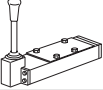
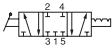
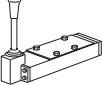
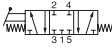
Solenoid valves must be ordered separately: see page 19.
Manifolds must be ordered separately: see pages 26.
Dimensions: see page 31.

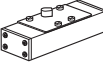
Ordering key

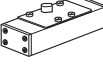
VE45-		X	ERER		2	C	Q																								
<table border="1"> <tr><th>ISO size</th></tr> <tr><td>ISO size 4</td></tr> </table>		ISO size	ISO size 4	<table border="1"> <tr><th>Mittläge</th></tr> <tr><td>Closed</td></tr> <tr><td>X Vented</td></tr> <tr><td>Y Pressurised</td></tr> </table>	Mittläge	Closed	X Vented	Y Pressurised	<table border="1"> <tr><th>Actuator / return</th></tr> <tr><td>HS Hand lever/Spring</td></tr> <tr><td>HL2 Hand lever, 2 positions</td></tr> <tr><td>HB3 Hand lever, lockable 3 positions</td></tr> <tr><td>HC Hand lever, self-centring</td></tr> <tr><td>AA External air</td></tr> <tr><td>AS External air/Spring</td></tr> <tr><td>AC External air, self-centring</td></tr> <tr><td>ERS Electric, internal air/Spring</td></tr> <tr><td>ERER Electric, internal air</td></tr> <tr><td>ERC Electric, internal air self-centring</td></tr> </table>		Actuator / return	HS Hand lever/Spring	HL2 Hand lever, 2 positions	HB3 Hand lever, lockable 3 positions	HC Hand lever, self-centring	AA External air	AS External air/Spring	AC External air, self-centring	ERS Electric, internal air/Spring	ERER Electric, internal air	ERC Electric, internal air self-centring	<table border="1"> <tr><th>Voltage</th></tr> <tr><td>C 24 V</td></tr> <tr><td>E 110 V</td></tr> <tr><td>H 220 V</td></tr> <tr><td>K 240 V</td></tr> </table>	Voltage	C 24 V	E 110 V	H 220 V	K 240 V	<table border="1"> <tr><th>Connector</th></tr> <tr><td>None</td></tr> <tr><td>Q Connector with LED + VDR or diode</td></tr> </table>	Connector	None	Q Connector with LED + VDR or diode
ISO size																															
ISO size 4																															
Mittläge																															
Closed																															
X Vented																															
Y Pressurised																															
Actuator / return																															
HS Hand lever/Spring																															
HL2 Hand lever, 2 positions																															
HB3 Hand lever, lockable 3 positions																															
HC Hand lever, self-centring																															
AA External air																															
AS External air/Spring																															
AC External air, self-centring																															
ERS Electric, internal air/Spring																															
ERER Electric, internal air																															
ERC Electric, internal air self-centring																															
Voltage																															
C 24 V																															
E 110 V																															
H 220 V																															
K 240 V																															
Connector																															
None																															
Q Connector with LED + VDR or diode																															
				<table border="1"> <tr><th>Current</th></tr> <tr><td>2 DC</td></tr> <tr><td>4 50/60 Hz</td></tr> </table>	Current	2 DC	4 50/60 Hz	<p>Possible combinations: see page 15.</p>																							
Current																															
2 DC																															
4 50/60 Hz																															

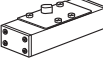



Data	VE45	Flow (to ISO 6358)	C=19,2 NI/s x bar
Dimension	ISO 4		b=0,35
Operating pressure, max	10 bar		Qn=84 l/s
Operating temperature	-20 to +70 °C		Qmax=134,4 l/s
			Cv=5,0

Symbol	ISO size	Actuator	Return	Changeover angle	Changeover force N	Port nominal size	Weight Kg	Order code
Hand lever operated 5/2 and 5/3 valves								
		4	Hand lever	Hand lever	30°	20	G1/2	1,120 VE45-HL2
		4	Hand lever	Spring	30°	60	G1/2	1,120 VE45-HS
		4	Hand lever closed centre position	Hand lever lockable 3 positions	±15°	40	G1/2	1,140 VE45-HB3
		4	Hand lever vented centre position	Hand lever self-centring	±15°	60	G1/2	1,140 VE45-HC

Symbol	ISO size	Actuator	Return	Signal pressure min, bar at 6 bar activ./return	Changeover time, ms at 6 bar activ./return	Port nominal size	Weight Kg	Order code
Pneumatically actuated 5/2 and 5/3 valves								
		4	Air signal	Air signal	2,0/2,0	20/20	G1/2	0,764 VE45-AA
		4	Air signal	Spring	3,5/-	30/45	G1/2	0,764 VE45-AS
		4	Air signal closed centre position	Air signal self-centring	3,5/3,5	30/50	G1/2	0,820 VE45-AC
		4	Air signal vented centre position	Air signal self-centring	3,5/3,5	30/50	G1/2	0,820 VE45-XAC

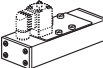
Electrically actuated 5/2 and 5/3 valves

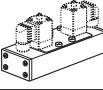
Internal air supply to solenoid valve(s) via port 1 for VE13 solenoid valve.

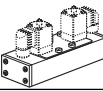
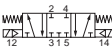
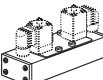
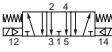
		4	Electric	Spring	3,5/-	30/60	G1/2	0,870 VE45-ERS
		4	Electric	Electric	2,0/2,0	25/25	G1/2	0,870 VE45-ERER
		4	Electric closed centre position	Electric self-centring	3,5/3,5	35/70	G1/2	0,930 VE45-ERC
		4	Electric vented centre position	Electric self-centring	3,5/3,5	35/70	G1/2	0,930 VE45-XERC

Complete valves

Complete factory-assembled valves, consisting of:
 Directional control valve
 Solenoid valve(s)
 Cable head(s)

Complete valves, ISO size 1

Without manifold

VG25-ERS

Supply voltage **Order code**

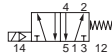

24VDC **VG25-ERS2CQ**
 Consisting of:
 1 pc Valve VG25-ERS
 1 pc Solenoid valve VE03-ESP002C2
 1 pc Cable head 24VDC, LED+diode

24V,
50/60Hz **VG25-ERS4CQ**
 Consisting of:
 1 pc Valve VG25-ERS
 1 pc Solenoid valve VE03-ESC014C2
 1 pc Cable head 24V AC/DC, LED+VDR

110V,
50/60Hz **VG25-ERS4EQ**
 Consisting of:
 1 pc Valve VG25-ERS
 1 pc Solenoid valve VE03-ESC014E2
 1 pc Cable head 110V AC/DC, LED+VDR

220V,
50/60Hz **VG25-ERS4HQ**
 Consisting of:
 1 pc Valve VG25-ERS
 1 pc Solenoid valve VE03-ESC014H2
 1 pc Cable head 220V AC/DC, LED+VDR

240V,
50/60Hz **VG25-ERS4KQ**
 Consisting of:
 1 pc Valve VG25-ERS
 1 pc Solenoid valve VE03-ESC014K2
 1 pc Cable head 240V AC/DC, LED+VDR

Complete valves, ISO size 1

Without manifold

VG25-ERER

Supply voltage **Order code**



24VDC **VG25-ERER2CQ**
 Consisting of:
 1 pc Valve VG25-ERER
 2 pcs Solenoid valves VE03-ESP002C2
 2 pcs Cable heads 24VDC, LED+diode

24V,
50/60Hz **VG25-ERER4CQ**
 Consisting of:
 1 pc Valve VG25-ERER
 2 pcs Solenoid valves VE03-ESC014C2
 2 pcs Cable heads 24V AC/DC, LED+VDR

110V,
50/60Hz **VG25-ERER4EQ**
 Consisting of:
 1 pc Valve VG25-ERER
 2 pcs Solenoid valves VE03-ESC014E2
 2 pcs Cable heads 110V AC/DC, LED+VDR

220V,
50/60Hz **VG25-ERER4HQ**
 Consisting of:
 1 pc Valve VG25-ERER
 2 pcs Solenoid valves VE03-ESC014H2
 2 pcs Cable heads 220V AC/DC, LED+VDR

240V,
50/60Hz **VG25-ERER4KQ**
 Consisting of:
 1 pc Valve VG25-ERER
 2 pcs Solenoid valves VE03-ESC014K2
 2 pcs Cable heads 240V AC/DC, LED+VDR

Complete valves

Complete factory-assembled valves, consisting of:
 Directional control valve
 Solenoid valve(s)
 Cable head(s)

Complete valves, ISO size 2

Without manifold

VG35-ERS

Supply voltage	Order code	
----------------	------------	---

24VDC	VG35-ERS2CQ Consisting of: 1 pc Valve VG35-ERS 1 pc Solenoid valve VE03-ESP002C2 1 pc Cable head 24VDC, LED+diode	
-------	--	--

24V, 50/60Hz	VG35-ERS4CQ Consisting of: 1 pc Valve VG35-ERS 1 pc Solenoid valve VE03-ESC014C2 1 pc Cable head 24V AC/DC, LED+VDR	
-----------------	--	--

110V, 50/60Hz	VG35-ERS4EQ Consisting of: 1 pc Valve VG35-ERS 1 pc Solenoid valve VE03-ESC014E2 1 pc Cable head 110V AC/DC, LED+VDR	
------------------	---	--

220V, 50/60Hz	VG35-ERS4HQ Consisting of: 1 pc Valve VG35-ERS 1 pc Solenoid valve VE03-ESC014H2 1 pc Cable head 220V AC/DC, LED+VDR	
------------------	---	--

240V, 50/60Hz	VG35-ERS4KQ Consisting of: 1 pc Valve VG35-ERS 1 pc Solenoid valve VE03-ESC014K2 1 pc Cable head 240V AC/DC, LED+VDR	
------------------	---	--

Complete valves, ISO size 2

Without manifold

VG35-ERER

Supply voltage	Order code	
----------------	------------	---

24VDC	VG35-ERER2CQ Consisting of: 1 pc Valve VG35-ERER 2 pcs Solenoid valves VE03-ESP002C2 2 pcs Cable heads 24VDC, LED+diode	
-------	--	--

24V, 50/60Hz	VG35-ERER4CQ Consisting of: 1 pc Valve VG35-ERER 2 pcs Solenoid valves VE03-ESC014C2 2 pcs Cable heads 24V AC/DC, LED+VDR	
-----------------	--	--

110V, 50/60Hz	VG35-ERER4EQ Consisting of: 1 pc Valve VG35-ERER 2 pcs Solenoid valves VE03-ESC014E2 2 pcs Cable heads 110V AC/DC, LED+VDR	
------------------	---	--

220V, 50/60Hz	VG35-ERER4HQ Consisting of: 1 pc Valve VG35-ERER 2 pcs Solenoid valves VE03-ESC014H2 2 pcs Cable heads 220V AC/DC, LED+VDR	
------------------	---	--

240V, 50/60Hz	VG35-ERER4KQ Consisting of: 1 pc Valve VG35-ERER 2 pcs Solenoid valves VE03-ESC014K2 2 pcs Cable heads 240V AC/DC, LED+VDR	
------------------	---	--

Complete valves

Complete factory-assembled valves, consisting of:
 Directional control valve
 Solenoid valve(s)
 Cable head(s)

Complete valves, ISO size 3

Without manifold

VG45-ERS

Supply voltage

Order code

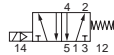

24VDC **VG45-ERS2CQ**
 Consisting of:
 1 pc Valve VG45-ERS
 1 pc Solenoid valve VE03-ESP002C2
 1 pc Cable head 24VDC, LED+diode

24V,
50/60Hz **VG45-ERS4CQ**
 Consisting of:
 1 pc Valve VG45-ERS
 1 pc Solenoid valve VE03-ESC014C2
 1 pc Cable head 24V AC/DC, LED+VDR

110V,
50/60Hz **VG45-ERS4EQ**
 Consisting of:
 1 pc Valve VG45-ERS
 1 pc Solenoid valve VE03-ESC014E2
 1 pc Cable head 110V AC/DC, LED+VDR

220V,
50/60Hz **VG45-ERS4HQ**
 Consisting of:
 1 pc Valve VG45-ERS
 1 pc Solenoid valve VE03-ESC014H2
 1 pc Cable head 220V AC/DC, LED+VDR

240V,
50/60Hz **VG45-ERS4KQ**
 Consisting of:
 1 pc Valve VG45-ERS
 1 pc Solenoid valve VE03-ESC014K2
 1 pc Cable head 240V AC/DC, LED+VDR

Complete valves, ISO size 3

Without manifold

VG45-ERER

Supply voltage

Order code



24VDC **VG45-ERER2CQ**
 Consisting of:
 1 pc Valve VG45-ERER
 2 pcs Solenoid valves VE03-ESP002C2
 2 pcs Cable heads 24VDC, LED+diode

24V,
50/60Hz **VG45-ERER4CQ**
 Consisting of:
 1 pc Valve VG45-ERER
 2 pcs Solenoid valves VE03-ESC014C2
 2 pcs Cable heads 24V AC/DC, LED+VDR

110V,
50/60Hz **VG45-ERER4EQ**
 Consisting of:
 1 pc Valve VG45-ERER
 2 pcs Solenoid valves VE03-ESC014E2
 2 pcs Cable heads 110V AC/DC, LED+VDR

220V,
50/60Hz **VG45-ERER4HQ**
 Consisting of:
 1 pc Valve VG45-ERER
 2 pcs Solenoid valves VE03-ESC014H2
 2 pcs Cable heads 220V AC/DC, LED+VDR

240V,
50/60Hz **VG45-ERER4KQ**
 Consisting of:
 1 pc Valve VG45-ERER
 2 pcs Solenoid valves VE03-ESC014K2
 2 pcs Cable heads 240V AC/DC, LED+VDR

VE03 solenoid valves

One solenoid valve is needed for each E in the order code number.

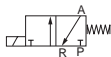

Voltage	Order code
	
Miniature solenoid valves	
24VDC, 2 W	VE03-ESP002C2
24VDC, 4 W	VE03-ESC012C2
24V, 50/60Hz	VE03-ESC014C2
110V, 50/60Hz	VE03-ESC014E2
220V, 50/60Hz	VE03-ESC014H2
240V, 50/60Hz	VE03-ESC014K2

Cable head, Type A

Suitable for use with VE03



Designation	Order code
24V DC, LED+Diode	9125 9980-03
24V AC/DC, LED+VDR	9125 9980-05
110V AC/DC, LED+VDR	9125 9980-07
240V AC/DC, LED+VDR	9125 9980-09
Black	9141 1525-00

VE13 solenoid valves

One solenoid valve is needed for each E in the order code number.



Voltage	Order code
	
24VDC, 2 W	VE13-ESP012C2
24VDC, 8 W	VE13-ESC042C2
24V/50Hz	VE13-ESC044C2
110V/50Hz	VE13-ESC044E2
220V/50Hz	VE13-ESC044H2
240V/50Hz	VE13-ESC044K2

Cable head, Type A

Suitable for use with VE13 and VG13



Designation	Order code
24V, LED+Diode	9125 9980-04
24V AC/DC, LED+VDR	9125 9980-06
110V AC/DC, LED+VDR	9125 9980-08
240V AC/DC, LED+VDR	9125 9980-10
Black	9141 9980-11

CNOMO solenoids

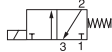

Voltage	Order code
	
24VDC (48V 50Hz)	P2G-PV32C1
24V/50Hz/60Hz (11VDC)	P2G-PV34C1
110V/50Hz/60Hz (50VDC)	P2G-PV34E1
230V/50Hz/60Hz (120VDC)	P2G-PV34J1
12V/50Hz/60Hz (6VDC)	P2G-PV34B1

Technical data

Valve	VE03-ESC01	VE03-ESP00	VE13-ESC04	VE13-ESP01	VG13-ESC16
Working pressure	10 bar	7 bar	10 bar	10 bar	10 bar
Working temperature	-10 to +55 °C	-10 to +55 °C	-10 to +55 °C	-10 to +55 °C	-15 to +50 °C
Orifice	Ø1,2 mm	Ø1,0 mm	Ø2,0 mm	Ø1,2 mm	Ø1,7 mm
Inrush power	4 W/9 VA	2 W/4,5 VA	8 W/21 VA	2 W/5,3 VA	6,8 W/14,5 VA
Holding power	4 W/6 VA	2 W/3 VA	8 W/12 VA	2 W/3 VA	6,8 W/10,5 VA

Transients

When the current through the coil of the solenoid valve is interrupted, the collapse of the magnetic field produces a high reverse voltage which, for DC and, in unfavourable cases, also for AC, can amount to several hundred times the supply voltage. Normally, these voltage transients do not cause any problems but, in order to ensure maximum life of relays, and particularly if there are transistors or thyristors in the circuit, some form of transient protection should be employed. For DC

applications, the most effective is a reverse-connected diode (spark arrester) across the solenoid coil. Several alternatives are available for AC, such as a suitably rated RC circuit. However, the simplest solution is to select a cable head with integral voltage-dependent resistor (VDR) (both for AC and DC), or with a diode (DC only).

Faster, simpler and more reliable Electric installation

Combining Valvetronic 110 with ISO valves simplifies the time-consuming work of running cables and brings all the signal cables together to a single block, making them easy to check.

The Valvetronic 110 can be used to coordinate sensor signals from the machine and control signals to the valves, producing a single unit in the machine for pneumatic and electric control.

Valvetronic 110 with its convenient 8 mm contacts provides protection class IP67.

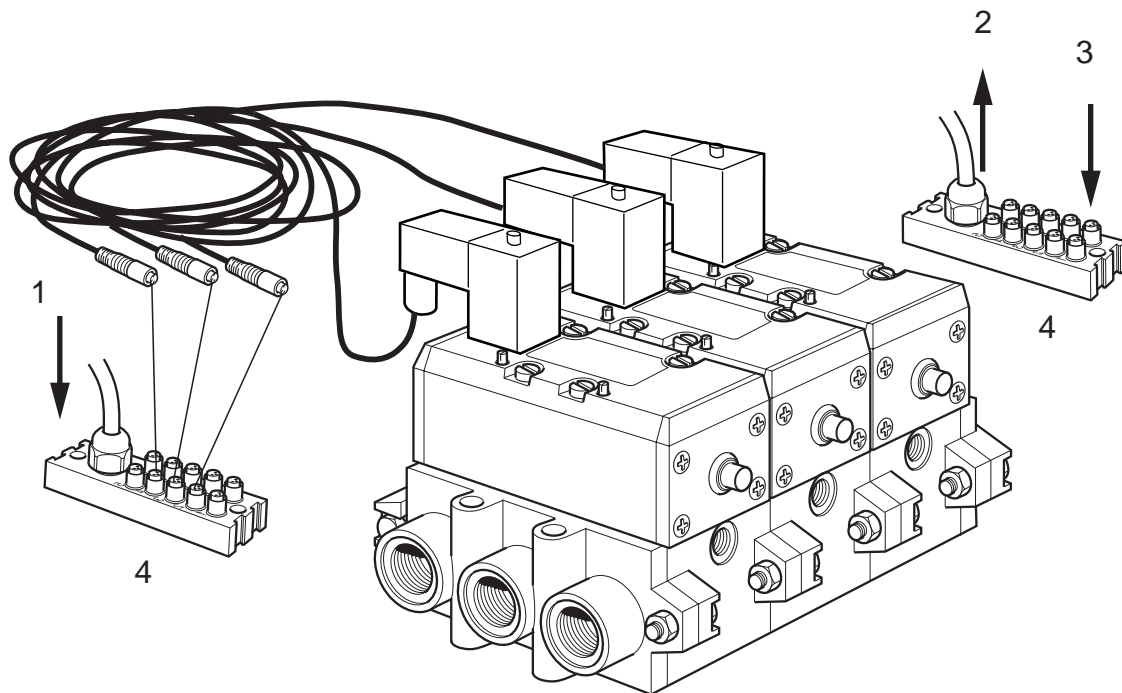

1. Output signals from the control system.
2. Input signals to the control system.
3. Sensor signals to the Valvetronic unit.
4. Valvetronic 110.

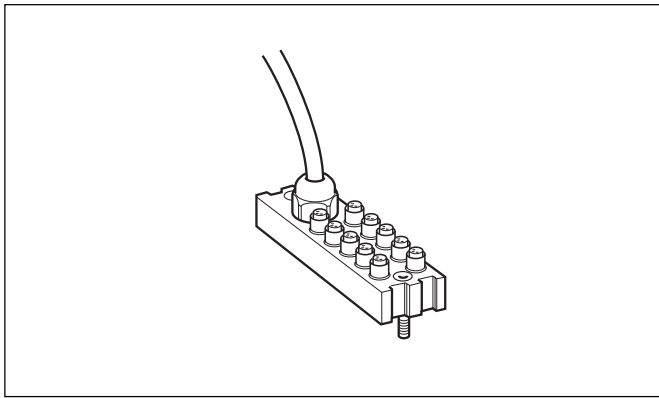

Technical data Valvetronic 110

Signal connections:

Ten 3-pole numbered 8 mm round push-in contacts:

- Input block
- 1. Common +24 V DC
 - 2. Input signal
 - 3. Common 0 V
- Output block
- 1. Common earth
 - 2. Output signal
 - 3. Common 0 V

NB:
A special adaptor cable must be used when using reed relay contacts.
Order code

Mechanical data:

Protection class IP67, DIN 40 050 when contacts and/or blanking plugs are fitted.
Temperature -20 to +70 °C

Material:

Body PA 6.6 VO to UL 94
Contact holder PB1P
Push-in ring LDPE
Filling resin Epoxy
Seal NBR
Screws Steel, surface-protected

Cable:

Length 3 m or 10 m
Type LifYY11Y
Cores 12
CSA 0.34 mm²
Colour coding To DIN 47 100

Electric data:

Voltage 24 V DC (max. 60 V AC / 75 V DC)
Insulation class C to DIN 0110
Load Max. 1 A per connection
3 A total

Valvetronic 110 signal unit

The Valvetronic 110 is a special terminating and cable connection block that can be used to collect signals from sensors on a machine and connect them to the control system through a multicore cable. It can also be used to provide a central connection point for the output signals from the control system, from where they can be distributed to the various destination points. It carries ten 8 mm round push-in contacts and a 3 m or 10 m multicore cable. The connections on the block are numbered from 1 to 10. Blanking plugs are available as accessories for blocking connections that are not to be used, and labels are also available for marking the blocks.

Valvetronic 110

Designation	Order code	Weight kg
Valvetronic 110 with 3 m cable	9121 7190-01	0,32
Valvetronic 110 with 10 m cable	9121 7190-02	0,95
Blanking plugs, pack of 10	9121 7190-03	0,02
Labels, pack of 10	9121 7190-04	0,02

Industrial durability:

Good resistance to oils and chemicals. Tests should be performed before use in aggressive environments.



Blanking plug
Used to close connections not in use.



Label, white, for identification etc.
For insertion in slot on the side of the Valvetronic 110.

Dimensions and connection diagram

Core	Colour	Input	Output
1	Pink	Signal 1	Signal 1
2	Grey	Signal 2	Signal 2
3	Yellow	Signal 3	Signal 3
4	Green	Signal 4	Signal 4
5	White	Signal 5	Signal 5
6	Red	Signal 6	Signal 6
7	Black	Signal 7	Signal 7
8	Violet	Signal 8	Signal 8
9	Grey/pink	Signal 9	Signal 9
10	Red/blue	Signal 10	Signal 10
A	Blue	0 V	0 V
B	Brown	+24 V	PE

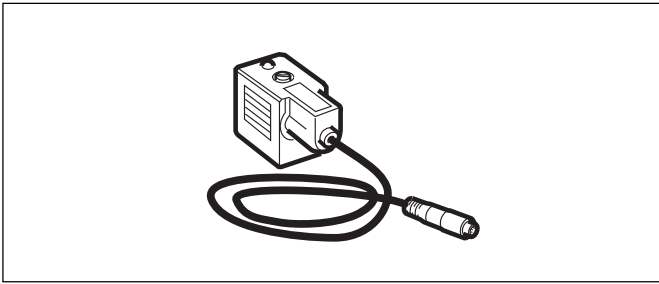

Cable head with cable

Cable head with moulded cable and 8 mm push-in connector for connection of conventional solenoid valves to the Valvetronic system. The cable head incorporates an LED and transient protection. If a longer cable is required, use the extension cables as listed below.

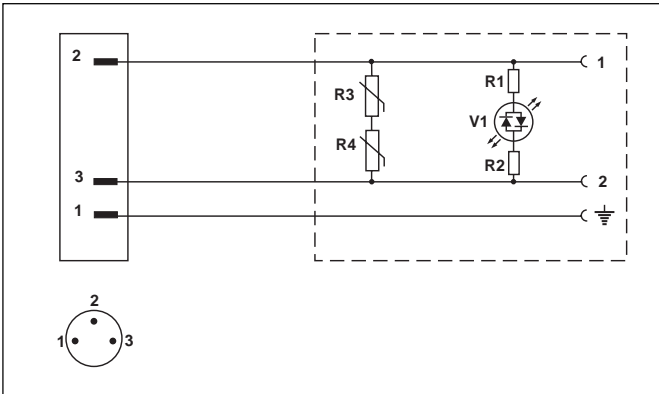

Technical data

General

Voltage	24 V AC/DC
Indication	LED, yellow
Transient protection	VDR
Load, max.	4 A
Enclosure	IP65

Cable head to DIN 43650

Designation	Order code	Weight kg
-------------	------------	--------------

Cable head, type A

Suitable for VE13 and VG13
 Cable length, 0,3 m
 Cable length, 0,6 m

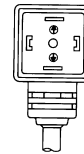

9121 7190-20	0,07
9121 7190-21	0,09

Cable head, type B1

Suitable for VE03
 Cable length, 0,3 m
 Cable length, 0,6 m

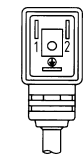

9121 7190-25	0,07
9121 7190-26	0,09

Cable head, type B2

Suitable for VE03
 Cable length, 0,3 m
 Cable length, 0,6 m

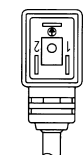

9121 7190-30	0,07
9121 7190-31	0,09

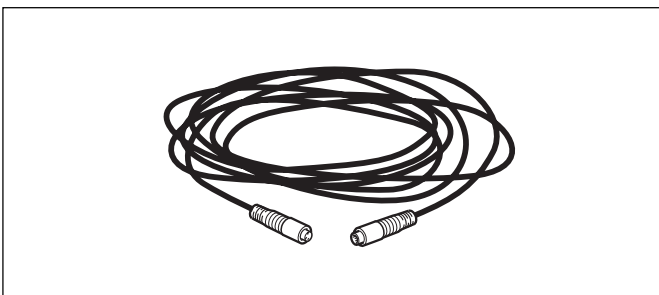

Technical data

Contacts

Moulded 8 mm push-in male/female contacts
 Enclosure IP 67

Cable

Cores	3 x 0.25 mm ² (32 x 0.10 mm ²)
Sheath	PVC / PUR
Colour	Black

Ready-to-use extension cables

These cables have moulded 8 mm round push-in connectors at both ends, and are supplied in two types: one with straight 3-pole male and female contacts, and one with a straight 3-pole male contact at one end and an angled 3-pole female contact at the other.

Cables with straight 3-pole male and female connectors,

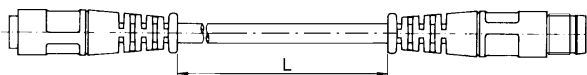



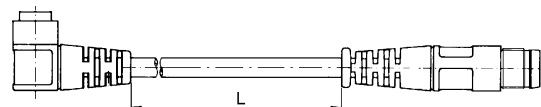





Cables with a straight 3-pole male connector at one end and a right-angle female connector at the other.





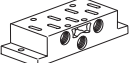

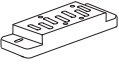



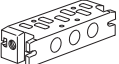

Designation	Order code	Weight kg
Cable with straight connectors , 0,2 m	9121 7170-14	0,02
Cable with straight connectors , 0,3 m	9121 7170-15	0,02
Cable with straight connectors , 0,5 m	9121 7170-16	0,03
Cable with straight connectors , 1,0 m	9121 7170-17	0,03
Cable with straight connectors , 2,0 m	9121 7170-18	0,05
Cable with straight connectors , 3,0 m	9121 7170-19	0,07
Cable with straight connectors , 5,0 m	9121 7170-20	0,12
Cable with straight connectors , 10 m	9121 7170-21	0,23

Designation	Order code	Weight kg
Cable with straight and elbow connect. 0,2 m	9121 7170-22	0,02
Cable with straight and elbow connect. 0,3 m	9121 7170-23	0,02
Cable with straight and elbow connect. 0,5 m	9121 7170-24	0,03
Cable with straight and elbow connect. 1,0 m	9121 7170-25	0,03
Cable with straight and elbow connect. 2,0 m	9121 7170-26	0,05
Cable with straight and elbow connect. 3,0 m	9121 7170-27	0,07
Cable with straight and elbow connect. 5,0 m	9121 7170-28	0,12
Cable with straight and elbow connect. 10 m	9121 7170-29	0,23



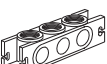

Single subbases, ISO size 1

Accessory	Designation	Connection	Weight Kg	Order code
	 Subbase, ISO1-1 With G1/4 side connection, compact	G1/4	0,17	P2N-AS512SD
	 Subbase, ISO1-1 With G1/8 side connection	G1/8	0,31	P2N-GS511SD
	 Subbase, ISO1-A With G1/4 side connection, to VDMA 24345, Form A	G1/4	0,16	P2N-VS512SD
	 Subbase, ISO1-2 With G1/4 bottom connection	G1/4	0,29	P2N-GS512SB

Manifolds, bottom connection, compact ISO size 1

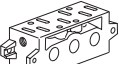







Accessory	Designation	Connection	Weight Kg	Order code
	 Manifold, ISO1-M Including O-rings and stainless steel mounting bolts. Ports 2 and 4 bottom connection, ports 12 and 14 either end or bottom connection.	G1/4	0,20	P2N-AM512MB
	 Connecting block, ISO1-S with G3/8 side connections, including seals and stainless steel fitting bolts.	G3/8	0,15	P2N-AM513GS
	 Connecting block, ISO1-L with G3/8 connections from above or below, including seals and stainless steel fitting bolts.	G3/8	0,15	P2N-AM513GT
	 Intermediate block, ISO1-T with G3/8 connections from above or below, including seals and stainless steel fitting bolts.	G3/8	0,14	P2N-AM513BT
	 End piece including stainless steel fitting bolts.		0,06	P2N-AM500J
	Isolating seal for sealing between blocks with different primary pressures.		0,07	P2N-AK0P

Manifolds, bottom connection, VDMA ISO size 1



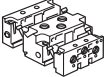

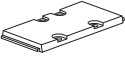



Accessory	Designation	Connection	Weight Kg	Order code
	 Manifold, ISO1-C Including O-rings and stainless steel mounting bolts. Ports 2 and 4 bottom connection, ports 12 and 14 end connection, to VDMA 24345, Form C.	G1/4	0,24	P2N-VM512MB
	 Connecting kit, ISO1-D with G3/8 side connections, including O-rings and fitting bolts. Supplied in pairs. To VDMA 24345, Form C.	G3/8	0,21	P2N-VM513E
	Adaptor plate between ISO1 - ISO3. VDMA multiple manifolds, including O-rings and fitting bolts.		0,55	P2N-VM500AK

Material specification, please see page 26.





Manifolds, side connection, ISO size 1

Accessory	Designation	Connection	Weight Kg	Order code
	 Manifold, ISO1-TS With G1/4 side connection, including O-rings and fitting bolts	G1/4	0,06	P2N-EM512MD
	 Connecting kit, ISO1-TS With G3/8 side connection, including O-rings and fitting bolts	G3/8	0,21	P2N-EM513ES
	 Adaptor set, ISO1 - ISO2 Including front and rear block, seal and fitting bolts		1,60	P2N-EM500AG
	Bracket For fitting to DIN rail. Four required per valve block.		0,10	9121 7184-90
	Blanking plate, ISO1 Including seal and fitting bolts		0,10	P2N-AA5B
	Stainless steel fitting bolts Four stainless steel bolts for VG25		0,10	9121 5902-69

Single subbases, ISO size 2

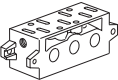

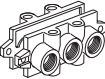





Accessory	Designation	Connection	Weight Kg	Order code
	 Subbase, ISO2-A with G3/8 side connections, to VDMA 24345, Form A.	G3/8	0,28	P2N-WS513S
	 Subbase, ISO2-1 with G1/4 side connections	G1/4	0,53	P2N-HS512SS
	 Subbase, ISO2-1 with G1/2 side connections	G1/2	0,50	P2N-HS514SS
	 Subbase, ISO2-2 with G3/8 side connections	G3/8	0,57	P2N-HS513SB

Manifolds, bottom connection, VDMA ISO size 2



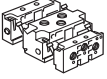

Accessory	Designation	Connection	Weight Kg	Order code
	 Manifold, ISO2-C Including O-rings and fitting bolts. Ports 2 and 4 bottom connection, ports 12 and 14 end connection, to VDMA 24345, Form C.	G3/8	0,36	P2N-WM513MB
	 Connecting kit, ISO2-D with G1/2 side connections, including O-rings and fitting bolts. Supplied in pairs. To VDMA 24345, Form D.	G1/2	0,34	P2N-WM514ES

Material specification, please see page 26.



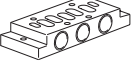

Manifold, side connection, ISO size 2

Accessory	Designation	Connection	Weight Kg	Order code
	 Manifold, ISO2-TS With G3/8 side connection, including O-rings and fitting bolts	G3/8	0,93	P2N-FM513MD
	 Connecting kit, ISO2-TS With G1/2 side connection, including O-rings and fitting bolts	G1/2	0,29	P2N-FM514ES
	 Adaptor set, ISO1 - ISO2 Including front and rear block, seal and fitting bolts		1,60	P2N-EM500AG
	Bracket For fitting to DIN rail. Four required per valve block.		0,10	9121 7184-90
	Blanking plate, ISO2 Including seal and fitting bolts		0,15	P2N-BA5B

Single subbases, ISO size 3

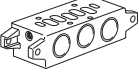



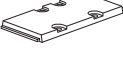
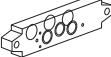

Accessory	Designation	Connection	Weight Kg	Order code Reference no.
	 Subbase, ISO3-A with G1/2 side connections, to VDMA 24345, Form A.	G1/2	0,34	P2N-YS514SD
	 Subbase, ISO3-1 with G3/4 side connections	G3/4	0,57	P2N-JS516SD

Manifolds, bottom connection, VDMA ISO size 3







Accessory	Designation	Connection	Weight Kg	Order code
	 Manifold, ISO3-C Including O-rings and fitting bolts. Ports 2 and 4 bottom connection, ports 12 and 14 end or bottom connection, to VDMA 24345, Form C.	G1/2	0,70	P2N-YM514MB
	 Connecting kit, ISO3-D with G1 side connections, including O-rings and fitting bolts. Supplied in pairs. To VDMA 24345, Form D.	G1	0,68	P2N-YM518ES
	Blanking plate, ISO3 Including seal and fitting bolts		0,20	P2N-CA5B
	Adaptor plate, ISO1 - ISO3 VDMA multiple blocks, including O-rings and fitting bolts		0,53	P2N-VM500AK

Material specification, please see page 26.





Single subbases, ISO size 4

Accessory	Designation	Connection	Weight Kg	Order code
	 Subbase, ISO4-1 with G1/2 side connections with built-in restrictor	G1/2	0,69	P2N-DS514SD
	 Subbase, ISO4-2 with G1/2 side connections with built-in restrictor	G1/2	0,88	P2N-DS514SB
	 Subbase, ISO4 with G3/4 side connections. To VDMA 24345, Form A	G3/4	0,95	P2N-ZS516SS

Manifolds, bottom connection, ISO size 4

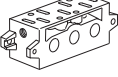
Accessory	Designation	Connection	Weight Kg	Order code Reference no.
	 Manifold, ISO4-A Inlet section, including O-rings. Ports 2 and 4, as well as ports 12 and 14, are bottom connection, to VDMA 24345, Form C.	G1/2	0,65	P2N-DM514GB
	 Manifold, ISO4-M Intermediate section, including O-rings and fitting set. Ports 2 and 4, as well as ports 12 and 14, are bottom connection, to VDMA 24345, Form C.	G1/2	0,69	P2N-DM514BB
	 Manifold, ISO4-B End section, including O-rings and fitting set. Ports 2 and 4, as well as ports 12 and 14, are bottom connection, to VDMA 24345, Form C.	G1/2	0,80	P2N-DM514HB

Manifolds, VDMA ISO size 4

Accessory	Designation	Connection	Weight Kg	Order code Reference no.
	 Manifold, ISO4-C Ports 2 and 4 bottom connection, ports 12 and 14 side connection, to VDMA 24345, Form C.	G3/4	1,40	P2N-ZM516MB
	 Connection kit, ISO4-D with G1 side connections. Supplied in pairs. To VDMA 24345, Form D.	G1	0,65	P2N-ZM518ES
	Blanking plate Including seal and fitting bolts		0,15	P2N-DA5B

Material specification

Manifolds size 1 to 3 (except for P2N-E... and P2N-F...)

Mounting screws Galvanised steel
Manifolds Electrically anodised aluminium

Manifolds size 1 and 2 (All with P2N-E... and P2N-F...)

Mounting screws Yellow chrome plated steel
Cover Yellow chrome plated steel
Manifolds Zinc

Manifolds size 4

Mounting screws Galvanised steel
Throttle inserts Galvanised steel
Manifolds Electrically anodised aluminium

Dimensions

VG25-AA

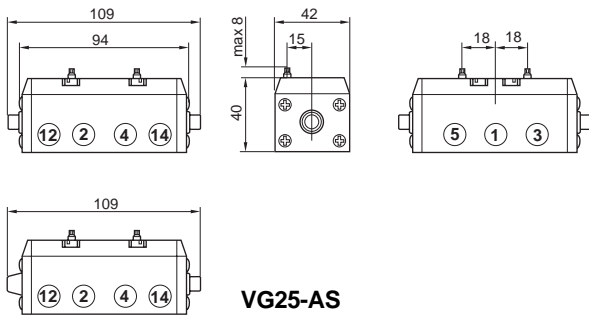

VG25-AS

VG25-AC, VG25-XAC, VG25-YAC

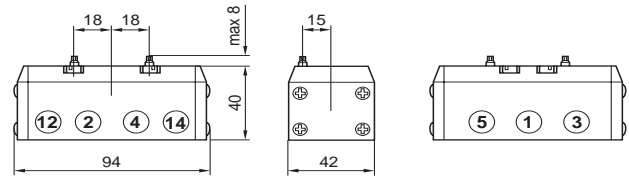

VG25-ERER, VG25-EAEA

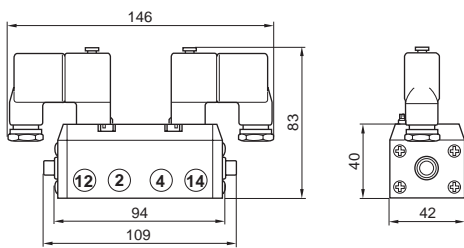

VG25-AERER, VG25-AEAEA

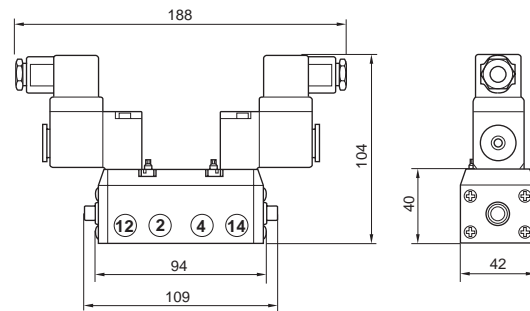

VG25-ERS, VG25-EAS

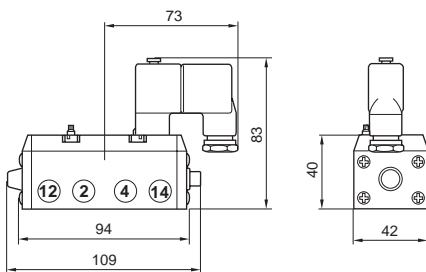

VG25-AERS, VG25-AEAS

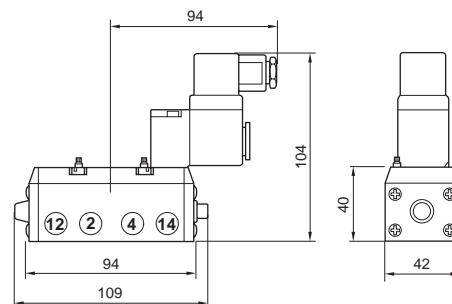

VG25-(X,Y)ERC, VG25-(X)EAC

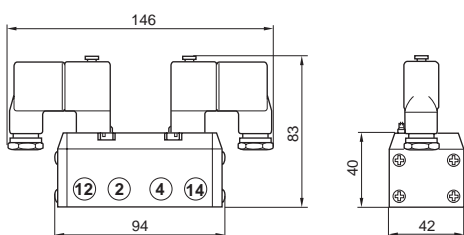

VG25-A(X)ERC, VG25-A(X)EAC

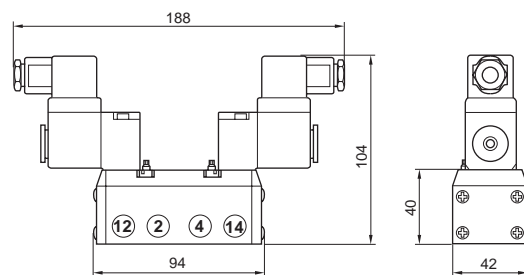

Dimensions

VG35-AA

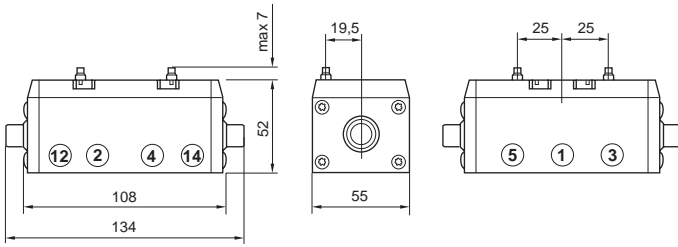

VG35-AS

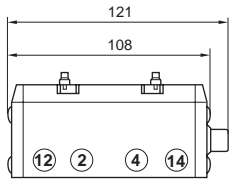

VG35-AC, VG35-XAC, VG35-YAC

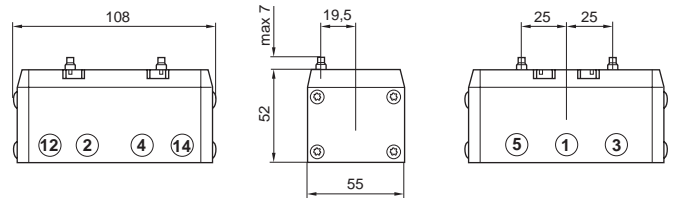

VG35-ERER, VG35-EAEA

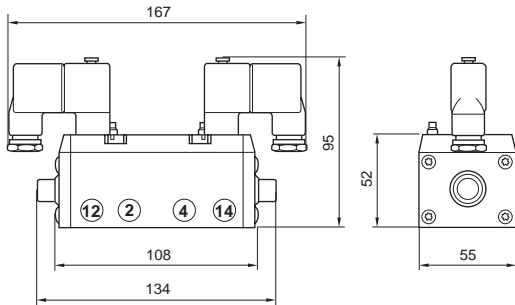

VG35-AERER, VG35-AEAEA

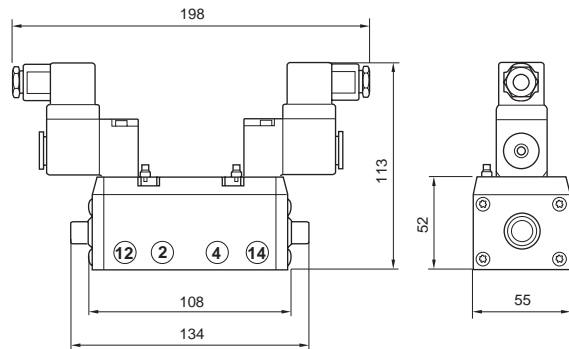

VG35-ERS, VG35-ERDR, VG35-EAS

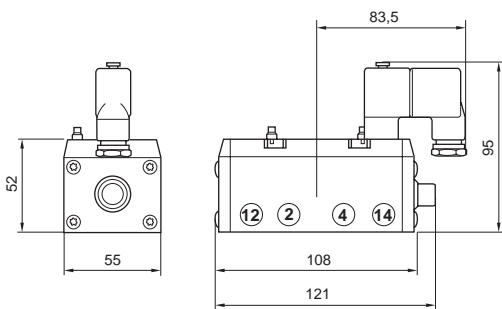

VG35-AERS, VG35-AEAS

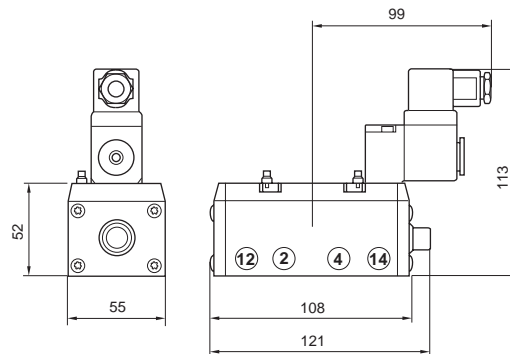

VG35-(X,Y)ERC, VG35-(X)EAC

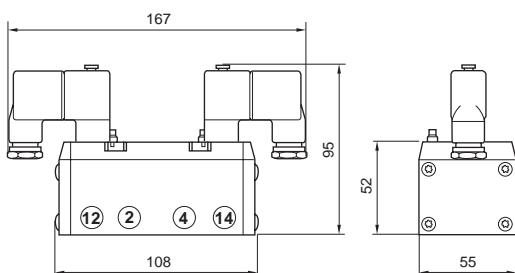

VG35-A(X)ERC, VG35-AEAC

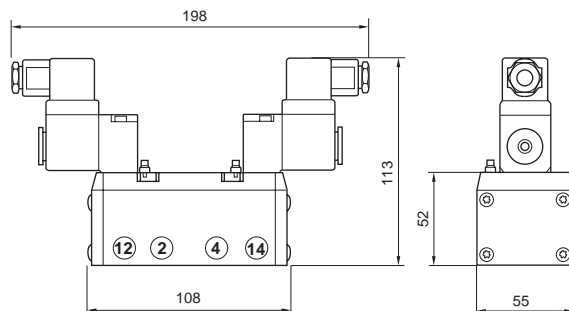

Dimensions

VG45-AA

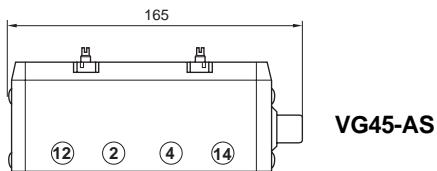
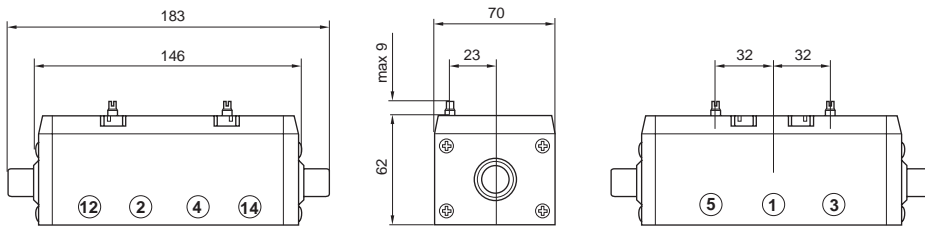

VG45-AC, VG45-XAC

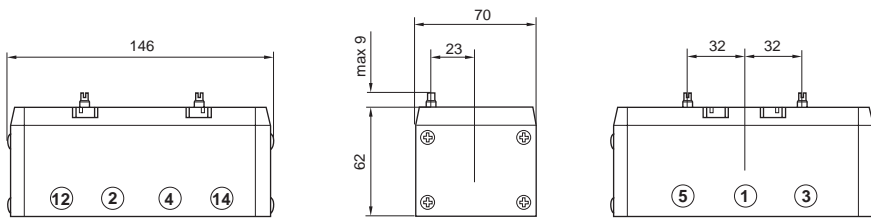

VG45-ERER, VG45-EAEA

VG45-ERS, VG45-EAS

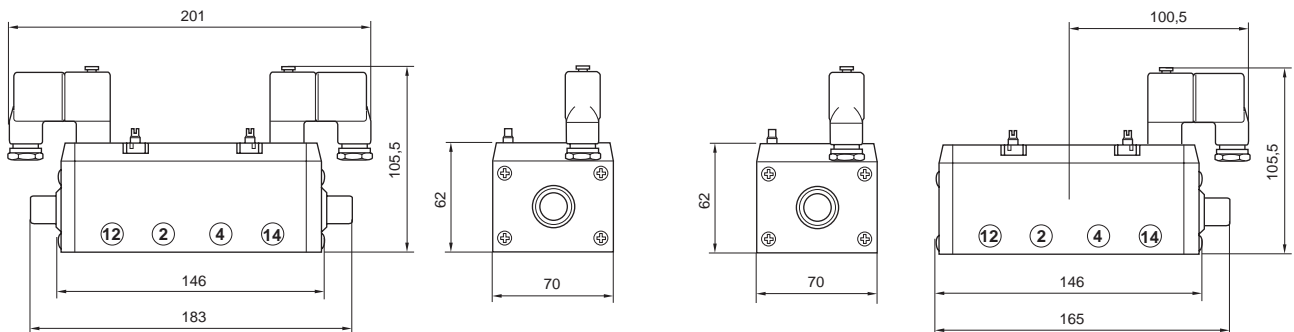

VG45-ERC, VG45-XERC

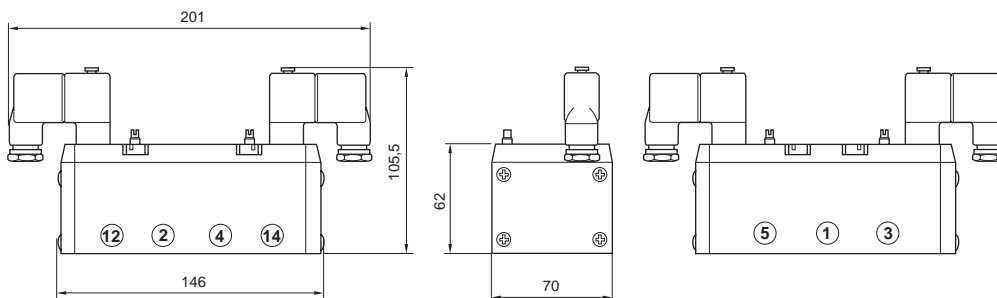

Dimensions

VG45-AERER, VG45-AEAEA

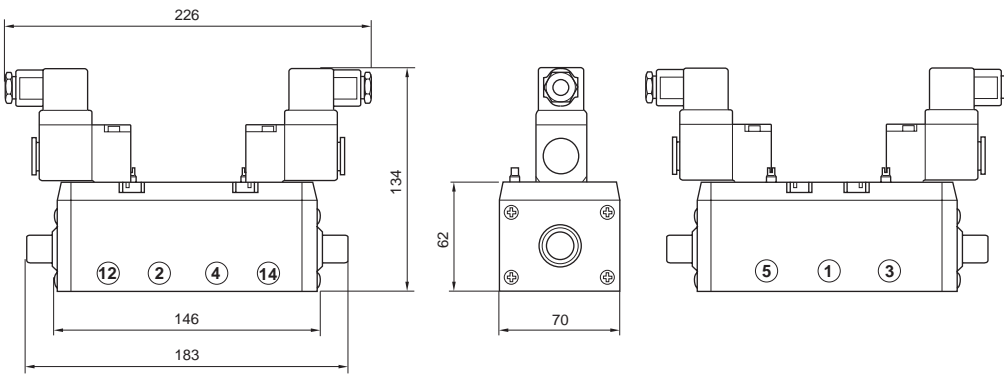

VG45-AERS, VG45-AEAS

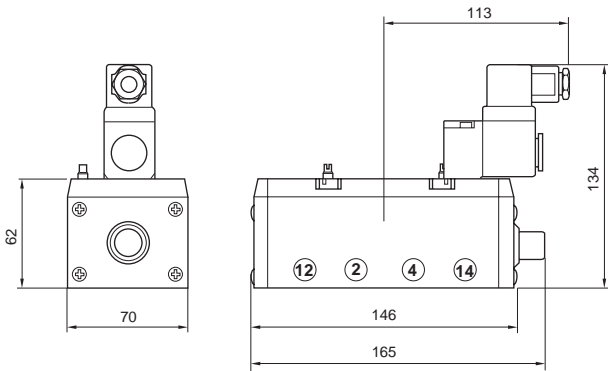

VG45-AERC, VG45-AXERC

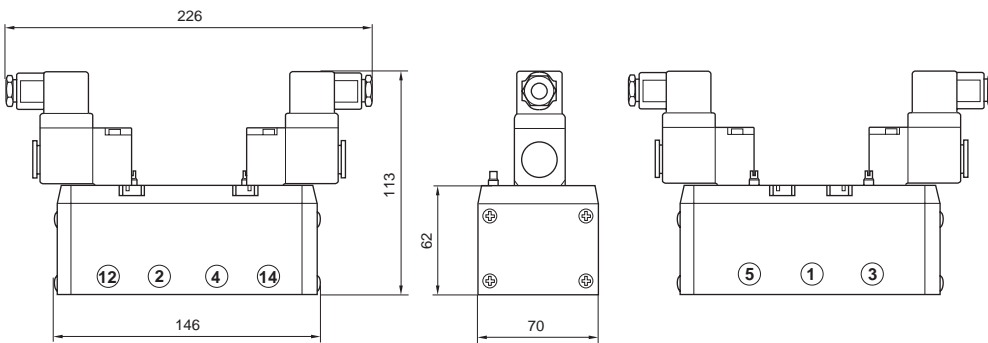

Dimensions

VE45 hand lever operated

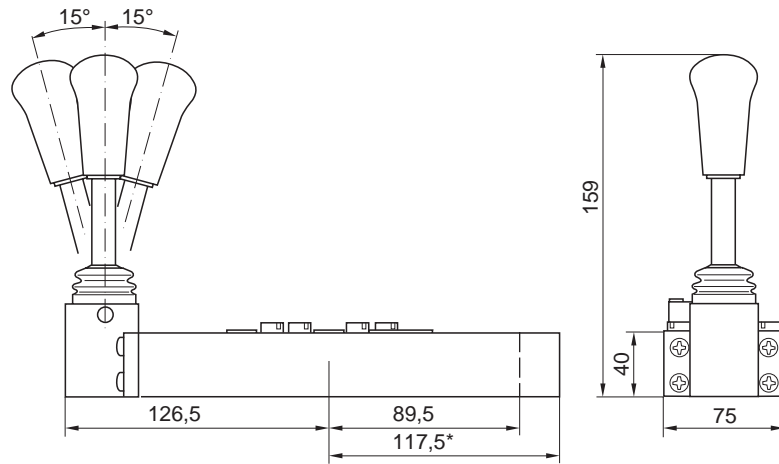

* Only VE45-HC

VE45 pneumatically actuated

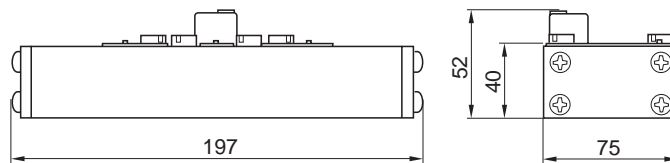

VE45 electrically actuated

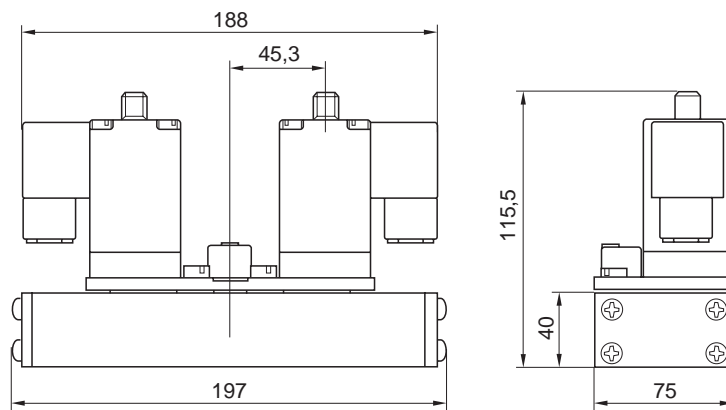

Dimensions

ISO1 subbases and manifolds, low-profile type

**Subbase, ISO1-1, side connection
P2N-AS512SD**

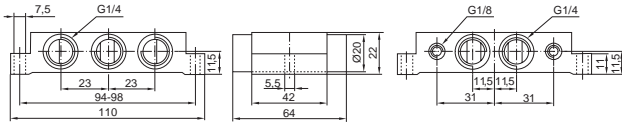

**Manifold, ISO1-M, bottom connection
P2N-AM512MB**

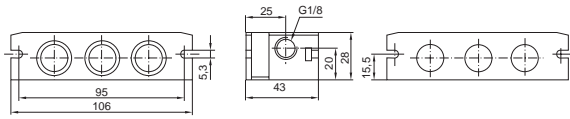

**Connection block, ISO1-S, side connection
P2N-AM513GS**

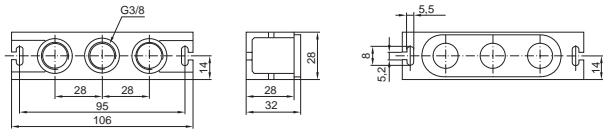

**Connection block, ISO1-L
P2N-AM513GT**

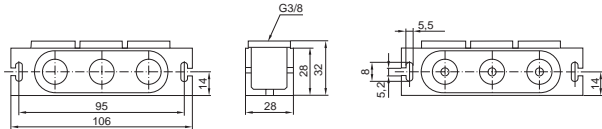

**Intermediate block, ISO1-T
P2N-AM513BT**

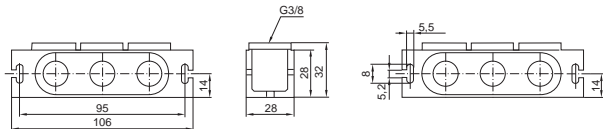

**End piece, ISO1-M
P2N-AM500J**

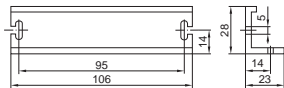

**Adaptor plate, ISO1 - ISO3
P2N-VM500AK**

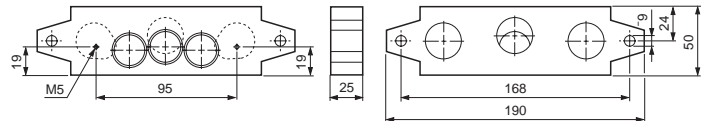

Manifolds, VDMA ISO sizes 1, 2 and 3

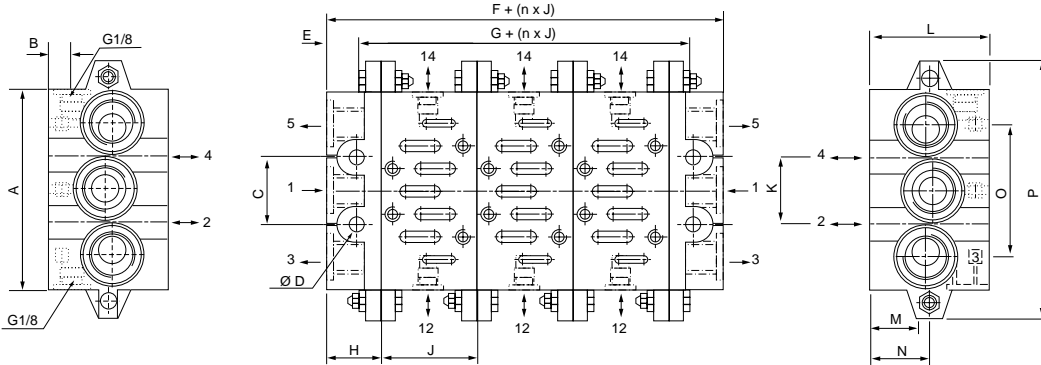

ISO size	Port 1,3,5	Port 2,4	A	B	C	D	E	F	G	H	J	K	L	M	N	O	P
1	G3/8	G1/4	85	8,5	28	7	11	44	22	22	43	26	46	21	24	56	110
2	G1/2	G3/8	100	9,0	35	9	13	52	26	26	56	30	47	22	24	68	135
3	G1	G1/2	140	10,0	52	12	15	60	30	30	71	38	56	31	34	104	190

Dimensions

ISO 1, 2 and 3 subbases, side connection

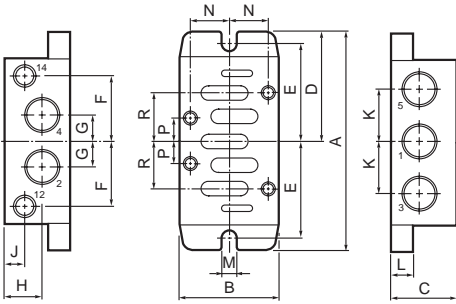

Type	ISO size	Port size	A	B	C	D	E	F	G	H	J	K	L	M	N	P	R
P2N-GS511SD	1	G1/8	100	40	29	50	45	30,5	11	18	10	22	10	5,4	14	9	18
P2N-HS512SS	2	G1/4	116	50	32	58	52	34,0	13	19	10	26	10	6,4	19	12	24
P2N-HS514SS	2	G1/2	124	51	42	62	56	37,0	18	24	10	34	10	6,4	19	12	24
P2N-JS516SD	3	G3/4	149	71	60	74,5	68	45,0	21	33	10	40	18	6,6	24	16	32

ISO 1 and 2 subbases, bottom connection

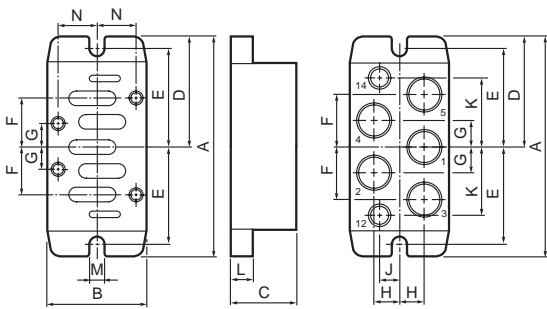

Typ	ISO storlek	Port storlek	A	B	C	D	E	F	G	H	J	K	L	M	N
P2N-GS512SB	1	G1/4	100	40	29	50	45	30,5	11	9,5	9,5	22	10	5,4	19
P2N-HS513SB	2	G3/8	116	50	32	58	52	24,0	12	12,5	10	26	10	6,4	19

VDMA ISO 1, 2 and 3 subbases, side connection

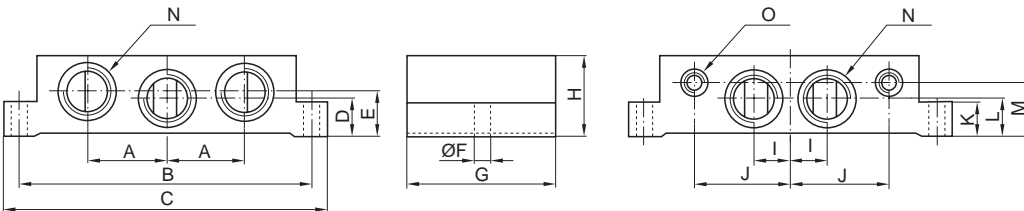

Type	ISO size	Port size	A	B	C	D	E	F	G	H	I	J	K	L	M	N	O
P2N-VS512SD	1	G1/4	21,5	98	110	11	20	5,5	48	32	12	29	10	11	23	G1/4	G1/8
P2N-WS513S	2	G3/8	28,0	112	124	14	26	6,6	56	40	15	37	13	14	30	G3/8	G1/8
P2N-YS514SD	3	G1/2	34,0	136	149	17	17	6,6	71	32	16	45	18	17	22	G1/2	G1/8

Side connection, ISO size 1 - P2N-EM512MD, P2N-EM513ES

Side connection, ISO size 2 - P2N-FM513MD, P2N-FM514ES

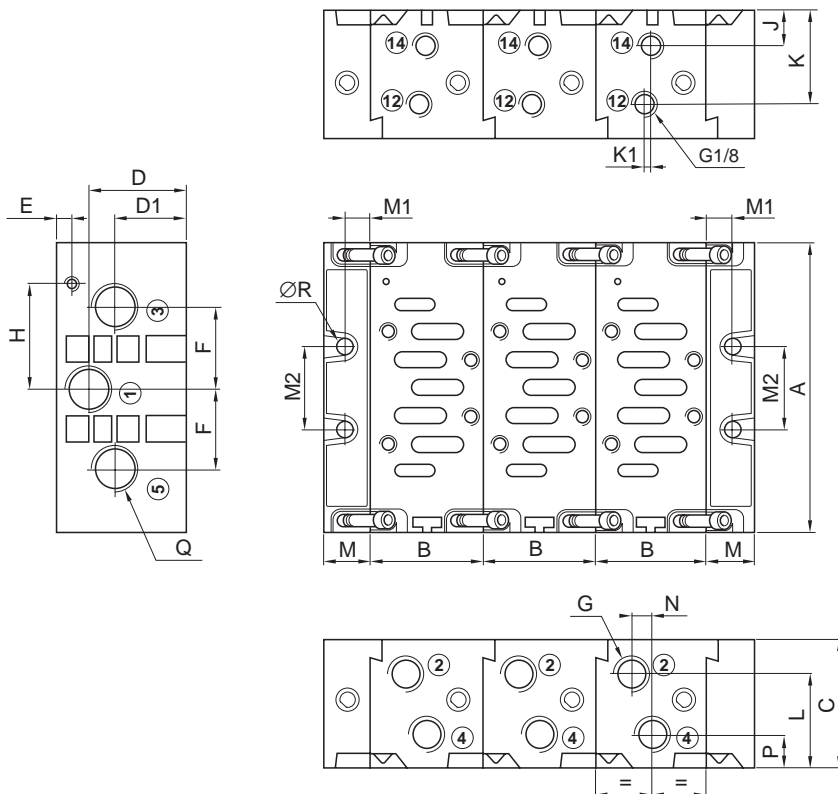

Type	A	B	C	D	D1	E	F	G	H	J	K	K1	L	M	M1	M2	N	P	Q	R
P2N-EM	110	43	48	35,5	26,5	5,5	28,0	1/4"	36	15,5	35,0	3	32	20	11	28	12,0	12,5	3/8"	6
P2N-FM	129	56	60	44,5	35,5	6,0	34,5	3/8"	45	16,0	41,5	3	41	24	13	35	12,5	16,0	1/2"	8

Adaptor plate, P2N-EM500AG

ISO manifold, size 2 Adaptor ISO manifold, size 1

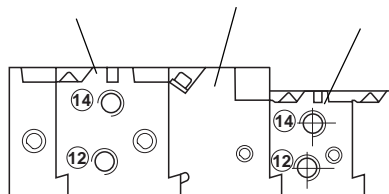

Other dimensions:
see the respective
manifold above

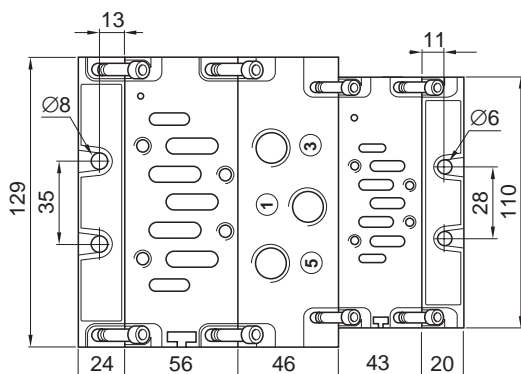

Dimensions

ISO4 subbases and manifolds

Subbase, side connection **P2N-DS514SD**

Subbase, bottom connection **P2N-DS514SB**

Manifold, inlet section **P2N-DM514GB**

Manifold, intermediate section **P2N-DM514BB**

Manifold, end section **P2N-DM514HB**

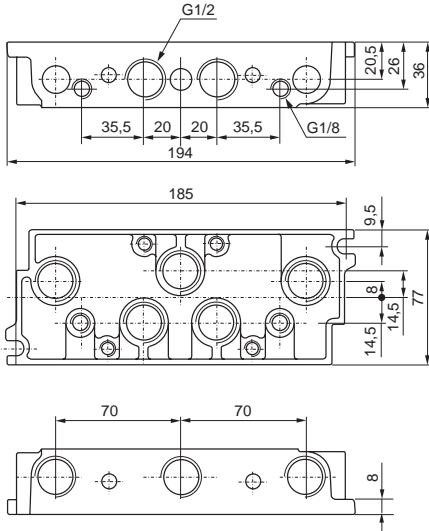

Subbase, VDMA, ISO4

Subbase **P2N-ZS516SS**

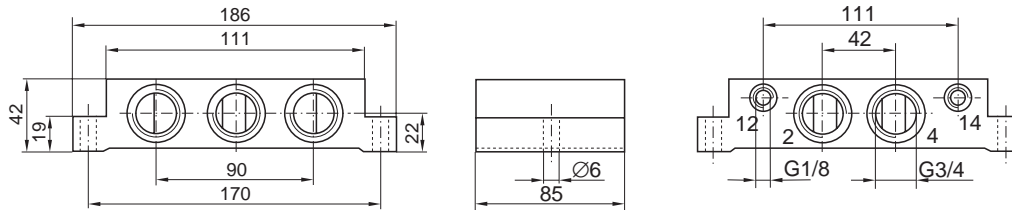

Manifolds, VDMA, ISO4

Manifold **P2N-ZM516MB**

Connection kit **P2N-ZM518ES** (supplied in pairs)

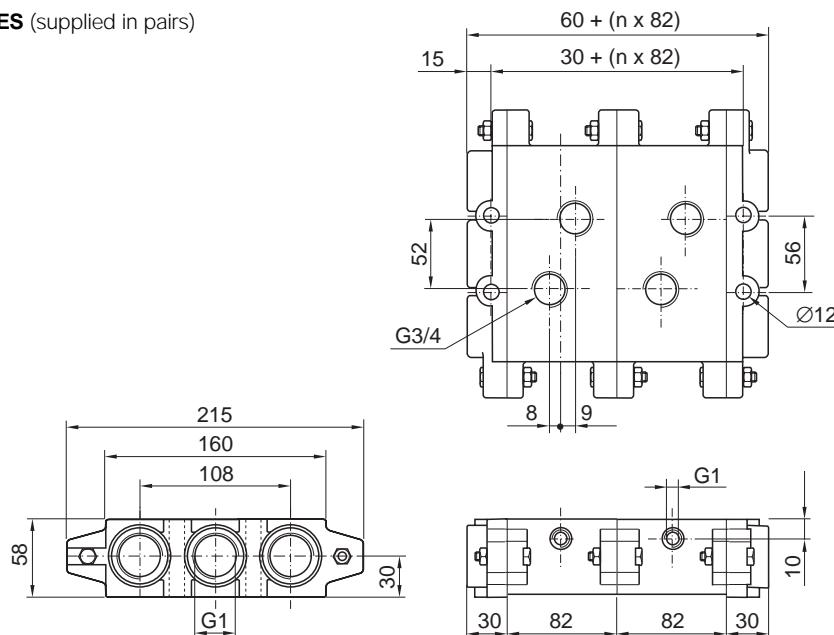

Service and Replacement Parts

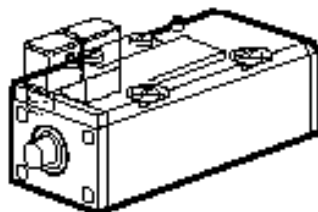

Flexflow Series ISO Valves

Size 1

Part Number	Repair Kit	Valve/base seal (10 seals/kit)	Throttle Insert Kit (10 inserts/kit)
VG25-AA	P2N-A6/S90066	P2N-A6/S90069	P2N-A6/S90068
VG25-AS			
VG25-ERER			
VG25-ERS			
VG25-AERER			
VG25-AERS			
VG25-XAC			
VG25-XERC			
VG25-AXERC			
VG25-AC	P2N-A6/S90067		
VG25-ERC			
VG25-AERC			

Size 2

Part Number	Repair Kit	Valve/base seal (10 seals/kit)	Throttle Insert Kit (10 inserts/kit)
VG35-AA	P2N-B6/S90070	P2N-B6/S90073	P2N-B6/S90072
VG35-AS			
VG35-ERER			
VG35-ERS			
VG35-AERER			
VG35-AERS			
VG35-XAC			
VG35-XERC			
VG35-AXERC			
VG35-AC			
VG35-ERC			
VG35-AERC			

Service and Replacement Parts

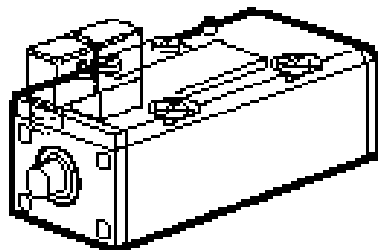

Flexflow Series ISO Valves

Size 3

Part Number	Repair Kit	Valve/base seal (10 seals/kit)	Throttle Insert Kit (10 inserts/kit)
VG45-AA	P2N-C6/S90074	P2N-C6/S90077	P2N-C6/S90076
VG45-AS			
VG45-ERER			
VG45-ERS			
VG45-AERER			
VG45-AERS			
VG45-XAC	P2N-C6/S90075	P2N-C6/S90077	P2N-C6/S90076
VG45-XERC			
VG45-AXERC			
VG45-AC			
VG45-ERC			
VG45-AERC			

Size 4

No Service Kits available, **replace complete valve.**

Replacement Solenoids

Voltage	Part Number	
	Upright Solenoid (ER)	CNOMO Solenoid (AER)
24vdc 2 watt	VE03-ESP002C2	Not available
24vdc	VE03-ESC012C2	P2G-PV32C1
24v 50/60Hz	VE03-ESC014C2	P2G-PV34C1
110v 50/60Hz	VE03-ESC014E2	P2G-PV34E1
220v/230v 50/60Hz	VE03-ESC014H2	P2G-PV34J1