

## Three-Lobed Torque Handles

24711.0409



### Product Description

Torque handles are used wherever a limitation of the exerted hand force is required. The three-lobed torque handle with integrated torque mechanism allows a defined torque limit during tightening. Reaching the torque results in an "over-locking". For releasing the torque is transmitted indefinitely. These handles combine the functionality of a ratchet wrench with the modern and ergonomic design of a three-lobed handle.

#### Material

##### Cap

- Plastic, light grey

##### Torque mechanism

- Steel, hardened

##### Handle

- Thermoplastic PA-HP, glass fibre reinforced, black, matt

##### Inner part

- Steel, blackened

##### Screw

- Steel, blackened

#### More information

##### Further products

- Torque Handles

### Drawing

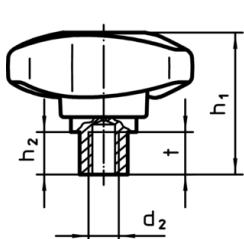

picture 1

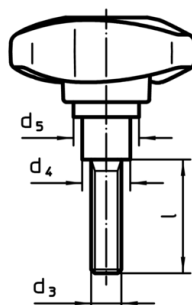
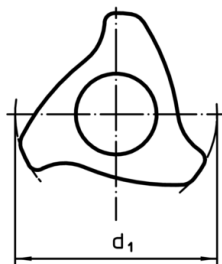

picture 2

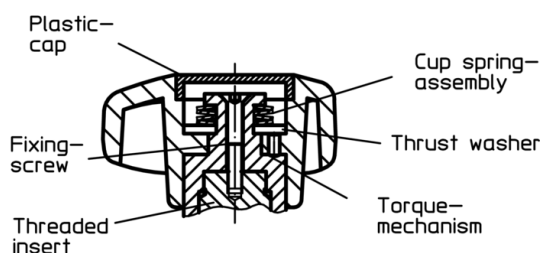

### Order information

Dimensions							Tightening torque +/- 10% max. [Nm]	[g]	Art. No.
d <sub>1</sub>	d <sub>3</sub>	l	d <sub>4</sub>	d <sub>5</sub>	h <sub>1</sub>	h <sub>2</sub>			
[mm]									
with screw – picture 2									
63	M8	50	16	28.1	46.6	12.9	3.2	128	24711.0409

## Application example

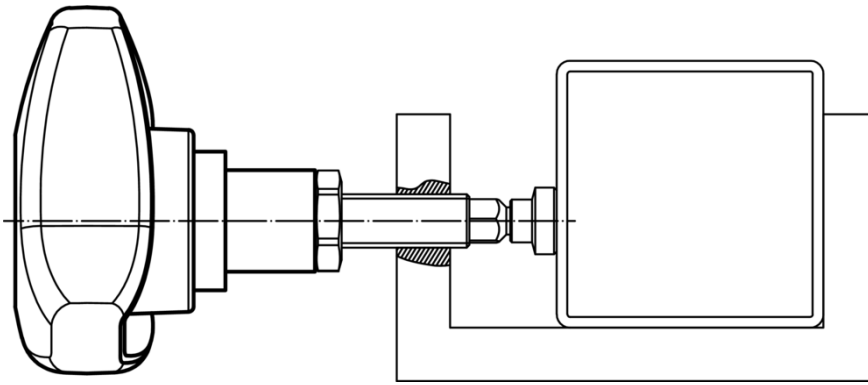

## Compliance

### RoHS compliant

Contains lead - compliant according to exceptions 6a / 6b / 6c

### Contains SVHC substances >0,1% w/w

Contains lead - SVHC list [REACH] as of 10.06.2022

### Contains Proposition 65 substances



Lead can cause cancer and reproductive harm from exposure  
<https://www.P65Warnings.ca.gov/>

### Free from Conflict Minerals

This product does not contain any substances designated as "conflict minerals" such as tantalum, tin, gold or tungsten from the Democratic Republic of Congo or adjacent countries.