

Valve connector BI type
Extension Cable
VIS02-S80E-1,5-RSC5.31T/TEL

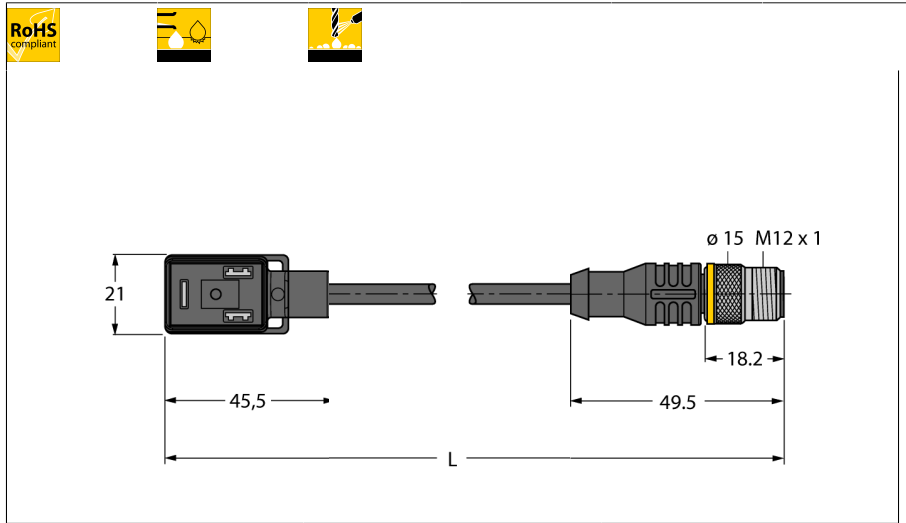

- 2-pin + PE
- Design according to the DIN EN 175301-803
- RoHS conform
- Protection class: IP67 and IP69K
- Protective component: Transil diode
- M12 male, straight, 2-pin + PE
- Sheath material: PVC
- Sheath color: black
- Resistant to chemicals and oils
- Flame retardant
- Resistant to acids and alkaline solutions
- Resistant to microbes and hydrolysis
- LABS-free
- Cable length: 1.5 m

Type designation VIS02-S80E-1,5-RSC5.31T/TEL
Ident no. 6606863

Connector A side
Valve connector, Design BI
Number of pins 2+PE
Contacts Metal, CuSn, Silver-plated
Contact carriers Plastic, PA, Black
Grip Plastic, TPU, Black/Translucent
Protective component Transil diode
Seal Plastic, TPU
Protection class IP67, IP69K, (mounted)
Display switch state LED yellow/yellow
Mechanical lifespan > 100 Mating cycles
Pollution degree 3

Pin Assignment

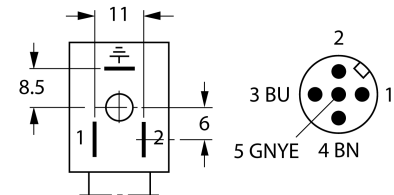

Circuit Diagram

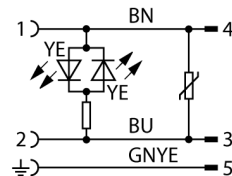

Connector B side
Connector, M12 x 1, Straight
Number of pins 2+PE pins
Contacts metal, CuZn, Gold-plated
Contact carriers Plastic, TPU, Black
Grip Plastic, TPU, Black
Coupling nut/screw Brass, CuZn, Nickel-plated
Protection class IP67, IP69K, Only when screwed tight
Mechanical lifespan > 100 Mating cycles
Pollution degree 3
Tightening torque 0.8 ... 1 Nm

General data
Cable diameter 5.3 ± 0.20mm
Cable length 1.5 m
Cable quality PVC
Cable color Black
Core insulation PVC
Core colors BN, BU, GNYE
Core cross-section 3x0.34mm²
Arrangement of strands 19x0.15 mm

Electrical features at +20 °C
Current 4 A
Rated voltage 24 V
Insulation resistance > 1 MΩ/km
Test voltage 2000 V
Forward resistance max. 57 Ω/km

Valve connector BI type
Extension Cable
VIS02-S80E-1,5-RSC5.31T/TEL

Mechanical and chemical properties

Bending radius (stationary laying)	> 5 x Ø
Bending radius (flexible use)	> 10 x Ø
Ambient temperature	
Stationary	-40...+105°C
In motion	0...+80°C