

## Rubber Endstop Buffers · cylindrical

25150.0333



### Product Description

To be used as an elastic end-stop, bearing foot etc.  
The hardness is  $55 \pm 5^\circ$  shore A. Further shore hardnesses ( $40 \pm 5^\circ$  shore A and  $70 \pm 5^\circ$  shore A) on request.

### Material

#### Support washer

- Steel, zinc-plated, blue chromated

#### Threaded bushing

- Steel, zinc-plated, blue chromated

#### Body

- Rubber natural caoutchouc (NR), black

### More information

#### Further products

- Support Legs, Impact cushioning

### Drawing

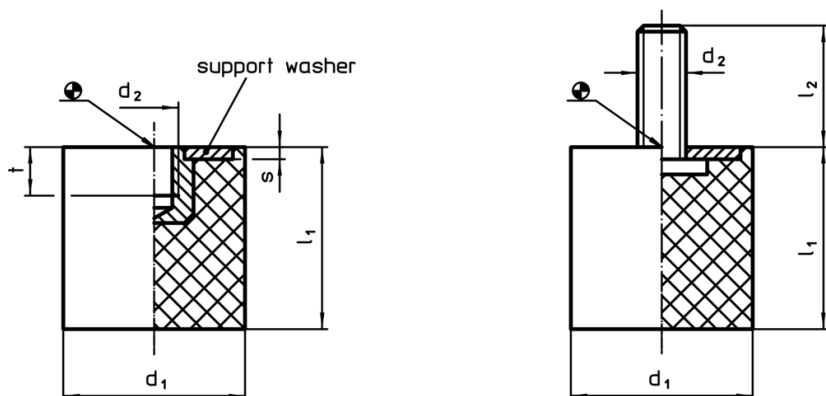

picture 1

picture 2

### Order information

Dimensions					Spring rate R ~ [N/mm]	Load capacity max. [N]	Spring range ~ [mm]	Temperature range		Weight [g]	Art. No.
d <sub>1</sub>	l <sub>1</sub>	d <sub>2</sub>	s	t				min.	max.		
[mm]								[°C]			
with female thread – picture 1, steel											
30	30	M8	2	6.5	117	876	7.5	-30	80	30	25150.0333

### Application example

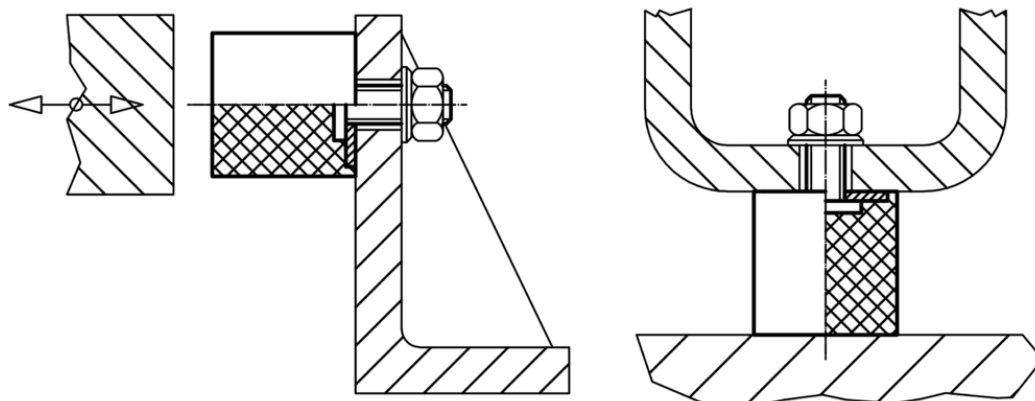

## Compliance

### RoHS compliant

Contains lead - compliant according to exceptions 6a / 6b / 6c

### Contains SVHC substances >0,1% w/w

Contains lead - SVHC list [REACH] as of 10.06.2022

### Contains Proposition 65 substances



Lead can cause cancer and reproductive harm from exposure  
<https://www.P65Warnings.ca.gov/>

### Free from Conflict Minerals

This product does not contain any substances designated as "conflict minerals" such as tantalum, tin, gold or tungsten from the Democratic Republic of Congo or adjacent countries.