

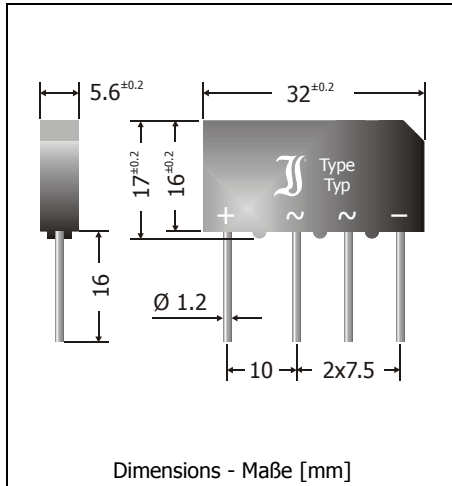

## B...C7000-4000A

### Silicon-Bridge-Rectifiers Silizium-Brückengleichrichter

Version 2012-10-02



Nominal current Nennstrom	7.0 A / 4.0 A
Alternating input voltage Eingangswchelspannung	40...500 V
Plastic case Kunststoffgehäuse	32 x 5.6 x 17 [mm]
Weight approx. – Gewicht ca.	9 g
Plastic material has UL classification 94V-0 Gehäusematerial UL94V-0 klassifiziert	
Standard packaging bulk Standard Lieferform lose im Karton	
Mounting clamp BO2 — Befestigungsschelle BO2	



Recognized Product – Underwriters Laboratories Inc.® File E175067  
Anerkanntes Produkt – Underwriters Laboratories Inc.® Nr. E175067

**Maximum ratings****Grenzwerte**

Type Typ	Max. alternating input voltage Max. Eingangswchelspannung $V_{VRMS}$ [V]	Repetitive peak reverse voltage Periodische Spitzensperrspannung $V_{RRM}$ [V] <sup>1)</sup>
B40C7000-4000A	40	80
B80C7000-4000A	80	160
B125C7000-4000A	125	250
B250C7000-4000A	250	600
B380C7000-4000A	380	800
B500C7000-4000A	500	1000

Repetitive peak forward current Periodischer Spitzenstrom	$f > 15$ Hz	$I_{FRM}$	50 A <sup>2)</sup>
Peak forward surge current, 50/60 Hz half sine-wave Stoßstrom für eine 50/60 Hz Sinus-Halbwell	$T_A = 25^\circ\text{C}$	$I_{FSM}$	250/275 A
Rating for fusing, $t < 10$ ms Grenzlastintegral, $t < 10$ ms	$T_A = 25^\circ\text{C}$	$i^2t$	310 A <sup>2</sup> s
Operating junction temperature – Sperrschichttemperatur Storage temperature – Lagerungstemperatur		$T_j$ $T_s$	-50...+150°C -50...+150°C

1 Valid per diode – Gültig pro Diode

2 Valid, if leads are kept to ambient temperature  $T_A = 50^\circ\text{C}$  at a distance of 5 mm from case  
Gültig, wenn die Anschlussdrähte in 5 mm vom Gehäuse auf Umgebungstemperatur  $T_A = 50^\circ\text{C}$  gehalten werden

**Characteristics**
**Kennwerte**

Max. rectified current without cooling fin Dauergrenzstrom ohne Kühlblech	$T_A = 50^\circ\text{C}$	R-load C-load	$I_{FAV}$ $I_{FAV}$	4.8 A <sup>1)</sup> 4.0 A <sup>1)</sup>
Max. rectified current with cooling fin 300 cm <sup>2</sup> Dauergrenzstrom mit Kühlblech 300 cm <sup>2</sup>	$T_A = 50^\circ\text{C}$	R-load C-load	$I_{FAV}$ $I_{FAV}$	8.0 A 7.0 A
Leakage current – Sperrstrom	$T_j = 25^\circ\text{C}$	$V_R = V_{RRM}$	$I_R$	< 5 $\mu\text{A}$
Thermal resistance junction to ambient air Wärmewiderstand Sperrschicht – umgebende Luft			$R_{thA}$	< 15 K/W <sup>1)</sup>

Type Typ	Max. admissible load capacitor Max. zulässiger Ladekondensator $C_L$ [ $\mu\text{F}$ ]	Min. required protective resistor Min. erforderl. Schutzwiderstand $R_t$ [ $\Omega$ ]
B40C7000-4000A	10000	0.5
B80C7000-4000A	5000	1.0
B125C7000-4000A	2500	2.0
B250C7000-4000A	1500	4.0
B380C7000-4000A	1000	5.0
B500C7000-4000A	800	6.5

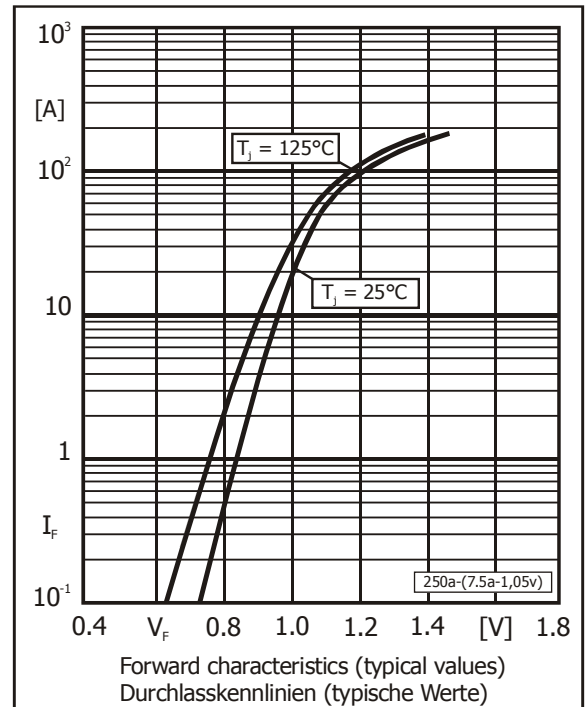
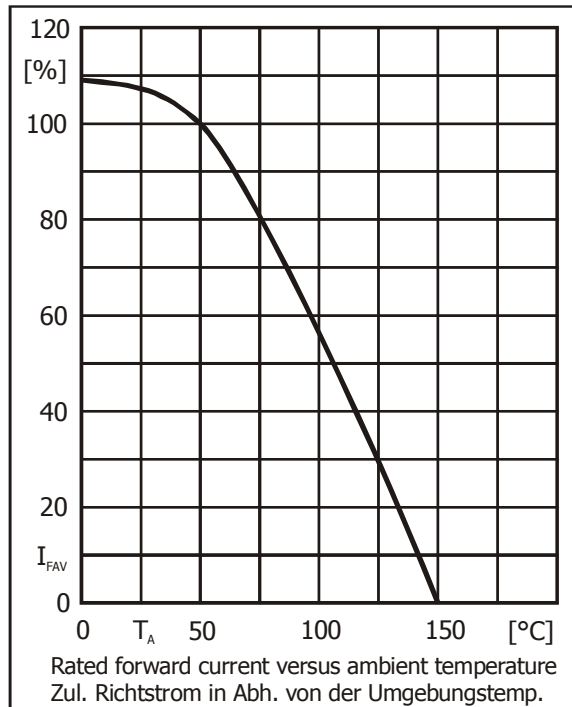

1 Valid, if leads are kept to ambient temperature  $T_A = 50^\circ\text{C}$  at a distance of 5 mm from case  
Gültig, wenn die Anschlussdrähte in 5 mm vom Gehäuse auf Umgebungstemperatur  $T_A = 50^\circ\text{C}$  gehalten werden