

MPS 5/07 S F4 TN B B

Weidmüller Interface GmbH & Co. KG
 Klingenbergstraße 26
 D-32758 Detmold
 Germany

www.weidmueller.com

Product image

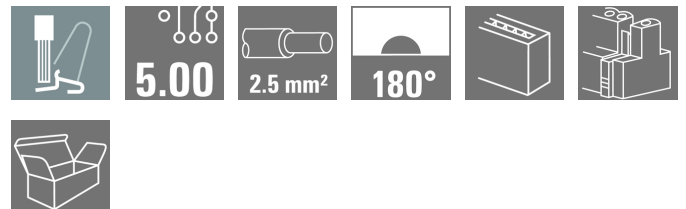

General ordering data

Order No.	2741720000
Type	MPS 5/07 S F4 TN B B
GTIN (EAN)	4064675055242
Qty.	48 Stück
Product data	IEC: 400 V / 26.8 A / 0.5 - 2.5 mm ² UL: 300 V / 18.5 A / AWG 20 - AWG 12/7, AWG12/9
Packaging	Box

Erstellungs-Datum January 29, 2021 3:44:39 AM CET

Katalogstand 15.01.2021 / Technische Änderungen vorbehalten

MPS 5/07 S F4 TN B B

Weidmüller Interface GmbH & Co. KG
 Klingenbergstraße 26
 D-32758 Detmold
 Germany

www.weidmueller.com

Technische Daten

Dimensions and weights

Depth	34 mm	Depth (inches)	1.339 inch
Height	17.5 mm	Height (inches)	0.689 inch
Net weight	17.333 g	Width	35.8 mm
Width (inches)	1.409 inch		

System Parameters

Type of connection	Field connection		
Wire connection method	SNAP IN		
Pitch in mm (P)	5 mm		
Pitch in inches (P)	0.197 inch		
Conductor outlet direction	180°		
Number of poles	7		
Number of rows	1		
Pin series quantity	1		
Touch-safe protection acc. to DIN VDE 57 106	Safe from finger touch		
Touch-safe protection acc. to DIN VDE 0470	IP 20		
Volume resistance	≤5 mΩ		
Stripping length	9 mm		
Stripping length tolerance	min.	8 mm	
	max.	10 mm	
Plugging force/pole, max.	8.5 N		
Pulling force/pole, max.	8.5 N		

Material data

Insulating material	PBT GF	Colour	black
Colour chart (similar)	RAL 9011	Insulating material group	I
Comparative Tracking Index (CTI)	≥ 600	UL 94 flammability rating	V-0
Contact material	CuSn	Contact surface	tinned
Layer structure of plug contact	4...8 μm Sn	Storage temperature, min.	-25 °C
Storage temperature, max.	55 °C	Operating temperature, min.	-50 °C
Operating temperature, max.	100 °C		

Conductors suitable for connection

Clamping range, min.	0.5 mm ²
Clamping range, max.	2.5 mm ²
Wire connection cross section AWG, min.	AWG 20
Wire connection cross section AWG, max.	AWG 14
Solid, min. H05(07) V-U	0.5 mm ²
Solid, max. H05(07) V-U	2.5 mm ²
Flexible, min. H05(07) V-K	0.5 mm ²
Flexible, max. H05(07) V-K	2.5 mm ²
w. plastic collar ferrule, DIN 46228 pt 4, 0.5 mm ² min.	
w. plastic collar ferrule, DIN 46228 pt 4, 2.5 mm ² max.	
w. wire end ferrule, DIN 46228 pt 1, min.	0.5 mm ²
w. wire end ferrule, DIN 46228 pt 1, max.	2.5 mm ²

Erstellungs-Datum January 29, 2021 3:44:39 AM CET

MPS 5/07 S F4 TN B B

Weidmüller Interface GmbH & Co. KG
 Klingenbergstraße 26
 D-32758 Detmold
 Germany

www.weidmueller.com

Technische Daten

Outer diameter of insulation, max.	4 mm		
Clampable conductor	Cross-section for conductor connection	nominal	0.5 mm ²
	wire end ferrule	Stripping length	nominal 12 mm
		Recommended wire-end ferrule	H0.5/16 OR
		Stripping length	nominal 10 mm
		Recommended wire-end ferrule	H0.5/10
	Cross-section for conductor connection	nominal	0.75 mm ²
	wire end ferrule	Stripping length	nominal 12 mm
		Recommended wire-end ferrule	H0.75/16 W
		Stripping length	nominal 10 mm
		Recommended wire-end ferrule	H0.75/10
	Cross-section for conductor connection	nominal	1 mm ²
	wire end ferrule	Stripping length	nominal 12 mm
		Recommended wire-end ferrule	H1.0/16 GE
		Stripping length	nominal 10 mm
		Recommended wire-end ferrule	H1.0/10
	Cross-section for conductor connection	nominal	1.5 mm ²
	wire end ferrule	Stripping length	nominal 12 mm
		Recommended wire-end ferrule	H1.5/16 R
		Stripping length	nominal 10 mm
		Recommended wire-end ferrule	H1.5/10
Cross-section for conductor connection	nominal	2.5 mm ²	
wire end ferrule	Stripping length	nominal 10 mm	
	Recommended wire-end ferrule	H2.5/15D BL	
	Stripping length	nominal 10 mm	
	Recommended wire-end ferrule	H2.5/10	

Reference text The outside diameter of the plastic collar should not be larger than the pitch (P). Length of ferrules is to be chosen depending on the product and the rated voltage.

Rated data acc. to IEC

tested acc. to standard	IEC 60664-1, IEC 61984	
Rated current, max. number of poles (Tu=20°C)	19.7 A	Rated current, min. number of poles (Tu=20°C) 26.8 A
Rated current, max. number of poles (Tu=40°C)	16.9 A	Rated current, min. number of poles (Tu=40°C) 23.1 A
Rated voltage for surge voltage class / pollution degree III/2	320 V	Rated voltage for surge voltage class / pollution degree II/2 400 V
Rated impulse voltage for surge voltage class/ pollution degree II/2	4 kV	Rated voltage for surge voltage class / pollution degree III/3 250 V
Rated impulse voltage for surge voltage class/ contamination degree III/3	4 kV	Rated impulse voltage for surge voltage class/ pollution degree III/2 4 kV

MPS 5/07 S F4 TN B B

Weidmüller Interface GmbH & Co. KG
 Klingenbergstraße 26
 D-32758 Detmold
 Germany

www.weidmueller.com

Technische Daten

Rated data acc. to UL 1059

Institute (cURus)



Certificate No. (cURus)

E60693

Rated voltage (Use group B / UL 1059)	300 V
Rated current (Use group B / UL 1059)	18.5 A
Wire cross-section, AWG, min.	AWG 18
Reference to approval values	Specifications are maximum values, details - see approval certificate.

Rated voltage (Use group D / UL 1059)	300 V
Rated current (Use group D / UL 1059)	10 A
Wire cross-section, AWG, max.	AWG 14

Classifications

ETIM 6.0	EC002638	ETIM 7.0	EC002638
ECLASS 9.0	27-44-03-09	ECLASS 9.1	27-44-03-09
ECLASS 10.0	27-44-03-09	ECLASS 11.0	27-46-02-02

Important note

IPC conformity

Conformity: The products are developed, manufactured and delivered according international recognized standards and norms and comply with the assured properties in the data sheet resp. fulfill decorative properties in accordance with IPC-A-610 "Class 2". Further claims on the products can be evaluated on request.

Notes

- Rated current related to rated cross-section & min. No. of poles.
- P on drawing = pitch
- Rated data refer only to the component itself. Clearance and creepage distances to other components are to be designed in accordance with the relevant application standards.
- Wire end ferrule without plastic collar to DIN 46228/1

Approvals

Approvals



UL File Number Search E60693

Downloads

Engineering Data [STEP](#)

MPS 5/07 S F4 TN B B

Weidmüller Interface GmbH & Co. KG
 Klingenbergstraße 26
 D-32758 Detmold
 Germany

www.weidmueller.com

Zeichnungen

Product image

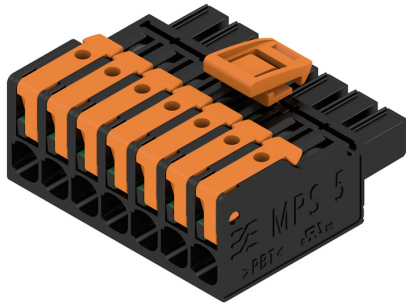

Dimensional drawing

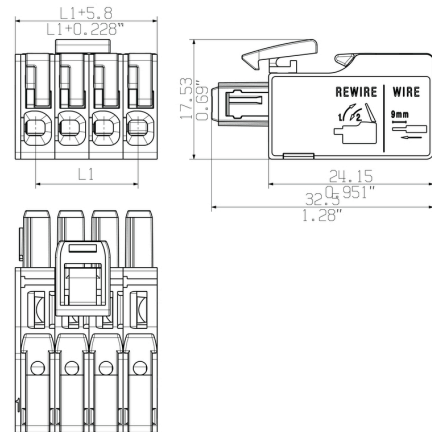

Derating curve

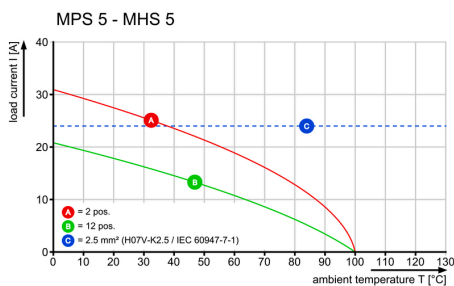

Product benefits



Fastest connection technology SNAP IN

Product benefits



Acoustic and visual feedback

Product benefits

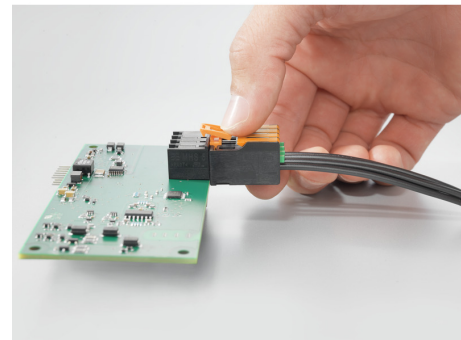

Easy one-handed use of top-fixation

Allgemeinguetlige Kundenzeichnung, aktueller Stand nur auf Anfrage
 General customer drawing, topical version only if required

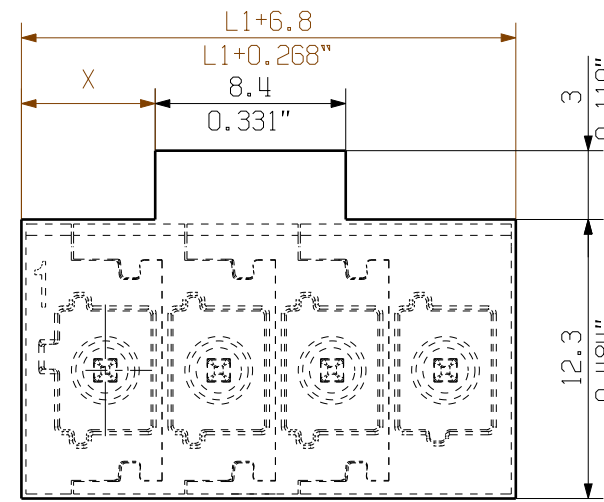
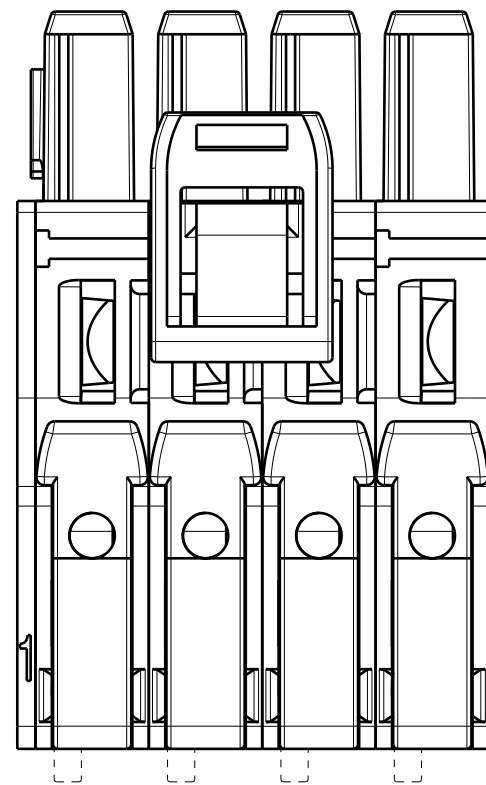
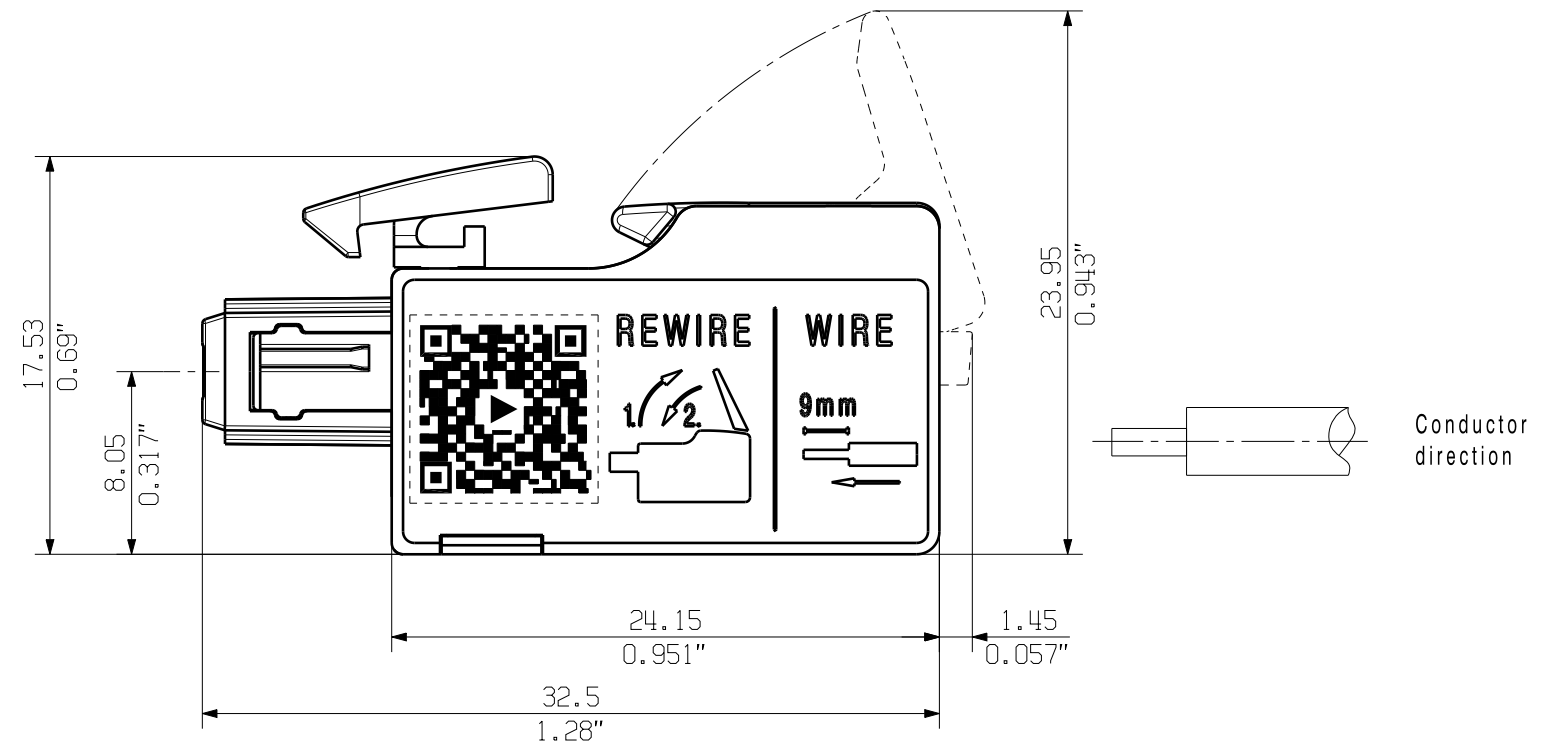
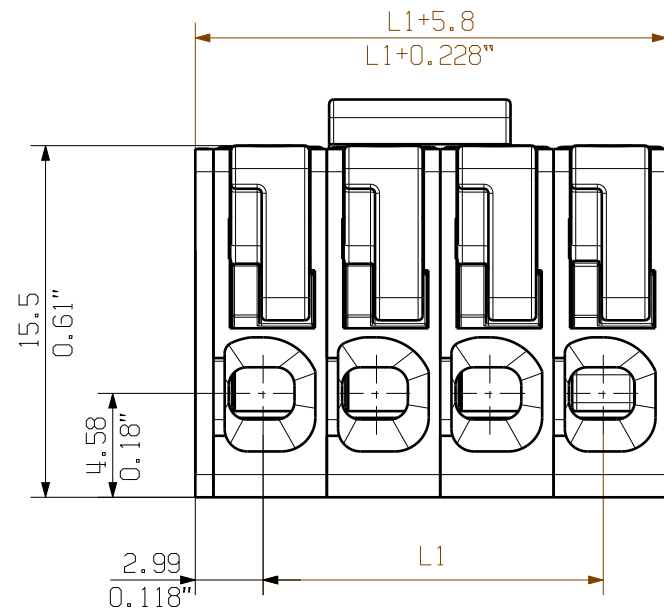

Min. front plate cut-out

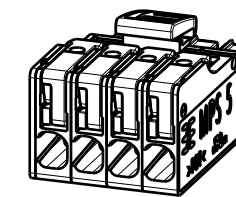

M 1/1

Further dim. & info. see data sheet

General tolerance:
 DIN ISO 2768-mK

12	55.00	2.165	25.90	1.020
11	50.00	1.969	25.90	1.020
10	45.00	1.772	20.90	0.823
9	40.00	1.575	20.90	0.823
8	35.00	1.378	15.90	0.626
7	30.00	1.181	15.90	0.626
6	25.00	0.984	10.90	0.429
5	20.00	0.787	10.90	0.429
4	15.00	0.591	5.90	0.232
3	10.00	0.394	5.90	0.232
2	5.00	0.197	0.90	0.035
n Poles	L1 [mm]	L1 [inch]	X [mm]	X [inch]

For the mounting of PCBs, it should be noted that the rated data given in the catalogue relates only to the connection elements. The necessary creepage and clearance paths must be observed in connection with the respective applicant in accordance with VDE 0110. The current-carrying capacity and pitch tolerance is to be determined according to DIN IEC 326 part 3 very fine.

Weidmueller connectors are tested to the DIN VDE 0627 standard, and are valid for its field of application. Provided that the connectors are used to the intended purpose, all requirements with respect to the occurring of electrical, mechanical, thermic and corrosive stress will be satisfied.

	EC00004370 P028441	Prim PLM Part No.: .	Prim ERP Part No.: .
	First Issue Date 07.05.2020	Max. nos.	
	Modification	72561 Drawing no. Issue no. Sheet 6 of 8 sheets	
	Drawn	Date	MPS 5/... TN ... BUCHSENSTECKER FEMALE PLUG
	Responsible	Name	
Scale: ./.	Size: A3	Approved	Product file: