



ERINOME-II EVALUATION BOARD MANUAL

FOR RADIO MODULES

EV Order Code	Module order code	Marketing Name
2614029237001 2614029237011	2614021137000	Erinome-II

VERSION 1.5

NOVEMBER 9, 2020

Revision history

Manual version	HW version	Notes	Date
1.0	2.1	<ul style="list-style-type: none"> Initial version 	February 2020
1.1	2.1	<ul style="list-style-type: none"> Jumper table JP3 updated 	March 2020
1.2	2.1	<ul style="list-style-type: none"> Jumper table JP3 updated Chapter 3.4.15 added 	June 2020
1.3	2.1	<ul style="list-style-type: none"> Added Chapter 4: putting into operation. For Chapter 4.1, content was moved from Chapter 2. Corrected block diagram in Chapter 3 Updated product image in Chapter 1 Added table 3.2 Updated section 3.4.5 Updated section 3.4.13 	July 2020
1.4	2.1	<ul style="list-style-type: none"> Added Chapter 4.3 : Putting into operation - SPI. 	October 2020
1.5	2.1	<ul style="list-style-type: none"> Released Thyone-I RF interface and battery operation 	November 2020

Abbreviations and abstract

Abbreviation	Name	Description
BDS	BeiDou navigation System	Chinese satellite navigation system
COM	Communication	
CS	Chip Select	
CTS	Clear to send	
ESD	Electro Static Discharge	
FTDI	Future Technology Devices International	
Galileo		European satellite navigation system
GLONASS	Global Navigation Satellite System	Russian satellite navigation system
GNSS	Global Navigation Satellite System	
GPS	Global Positioning System	American satellite navigation system
HIGH	High signal level	
I ² C	Inter-Integrated Circuit	
IO	Input Output	
LDO	Low-dropout	Linear voltage regulator
LED	Light Emitting Diode	
LOW	Low signal level	
MISO	Master Input, Slave Output	
MOSI	Master Output, Slave Input	
PC	Personal Computer	
RC	Resistor Capacitor	
RF	Radio frequency	Describes everything relating to the wireless transmission.
RTS	Request to send	
RST	Reset	
SCL	Serial Clock Line	
SCLK	Serial Clock	
SDA	Serial Data Line	
SPI	Serial Peripheral Interface	
SWDCLK	Serial Wire Debug Clock	

Abbreviation	Name	Description
UART	Universal Asynchronous Receiver Transmitter	Universal Asynchronous Receiver Transmitter allows communicating with the module of a specific interface.
USB	Universal Serial Bus	
VCC	Supply voltage	

Contents

1	Supported radio modules	6
2	Functional description	8
3	Development board	9
3.1	Block diagram	9
3.2	Jumpers	10
3.3	Connectors	13
3.3.1	CON1	14
3.3.2	CON2	14
3.3.3	CON3	14
3.3.4	CON4 (only for 2614029237011)	15
3.4	Switches and Buttons	16
3.4.1	RESET GNSS button	17
3.4.2	ON/OFF Switch	17
3.4.3	RESET_RF button (only for 2614029237011)	17
3.4.4	WAKE-UP_RF button (only for 2614029237011)	17
3.4.5	Power supply	18
3.4.5.1	Bus powered, power supply through USB	18
3.4.5.2	Battery powered, power supply through AAA battery (only for 2614029237011)	18
3.4.6	JP1 - Current Measurement	18
3.4.7	JP2 - UART Communication Interface Selection	18
3.4.8	JP3 - Communication Interface	18
3.4.9	JP4 - Antenna Selection	18
3.4.10	JP5 - Active Antenna Bias	19
3.4.11	JP6 - CTS/RTS Pull Resistors	19
3.4.12	JP7 (only for 2614029237011)	19
3.4.13	JP8 (only for 2614029237011)	19
3.4.14	UART / USB	19
3.4.15	LED - Erinome-II GNSS module	19
3.4.15.1	STATUS GNSS LED	19
3.4.15.2	1PPS GNSS LED	20
3.4.15.3	TX GNSS LED	20
3.4.16	LED - Thyone-I radio module (only for 2614029237011)	20
3.4.16.1	BUSY_RF and RF_ST1 LED	20
3.4.17	Proprietary RF Block	20
3.5	Schematic	21
3.6	Layout	24
4	Putting into operation	26
4.1	Putting into operation - UART	26
4.1.1	Putting into operation - UART with Thyone-I proprietary RF module (only for 2614029237011)	28
4.2	Putting into operation - I ² C	30
4.2.1	Hardware Setup - Erinome-II	30
4.2.2	Evaluation Board Modification - Erinome-II	31

4.3	Putting into operation - SPI	33
4.3.1	Hardware Setup - SPI	33
4.3.2	Evaluation Board Setup - SPI	34
5	Regulatory compliance information	36
5.1	Exemption clause	36
6	Important notes	37
6.1	General customer responsibility	37
6.2	Customer responsibility related to specific, in particular safety-relevant applications	37
6.3	Best care and attention	37
6.4	Customer support for product specifications	37
6.5	Product improvements	38
6.6	Product life cycle	38
6.7	Property rights	38
6.8	General terms and conditions	38
7	Legal notice	39
7.1	Exclusion of liability	39
7.2	Suitability in customer applications	39
7.3	Trademarks	39
7.4	Usage restriction	39
8	License terms	41
8.1	Limited license	41
8.2	Usage and obligations	41
8.3	Ownership	42
8.4	Firmware update(s)	42
8.5	Disclaimer of warranty	42
8.6	Limitation of liability	43
8.7	Applicable law and jurisdiction	43
8.8	Severability clause	43
8.9	Miscellaneous	43

1 Supported radio modules

The evaluation board is exclusively for the Erinome-II module:

Order code	Product Name	Description
2614021137000	Erinome-II	GNSS Module supporting GPS, Galileo, BeiDou and GLONASS Navigation Systems

Order code	Description
2614029237001	Erinome-II module EV-Kit
2614029237011	Erinome-II module EV-Kit with Thyone-I RF interface

Table 1: Compatibility

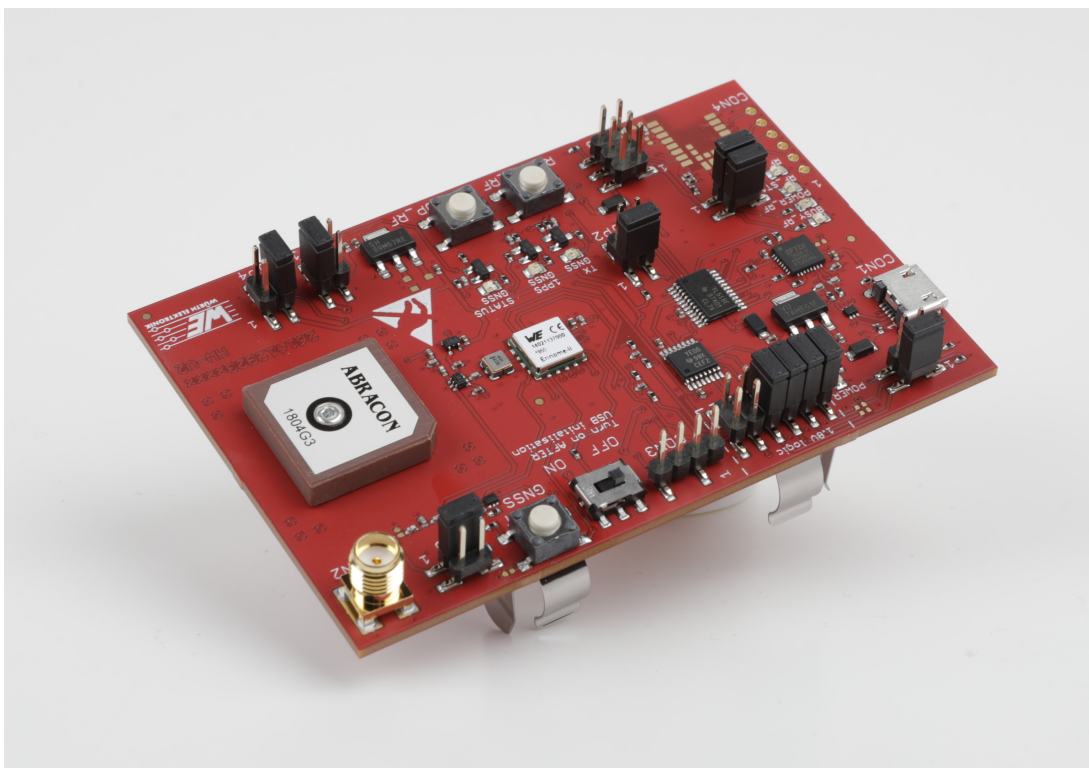

Figure 1: 2614029237001 - product image

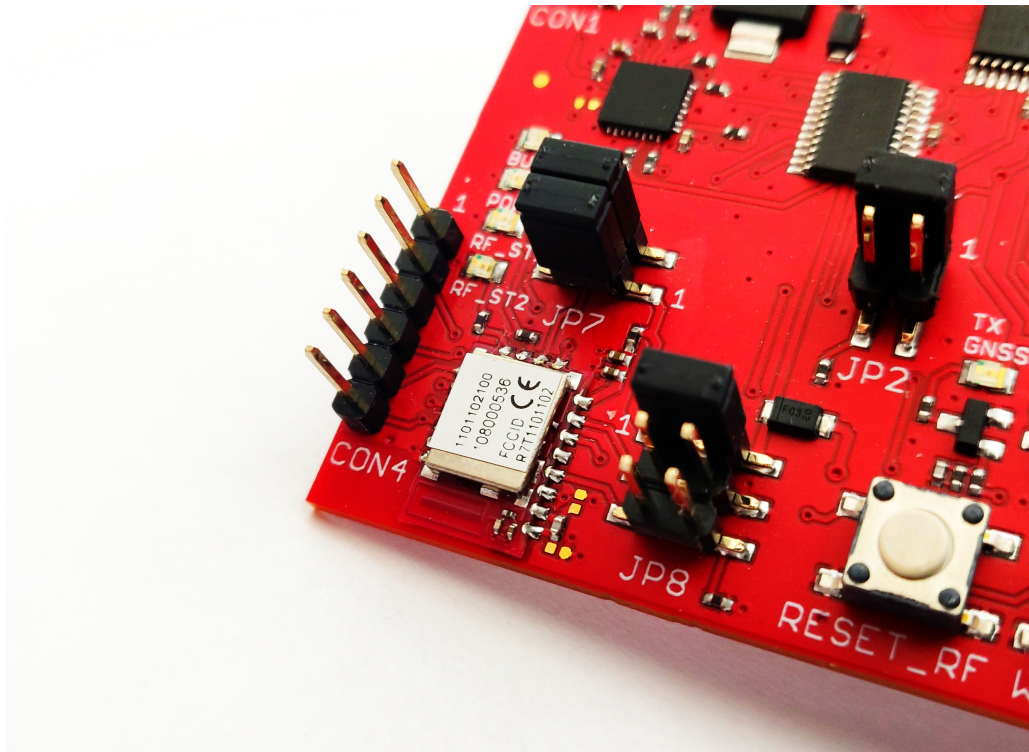

Figure 2: 2614029237011 - detail of the Thyone-I RF interface

Kit Content 2614029237001	Quantity
Evaluation board with Erinome-II	1
USB2 A to USB Micro cable	1
External active antenna	1
Packaging: Cardboard Box, ESD bag	1

Table 2: Content Erinome-II module EV-Kit

Kit Content 2614029237011	Quantity
Evaluation board with Erinome-II and Thyone-I	1
USB2 A to USB Micro cable	1
Thyone-I USB radio stick	1
Packaging: Cardboard Box, ESD bag	1

Table 3: Content Erinome-II module EV-Kit with Thyone-I RF interface



Batteries are not included in the evaluation kit

2 Functional description

The evaluation board offers the user the possibility to put the compatible GNSS module into operation and to evaluate its features. Furthermore, it represents our reference design for the integration of the compatible GNSS module in an application board.

The evaluation board can be connected to an USB port of a PC. For the connection to a microcontroller system the development board is equipped with a multi-pin connector which gives access to all necessary pins of the GNSS module. Jumpers allow the module to be disconnected from components such as the USB interface which are not required.

In the version with the Thyone-I RF interface (part number 2614029237011), the radio module Thyone-I (on the evaluation board) and the corresponding USB radio stick (available in the evaluation kit) can be used to communicate with the GNSS module through RF link, instead of USB cable. In this setup, batteries can be used to supply the evaluation board, making it completely standalone.

3 Development board

3.1 Block diagram

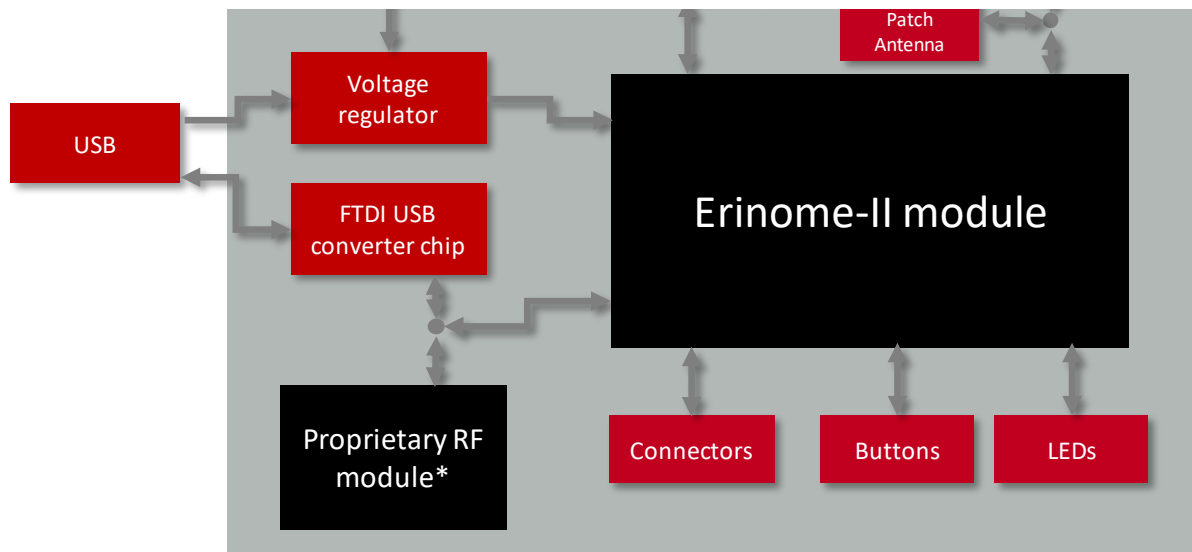

*only in part number 2614029237011

Figure 3: Block diagram

3.2 Jumpers

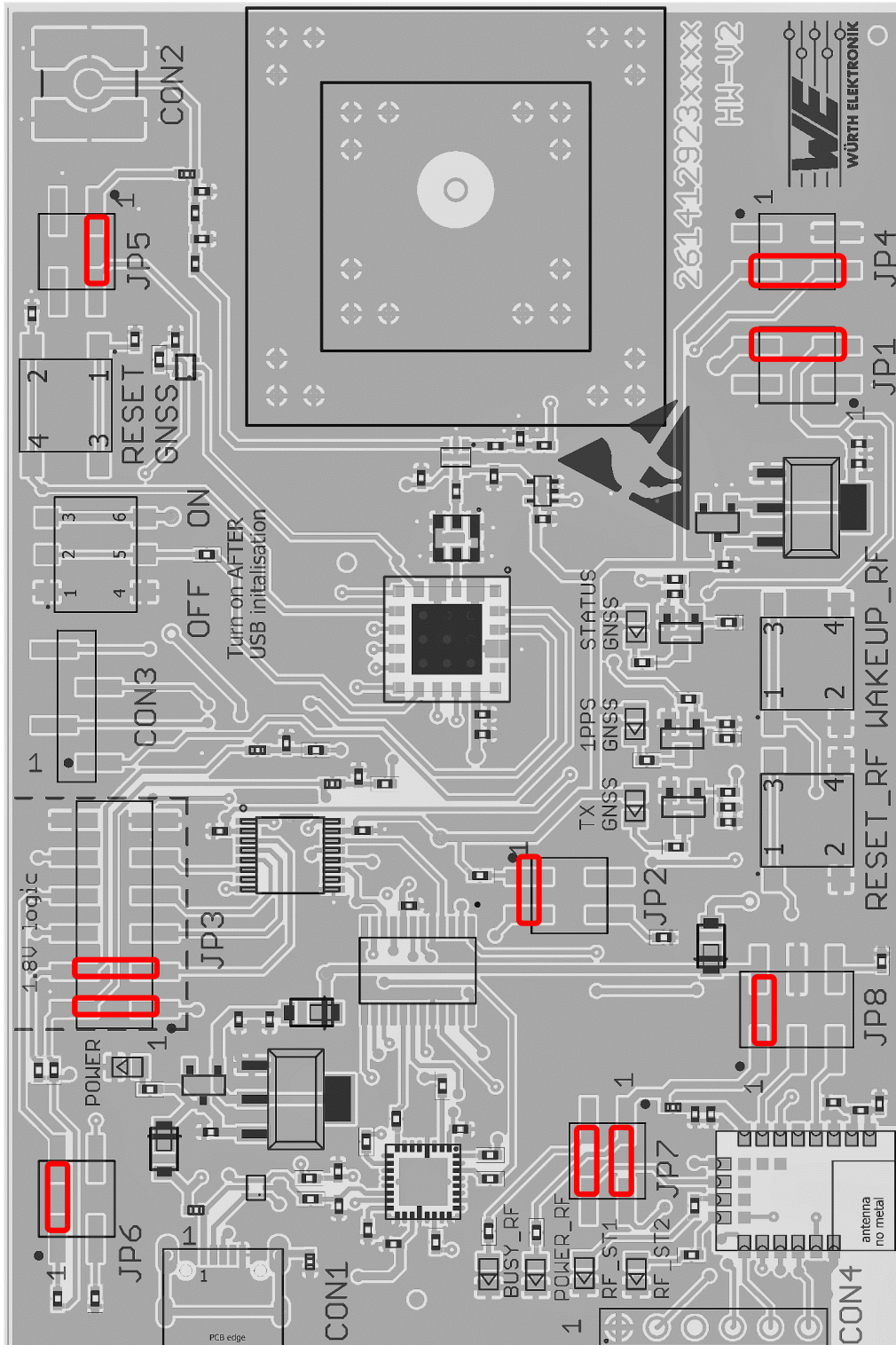

Figure 4: Jumpers, defaults

JP1	Function	Jumper set (default)
1,2	No connection	No
3,4	Power bridge (remove for current measurement)	Yes

JP2	Function	Jumper set (default)
1,3	UART to USB communication	Yes
3,4	UART to proprietary RF communication	No

JP3	Function	Jumper set (default)
1,2	RX UART interface to TX-GNSS module	Yes
3,4	TX UART interface to RX-GNSS module	Yes
5,6	CTS UART interface to RTS-GNSS module	No
7,8	RTS UART interface to CTS-GNSS module	No
9,10	RST-control interface to RST-GNSS module	No
11,12	Ground connection	No

JP4	Function	Jumper set (default)
2,4	Active antenna	No
3,4	Passive antenna	Yes

JP5	Function	Jumper set (default)
1,2	Active antenna bias	Yes
3,4	No connection	No

JP6	Function	Jumper set (default)
1,2	CTS pullup	Yes
3,4	RTS pulldown	No

JP7	Function	Jumper set (default)
1,2	Mode set (only for 2614029237011)	Yes
3,4	Busy LED (only for 2614029237011)	Yes

JP8	Function	Jumper set (default)
1,2	Thyone-I power supply (only for 2614029237011)	No
3,4	Pulldown BOOT_RF (only for 2614029237011)	No
5,6	Pulldown SWDCLK_RF (only for 2614029237011)	No

3.3 Connectors

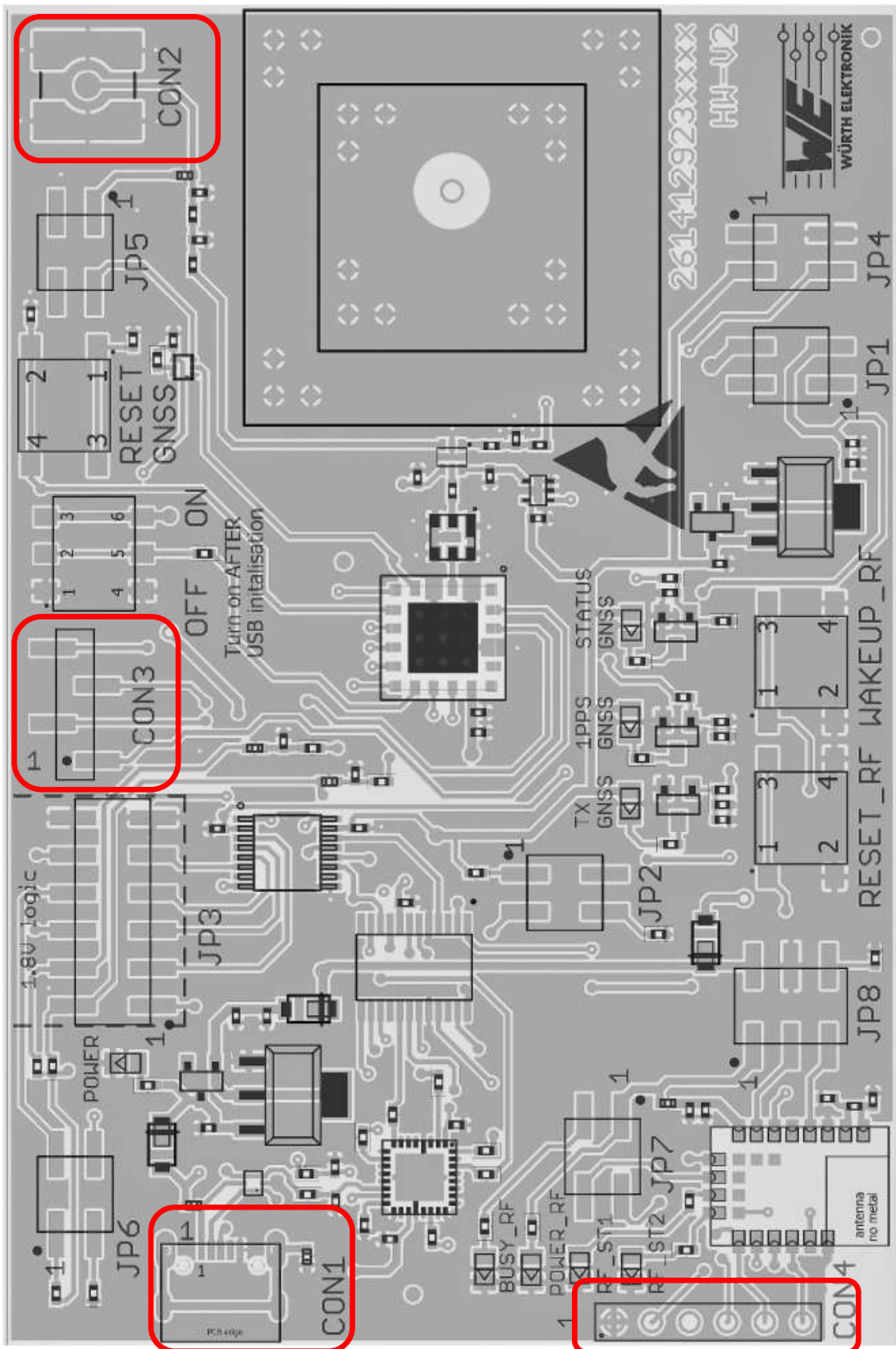

Figure 5: Connectors

Connector	Function
CON1	Micro-USB connector for host connection and VCC bus supply
CON2	SMA connector for external active antenna
CON3	GPIO Connection to the GNSS Module
CON4	UART interface Thyone-I module (only for 2614029237011)

3.3.1 CON1

Connector CON1 is a micro-USB socket that enables connection to PC via standard micro-USB cable and also provides supply voltage to the board during USB powered operation.

CON1	Function
	Micro-USB connector for host connection and VCC bus supply

3.3.2 CON2

Connector CON2 (SMA Jack) is used to connect an external antenna.



In order use the external active antenna, Jumper JP4 and jumper JP5 has to be set according to the jumper table



In order use the on-board passive antenna, Jumper JP4 has to be set according to jumper table and connector CON2 should be left open

CON2	Function
Inner	RF signal
Outer	GND

3.3.3 CON3

Connector CON3 is used to access available GPIO Pins of the Module.

CON3	Function
1	GPIO_C
2	GPIO_B
3	GPIO_8
4	GPIO_2

3.3.4 CON4 (only for 2614029237011)

Connector CON4 is a standard 2.54mm pin header which is used as the UART interface for the Thyone-I module.

CON4	Function
1	GND
2	RTS_RF signal
3	Not connected
4	RX_RF signal
5	TX_RF signal
6	CTS_RF signal

3.4 Switches and Buttons

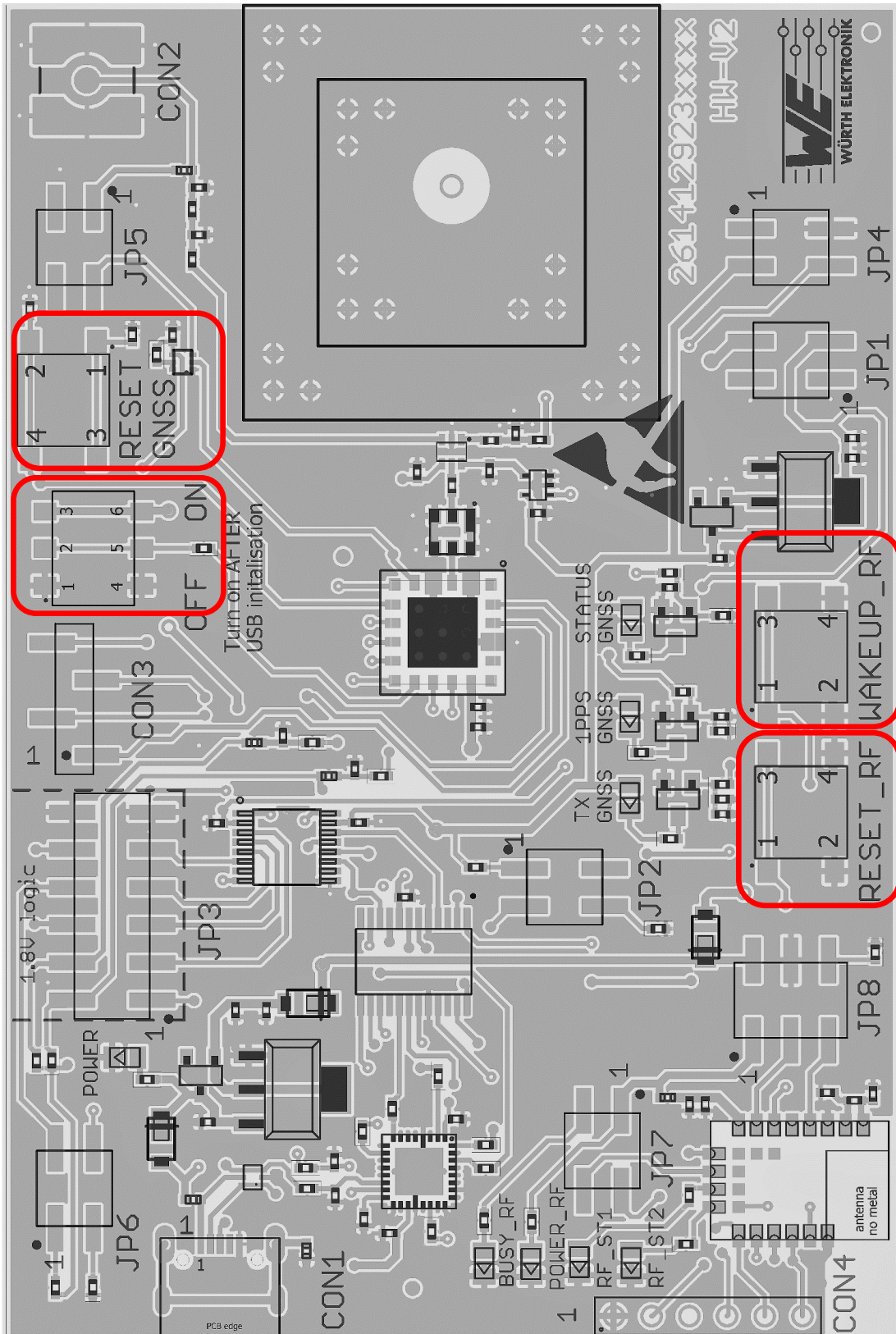

Figure 6: Switches and Buttons

3.4.1 RESET GNSS button

Internally the active low reset input of the Erinome-II is connected via a RC combination with the power supply to ensure a proper startup of the module. */RESET* pin is connected to this button which provides the possibility for hard reset. Please refer to the module specific manual for detailed information.

3.4.2 ON/OFF Switch

ON/OFF Switch is connected to the GNSS module's *ON_OFF* pin. This gives the user the possibility to switch between the operating modes. Please refer to the module specific manual for detailed information.



Before connecting the evaluation board to the PC the ON/OFF switch should be in OFF position (Hibernate mode), only after USB initialisation the ON/OFF switch should be switch to ON position (Full power mode)

3.4.3 RESET_RF button (only for 2614029237011)

Internally the active low reset input of the Thyone-I radio module is connected via a RC combination with the power supply to ensure a proper startup of the module. The module provides a */RESET* pin that is connected to this button so the module can be restarted properly. The module provides an internal pull-up resistor. Please refer to the module specific manual for detailed information.

3.4.4 WAKE-UP_RF button (only for 2614029237011)

The Thyone-I radio module uses the wake-up button connected to the *WAKE-UP* pin to exit from sleep mode of the module. Please refer to the module specific manual for detailed information.

3.4.5 Power supply

3.4.5.1 Bus powered, power supply through USB

The development board can be powered through the micro USB connector. The integrated voltage regulator regulates the connected USB voltage of typ. 5V down to 3V and further a dedicated voltage regulator is used to power the module with the proper voltage supply of 1.8V. If the evaluation board is power sourced the *Power LED* lights up.

3.4.5.2 Battery powered, power supply through AAA battery (only for 2614029237011)

The development board also has optional assembly for battery holders on the bottom to connect two AAA batteries.

3.4.6 JP1 - Current Measurement

By default, JP1 is set to normal operation. If a current meter is connected in place of the jumper, the power consumption of the radio module can be measured.

If the meter is not attached and the bridge is not set, the module will not receive a supply voltage. However, the *Power LED* may be active, as it is connected prior to the current measurement bridge in order not to distort the module's power consumption.

3.4.7 JP2 - UART Communication Interface Selection

By default, JP2 is bridged for UART communication through USB interface.

In part number 2614029237011, the proprietary RF module provides the possibility to support UART communication through radio, which can be established by setting the JP2 to connect pins 3-4 instead of the default 1-3.

3.4.8 JP3 - Communication Interface

By default, JP3 is bridged between the TX, RX, CTS, RTS, Reset lines of GNSS module to UART communication interface. In this setting only TX and RX connections are absolute necessity for UART communication. CTS, RTS and Reset connections are optional and provide the possibility to control the relevant module pins using UART interface.

Pins 2, 4, 6 and 8 of the JP3 can also be used to connect GNSS module to any other external interface instead of bridging the jumper JP3. In such case, beware of IO level compatibility as these pins have a IO logic level of 3.3V. The host must obey the values stated in the module's manual. Especially the IO level restrictions must be implemented by a host system (i.e. using a level shifter to support the allowed IO levels).

3.4.9 JP4 - Antenna Selection

By default, JP4 is bridged to select the passive patch antenna on the evaluation board, the jumper setup can be modified according to the jumper table to select the SMA connector for external active antenna connection.

3.4.10 JP5 - Active Antenna Bias

By default, JP5 is bridged to bias active antenna connected to SMA connector.

3.4.11 JP6 - CTS/RTS Pull Resistors

By default, JP6 is bridged to provide external pullup on CTS of the GNSS module to support UART communication interface. For detailed information related to the setup of pull resistors please refer to the module Manual.

3.4.12 JP7 (only for 2614029237011)

JP7 is used to set the radio module Thyone-I to normal operation mode and to connect a LED for visualization. By default, both jumpers are set.

3.4.13 JP8 (only for 2614029237011)

By default, the jumper JP8 is set to supply the Thyone-I radio module. The other jumpers on JP8 are for internal use only.

3.4.14 UART / USB

UART interface of the module can be connected to the USB converter by setting the jumper JP2 and JP3 accordingly. By default, communication takes place through the USB jack. Using the FTDI-driver the PC tool will show a virtual COM-Port which can be used to communicate with the module.



The USB cable length should not exceed 3 meters.

3.4.15 LED - Erinome-II GNSS module

There are three LEDs available on the evaluation board dedicated to indicate the status of Erinome-II module's functions.

3.4.15.1 STATUS GNSS LED

STATUS GNSS LED is connected to the *WAKE_UP* pin of the Erinome-II module. If the LED is in steady ON state, it indicates that the module is in full power mode. If the LED is in steady OFF state, it indicates that the module is in hibernate mode. Please refer to the module manual for detailed information.

3.4.15.2 1PPS GNSS LED

1PPS GNSS LED is connected to the *1PPS* pin of the Erinome-II module. *1PPS GNSS LED* is triggered through 1PPS signal pulse once the module obtains 3D position fix. Please refer to the module manual for detailed information.

3.4.15.3 TX GNSS LED

TX GNSS LED is connected to the *TX* pin of the Erinome-II module. If the LED is in steady OFF state, it indicates that the module is in hibernate mode. If the LED is in blinking state, it indicates that the module in full power mode and GNSS messages are transmitted by the module. Please refer to the module manual for detailed information.

If the *RESET_GNSS* button on the evaluation board is pressed, the GNSS message transmission is stopped but the *TX GNSS LED* is in steady ON state, this is because of the pull up on TX line by the level shifter used in the evaluation board.

3.4.16 LED - Thyone-I radio module (only for 2614029237011)

3.4.16.1 BUSY_RF and RF_ST1 LED

These LEDs indicate that a radio link between the Thyone-I module on the evaluation board and a partner radio device (e.g. a Thyone-I USB plug) is established and data exchange is taking place.

3.4.17 Proprietary RF Block

In part number 2614029237011, the evaluation board is ready to use the proprietary RF-Module *Thyone-I* for UART communication through a radio interface.

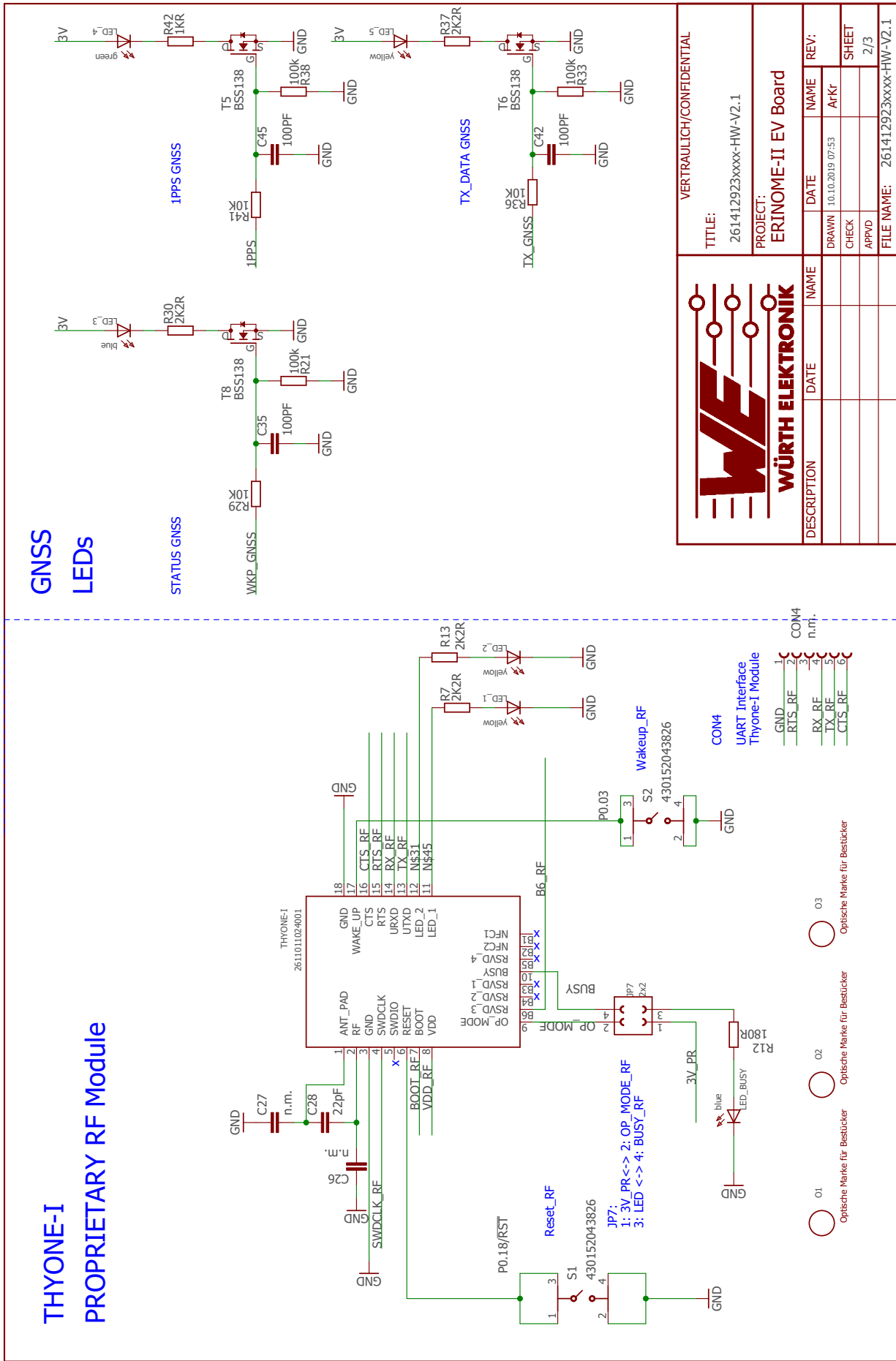

		TITLE: 261412923xxxx-HW-V2.1	
		PROJECT: ERINOME-II EV Board	
DESCRIPTION	DATE	NAME	REV:
	10.10.2019 07:53	ArKr	
CHECK			SHEET
APVD			2/3
			FILE NAME: 261412923xxxx-HW-V2.1

Figure 8: Schematic sheet-2

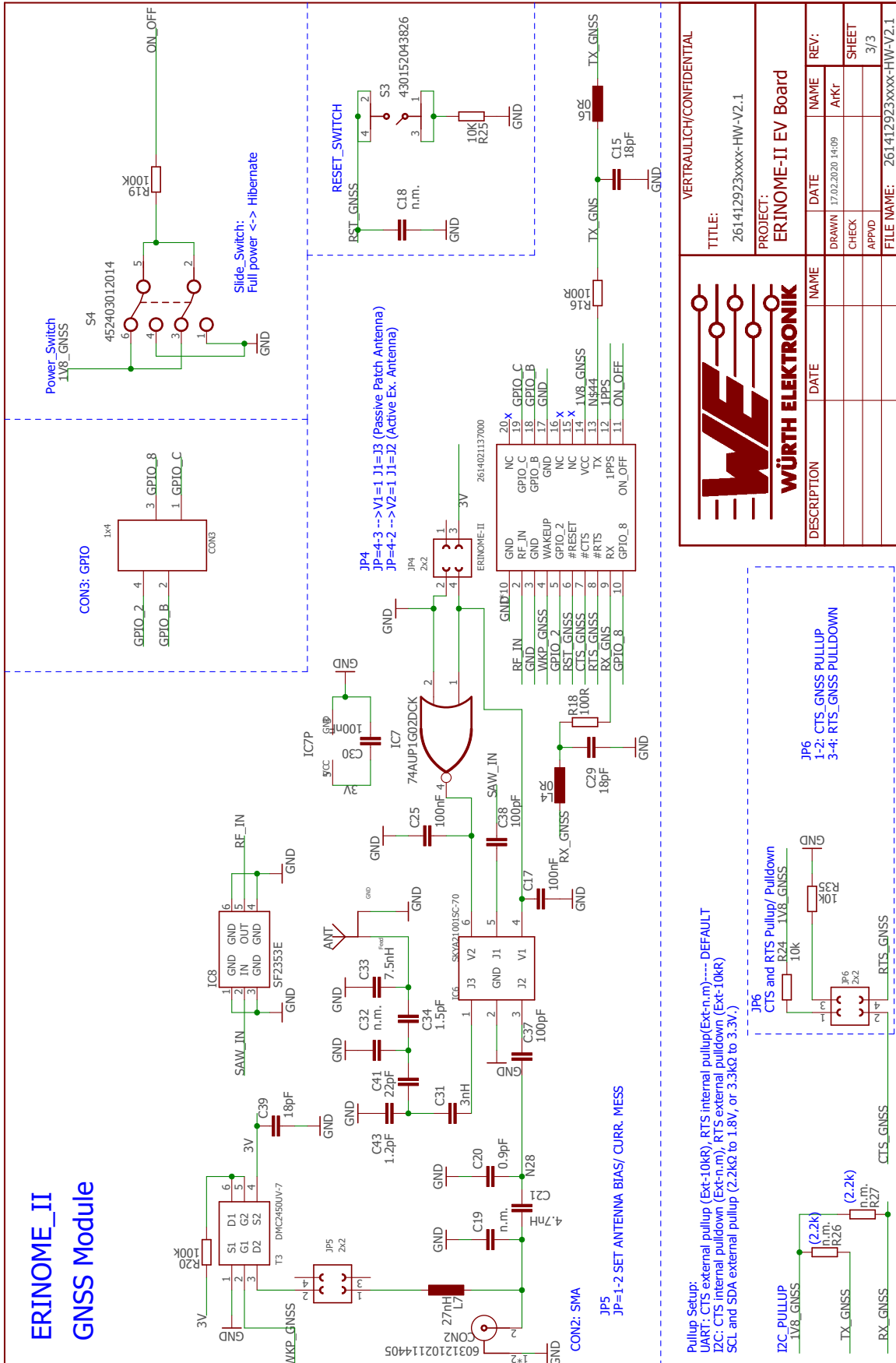

3.6 Layout

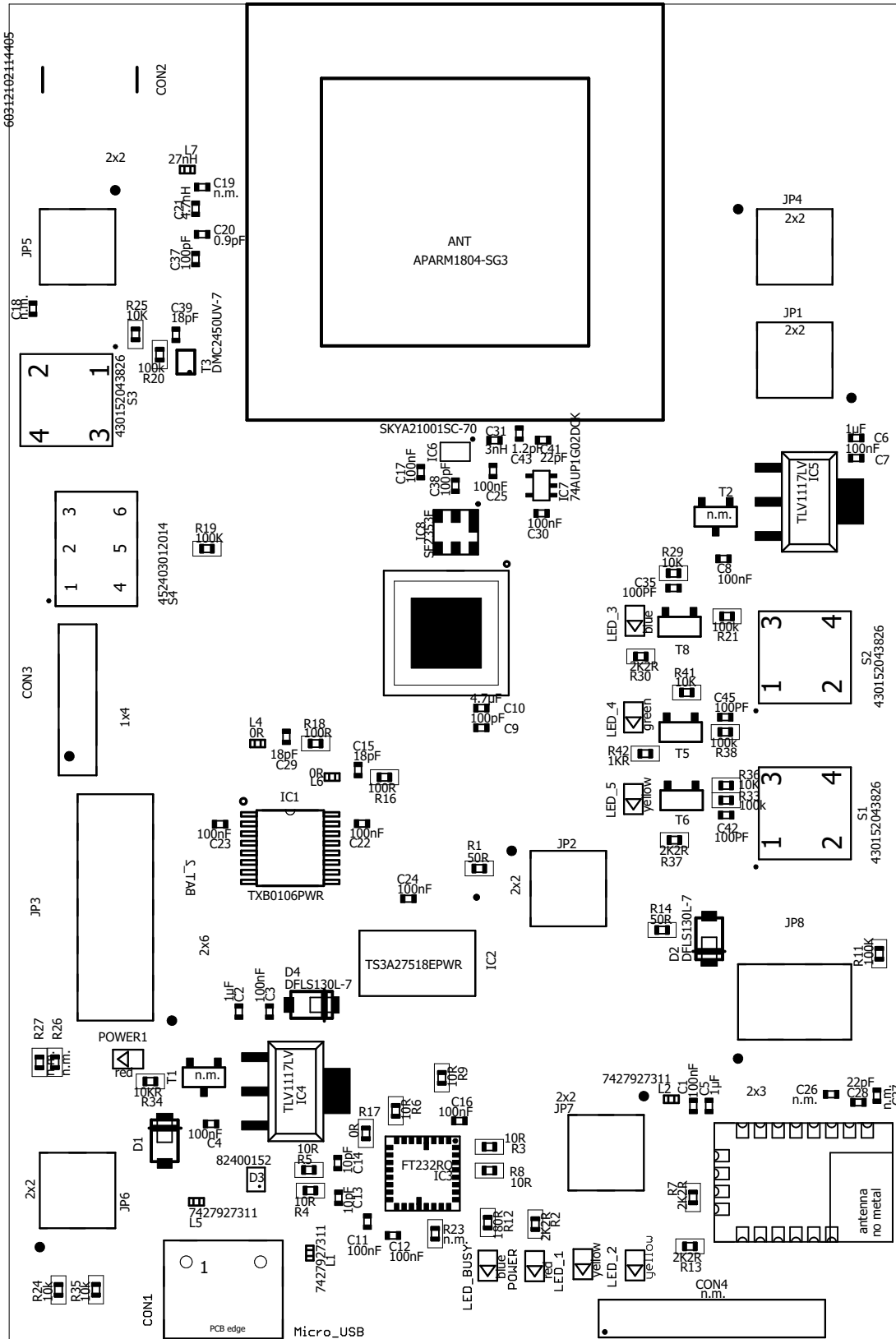

Figure 10: Assembly diagram

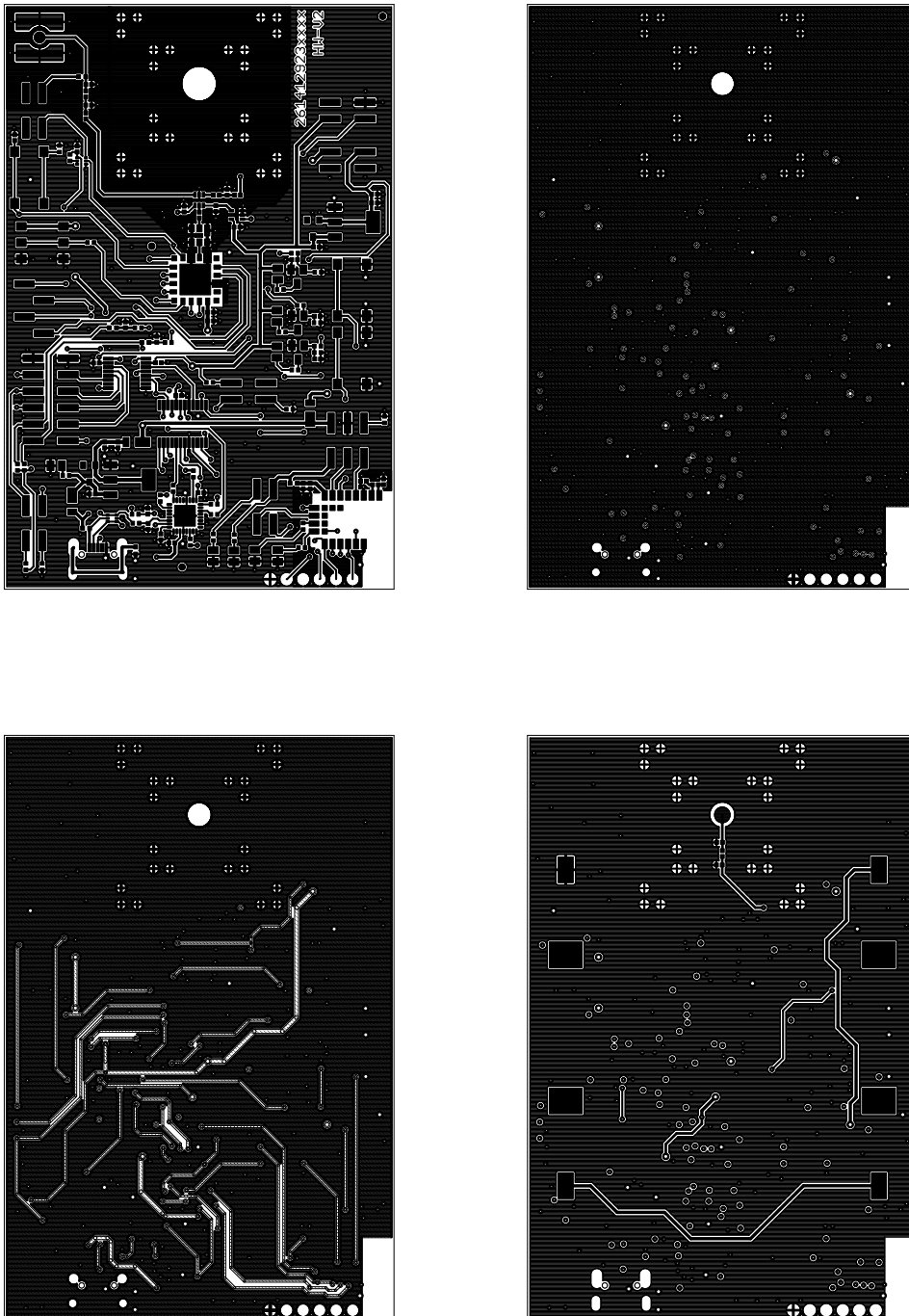

Figure 11: Top,bottom & internal layers

4 Putting into operation

4.1 Putting into operation - UART

Before starting to work with the evaluation board make sure that:

- The jumpers on the EV board are placed on the default locations.
- ON/OFF GNSS switch is in 'OFF' position.
- FTDI driver package is installed on the PC. The latest version of the drivers can be downloaded from (www.ftdichip.com/Drivers/VCP.htm). Please use the setup executable package or follow the install instructions from FTDI.
- Evaluation board is connected to the PC via USB-cable provided in the evaluation kit.
- Module power supply (VCC) is stable and able to reliably supply the module's static and peak current consumption as specified by the module manual.
- COM port is detected and installed on the PC. The (COM) port name of the evaluation board can be found using the device manager on Windows and the display message (dmesg) on Linux. For example, the evaluation board might appear similar to "COM12" on windows and "/dev/ttyUSB0" on Linux. Once the COM port is detected, USB initialisation is completed.
- Switch the ON/OFF GNSS Button to 'ON' position to switch the module from hibernate to full power state. Please make sure to do this only after the USB initialisation. Switching to 'ON' position before USB initialisation, can cause the PC Device Manager to interpret the GNSS module as Microsoft serial ballpoint mouse. In such event, disconnect the board from the PC and repeat the steps.
- WENSS PC-tool can be used to take the evaluation board into operation and communicate with the module. Once connection to the evaluation board is properly established, flow of messages from the GNSS module should be visible in the PC-tool. Please refer to the PC-Tool manual for detailed information.

Please refer to the module reference manual to get the detailed module specific information.

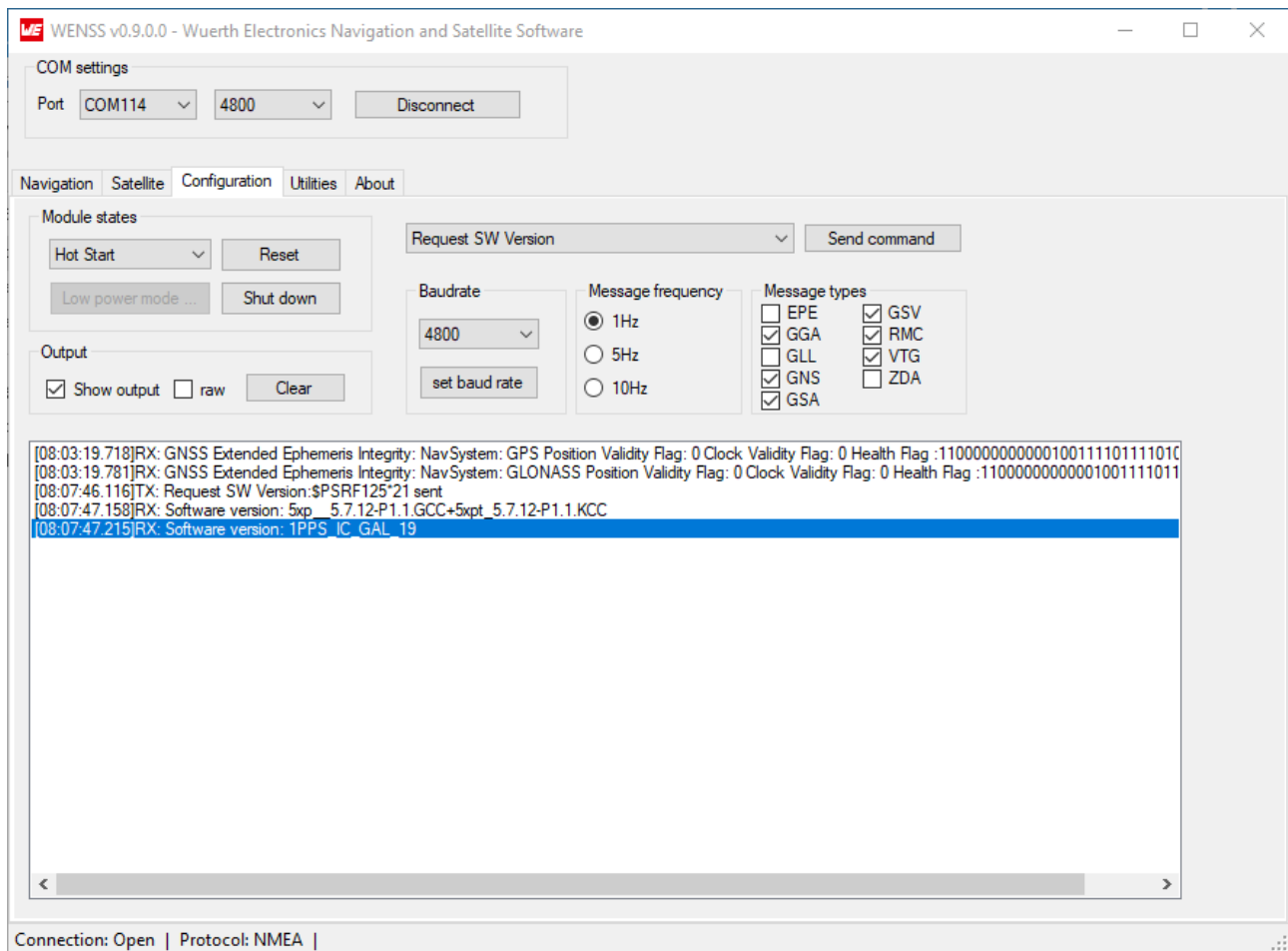

Figure 12: PC-Tool

4.1.1 Putting into operation - UART with Thyone-I proprietary RF module (only for 2614029237011)

The Thyone-I module on the evaluation board, together with the USB plug included in the evaluation kit, allows transmission of the messages from the GNSS module via RF link to the host PC. The same RF link can be used to send input commands from the host PC to the GNSS module.

The evaluation board can be used in standalone mode using AAA batteries.

The Thyone-I module is configured in transparent mode: it sends out the incoming messages without further configuration steps needed.



The configuration with Thyone-I module and plug is only supported with the GNSS module working with the default baud rate (4800 baud) and default communication protocol (NMEA).



In order for the RF link between Thyone-I module and plug to be stable, they shall be placed at a maximum distance around 20 meters from each other. Presence of obstacles can have impact on this distance.

For putting into operation, please execute the following steps and refer to Figure 13.

- Make sure that the jumpers on the EV board are placed on the default locations.
- Make sure that the ON/OFF GNSS switch is in 'OFF' position.
- Switch jumper JP2 to position 3,4 to set the UART communication between Erinome-II and Thyone-I (see Chapter 3. 2).
- - Option A: for battery operation of the evaluation board, jumper JP8 shall be kept in default position 1,2 (see Chapter 3. 2).



Do not use Micro USB connection during battery operation

- Option B and C: for power supply from PC or power bank, jumper JP8 shall be kept in default position 1,2.
- - Option A: insert two AAA batteries in the battery holder placed on the back side of the evaluation board.
- Option B: connect the evaluation board to the PC via USB-cable (included in the evaluation kit).
- Option C: connect the evaluation board to a power bank via USB-cable.

- Connect the Thyone-I USB plug to the host PC.
- Make sure that the FTDI driver package is installed on the PC. The latest version of the drivers can be downloaded from (www.ftdichip.com/Drivers/VCP.htm). Please use the setup executable package or follow the install instructions from FTDI.
- Make sure that the COM port is detected and installed on the PC. The COM port name of the evaluation board can be found using the device manager on Windows and the display message (dmesg) on Linux. For example, the evaluation board might appear similar to "COM12" on windows and "/dev/ttyUSB0" on Linux. Once the COM port is detected, USB initialisation is completed.
- WENSS PC-tool can be used to take the evaluation board into operation and communicate with the module. Once started:
 - select the correct COM port used by the USB plug
 - select baud rate 115200
 - click "connect"
- Switch the ON/OFF GNSS Button to 'ON' position to switch the module from hibernate to full power state.
- Flow of NMEA messages from the GNSS module should now be visible in the PC-tool (tab "Navigation"). Please refer to the PC-tool manual for detailed information. Two LEDs on the evaluation board (RF_BUSY and RF_ST) and one LED on the USB plug should blink, confirming that the RF communication is properly established and that data exchange is taking place.

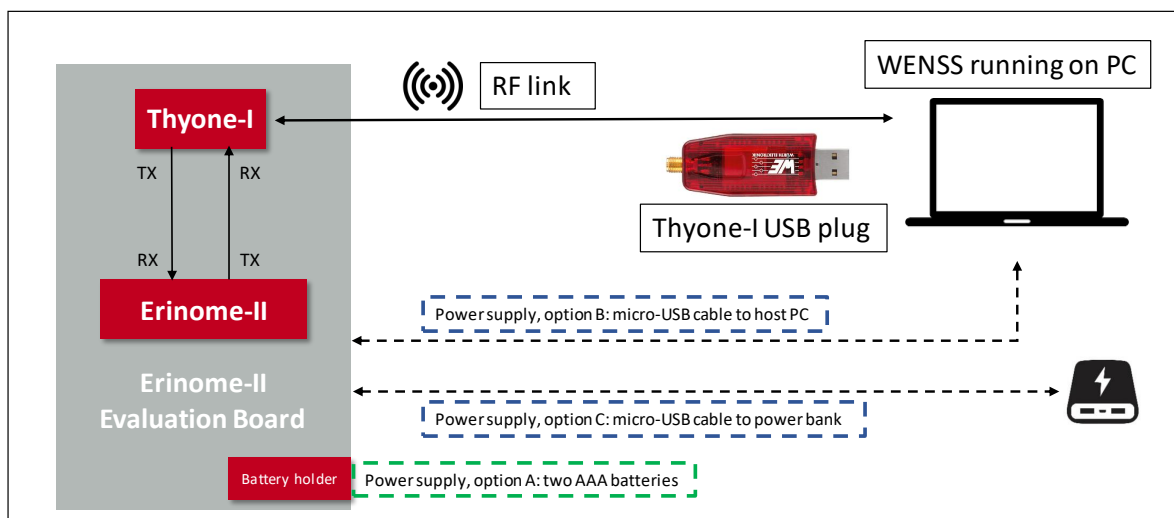

Figure 13: Putting into operation - Thyone-I + Erinome-II

4.2 Putting into operation - I²C

The I²C (Inter-IC) bus interface can be selected as the communication interface in the GNSS module through */CTS* and */RTS* pins. During power up, the module recognizes the I²C bus interface through the */CTS* and */RTS* pin connections as per table 4.

Interface	<i>/CTS</i>	<i>/RTS</i>
I ² C	Open	External pull-down

Table 4: I²C Interface Setting

By default the evaluation board is implemented with UART interface. To communicate with the module through I²C bus interface, modifications on the evaluation board are required by the user. Details follow in the next sections.

4.2.1 Hardware Setup - Erinome-II

I²C hardware setup for Erinome-II evaluation board is shown in the figure 14.

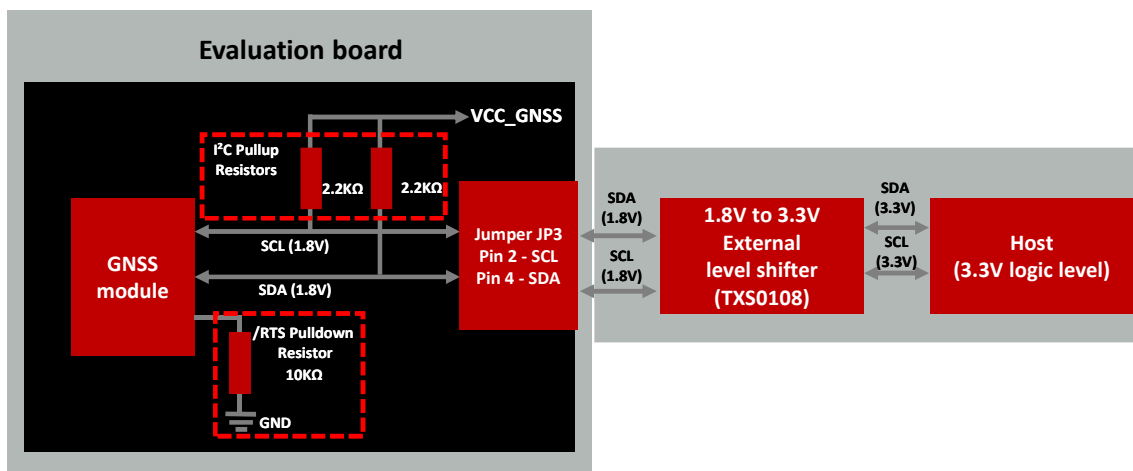

Figure 14: I²C Hardware setup - Erinome-II

The block diagram illustrates the pull-up resistors assembly for the SDA and SCL bus lines as well as the pull-down resistor on the */RTS* pin for booting up in I²C interface mode. It also shows that the I²C bus access on evaluation board jumper JP3-2 and JP3-4 can be used to connect the bus to a host.

The I²C bus outputs on jumper JP3 are 1.8V logic levels. Therefore, a suitable level shifter is needed for further logic level translation (i.e. when the host does not support 1.8V logic level). For a logic level translation to 3.3V, the level shifter TXS0108 by Texas Instruments is used in the tested hardware setup. Further information of the level shifter can be found at <https://www.ti.com/product/TXS0108E>.



Please note that the level shifter shall use an open drain circuit and support I²C communication.

4.2.2 Evaluation Board Modification - Erinome-II

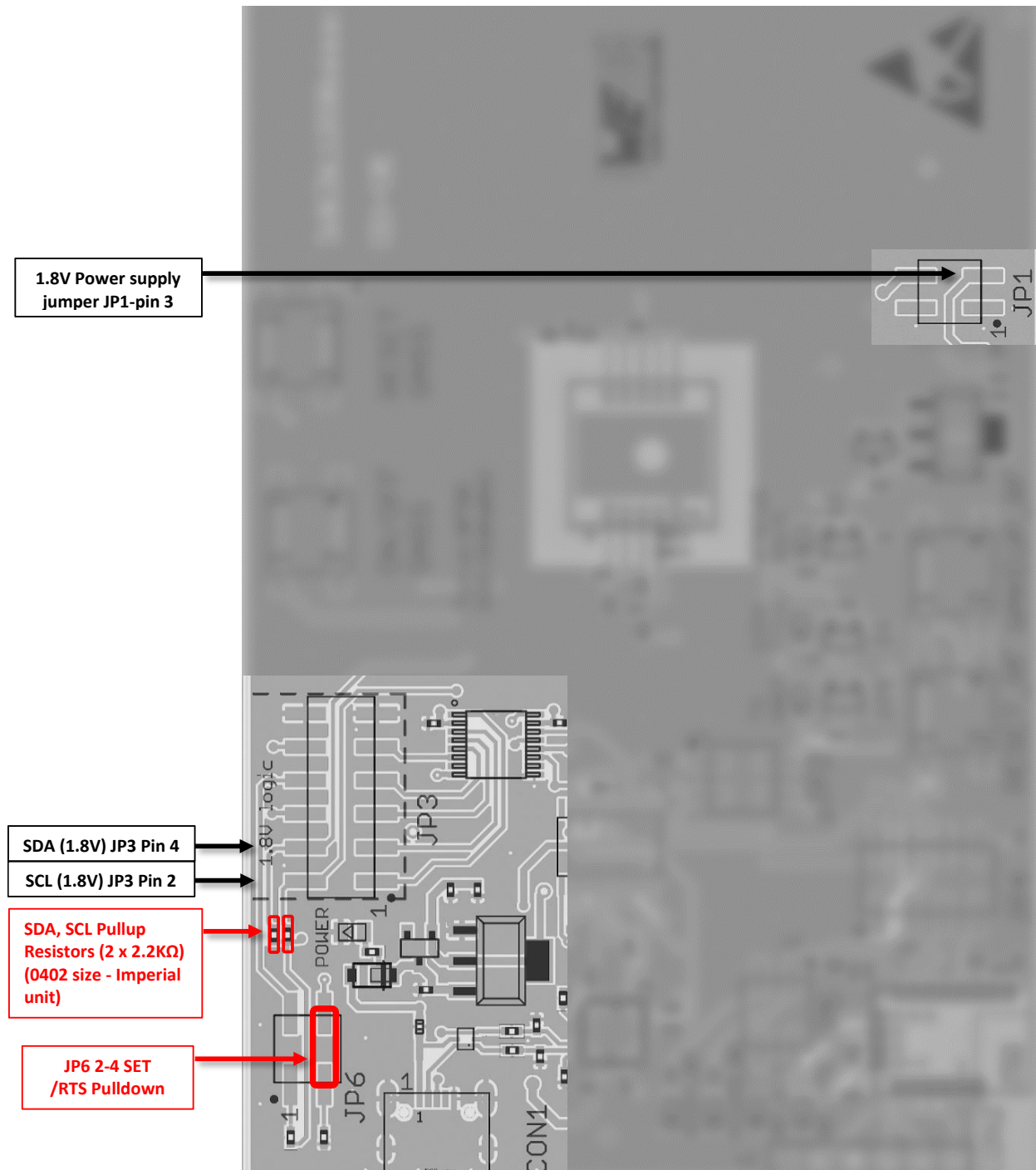

Figure 15: I²C evaluation board modification - Erinome-II

Figure 15 illustrates the necessary modification to be done on the evaluation board for I²C communication.

The following changes must be done:

- Solder 2.2k Ω pull-up resistors on the SDA and SCL bus
- Connecting 10k Ω pull-down resistor on /RTS line by setting the jumper on JP6: Pin 2-4.



Apart from the hardware modifications listed above, other jumpers shall be kept in default position, please refer to module specific evaluation board manual.

The I²C bus (1.8V logic level) can be accessed through the jumper JP3.

Jumper JP3 (1.8V logic level)	
I ² C SCL	Pin 2
I ² C SDA	Pin 4
Ground	Pin 12

Table 5: I²C Jumper JP3 Connection - Erinome-II

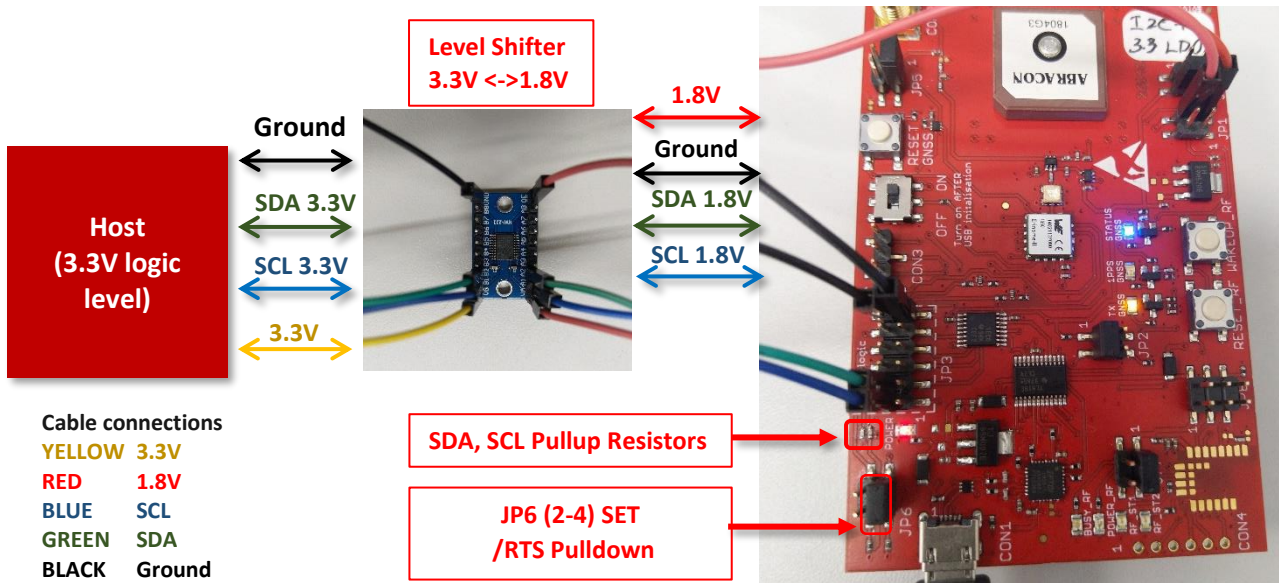

Figure 16: Erinome-II- GNSS evaluation board connection to 3.3V Host

For further information about I²C communication with the Erinome-II, including an application example with Aardvark and its matching PC software, please refer to our dedicated application note: *Application Note ANR018*.

4.3 Putting into operation - SPI

The SPI bus interface can be selected as the communication interface for the GNSS module through `/CTS` and `/RTS` pins. Table 6 gives the needed setting during power up for the `/CTS` and `/RTS` pins to activate the SPI communication.

Interface	/CTS	/RTS
SPI	Open	Open

Table 6: SPI Interface Setting

By default the evaluation board is implemented with UART interface. To communicate with the module through SPI bus interface, defined jumper settings have to be done by the user. Details follow in the next sections.

4.3.1 Hardware Setup - SPI

SPI hardware setup for Erinome-II evaluation board is shown in the figure 17.

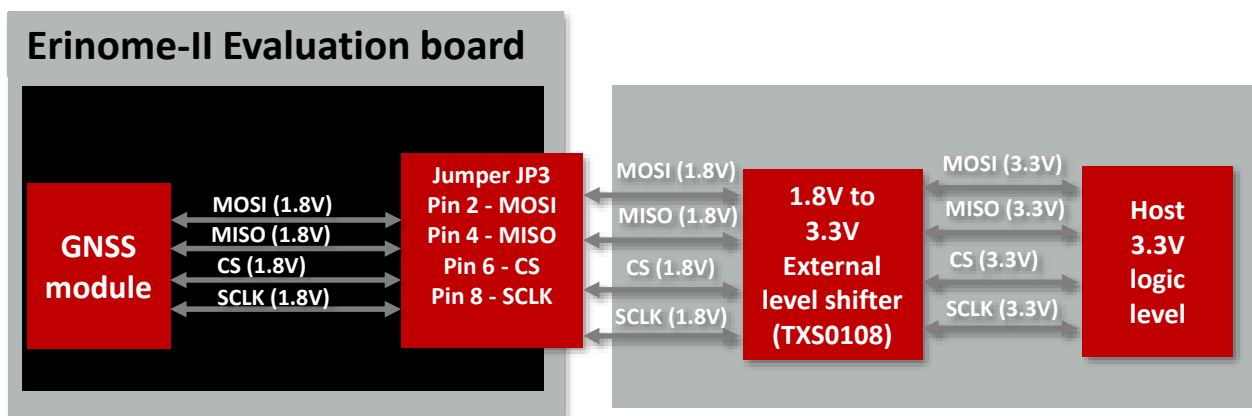

Figure 17: SPI Hardware setup

The block diagram illustrates the SPI bus access on evaluation board jumper JP3 and connection to a host with a logic of 3.3V.

The SPI bus outputs on jumper JP3 are 1.8V logic levels. Therefore, a suitable level shifter is needed for further logic level translation (i.e. when the host does not support 1.8V logic level). For a logic level translation to 3.3V, the level shifter TXS0108 by Texas Instruments is used in the tested hardware setup. Further information of the level shifter can be found at <https://www.ti.com/product/TXS0108E>.



Please note that the level shifter shall use a push-pull circuit and support SPI communication.

4.3.2 Evaluation Board Setup - SPI

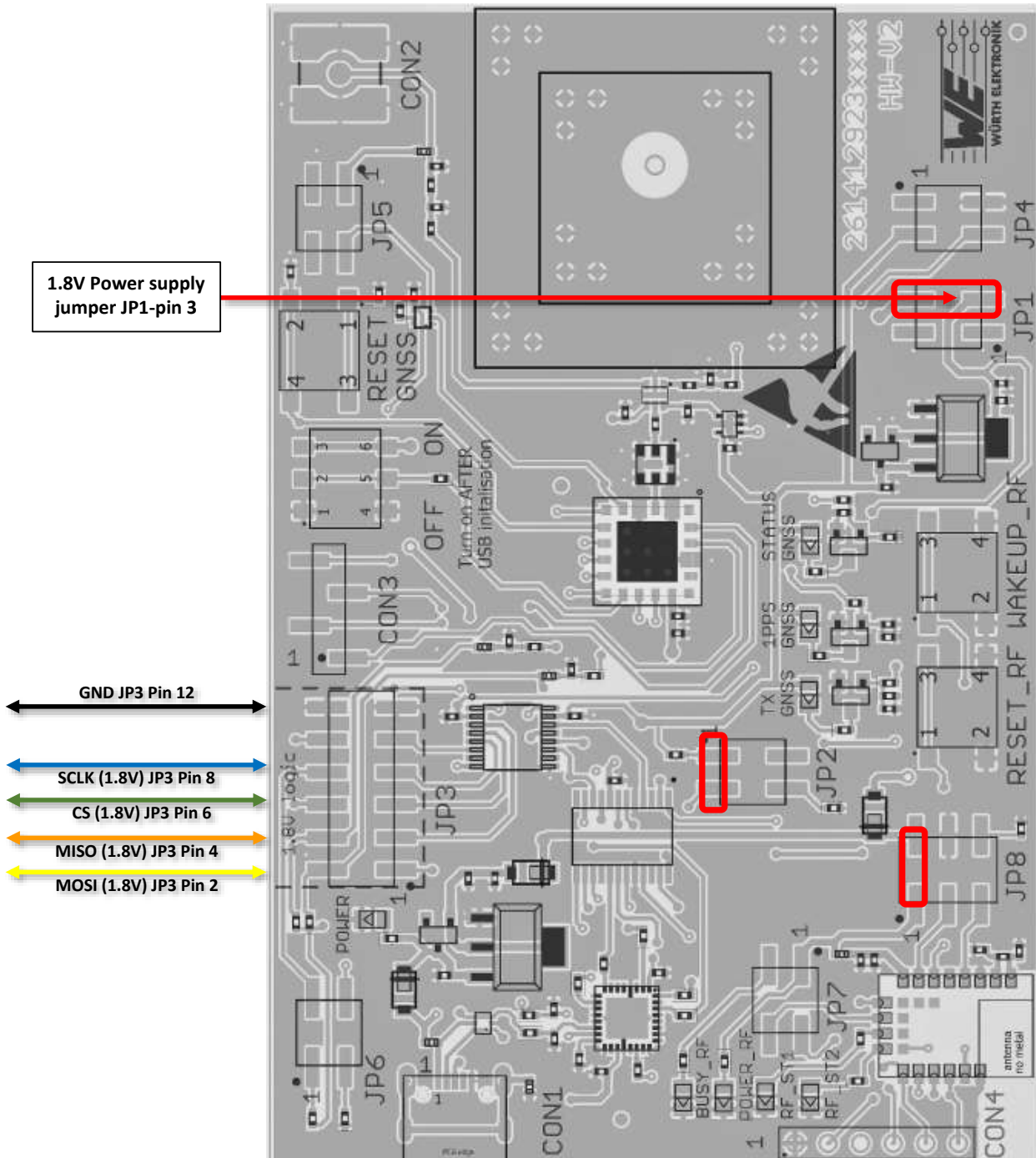

Figure 18: SPI bus access on evaluation board

Figure 18 illustrates the jumper settings and the necessary pins to access the SPI bus on the evaluation board.

The SPI bus (1.8V logic level) can be accessed through the jumper JP3.

Jumper JP3 (1.8V logic level)	
MOSI	Pin 2
MISO	Pin 4
CS	Pin 6
SCLK	Pin 8
Ground	Pin 12

Table 7: SPI Jumper JP3 Connection - Erinome-II



During module power up the JP3 pins shall be left open.

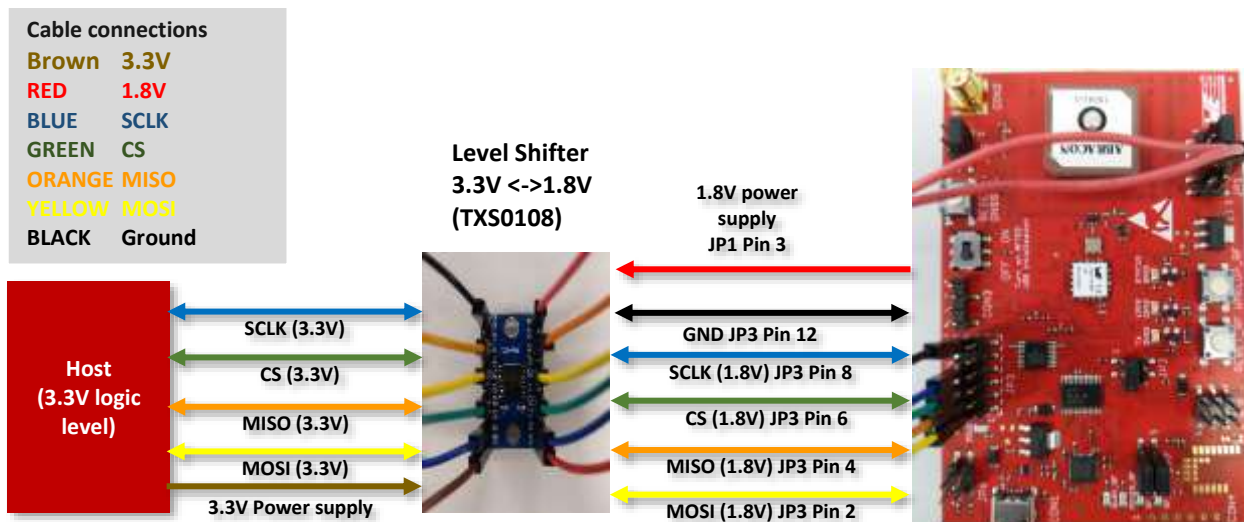

Figure 19: SPI communication setup - Erinome-II evaluation board to 3.3V Host

5 Regulatory compliance information

Pursuant to Article 1 (2.) of the EU directive 2014/53/EU, Article 1 (2.) the directive does not apply to equipment listed in Annex I (4.): custom-built evaluation kits destined for professionals to be used solely at research and development facilities for such purposes.

5.1 Exemption clause

Relevant regulation requirements are subject to change. Würth Elektronik eiSos does not guarantee the accuracy of the before mentioned information. Directives, technical standards, procedural descriptions and the like may be interpreted differently by the national authorities. Equally, the national laws and restrictions may vary with the country. In case of doubt or uncertainty, we recommend that you consult with the authorities or official certification organizations of the relevant countries. Würth Elektronik eiSos is exempt from any responsibilities or liabilities related to regulatory compliance.

Notwithstanding the above, Würth Elektronik eiSos makes no representations and warranties of any kind related to their accuracy, correctness, completeness and/or usability for customer applications. No responsibility is assumed for inaccuracies or incompleteness.

6 Important notes

The following conditions apply to all goods within the wireless connectivity product range of Würth Elektronik eiSos GmbH & Co. KG:

6.1 General customer responsibility

Some goods within the product range of Würth Elektronik eiSos GmbH & Co. KG contain statements regarding general suitability for certain application areas. These statements about suitability are based on our knowledge and experience of typical requirements concerning the areas, serve as general guidance and cannot be estimated as binding statements about the suitability for a customer application. The responsibility for the applicability and use in a particular customer design is always solely within the authority of the customer. Due to this fact, it is up to the customer to evaluate, where appropriate to investigate and to decide whether the device with the specific product characteristics described in the product specification is valid and suitable for the respective customer application or not. Accordingly, the customer is cautioned to verify that the documentation is current before placing orders.

6.2 Customer responsibility related to specific, in particular safety-relevant applications

It has to be clearly pointed out that the possibility of a malfunction of electronic components or failure before the end of the usual lifetime cannot be completely eliminated in the current state of the art, even if the products are operated within the range of the specifications. The same statement is valid for all software sourcecode and firmware parts contained in or used with or for products in the wireless connectivity and sensor product range of Würth Elektronik eiSos GmbH & Co. KG. In certain customer applications requiring a high level of safety and especially in customer applications in which the malfunction or failure of an electronic component could endanger human life or health, it must be ensured by most advanced technological aid of suitable design of the customer application that no injury or damage is caused to third parties in the event of malfunction or failure of an electronic component.

6.3 Best care and attention

Any product-specific data sheets, manuals, application notes, PCN's, warnings and cautions must be strictly observed in the most recent versions and matching to the products firmware revisions. This documents can be downloaded from the product specific sections on the wireless connectivity homepage.

6.4 Customer support for product specifications

Some products within the product range may contain substances, which are subject to restrictions in certain jurisdictions in order to serve specific technical requirements. Necessary information is available on request. In this case, the field sales engineer or the internal sales person in charge should be contacted who will be happy to support in this matter.

6.5 Product improvements

Due to constant product improvement, product specifications may change from time to time. As a standard reporting procedure of the Product Change Notification (PCN) according to the JEDEC-Standard, we inform about major changes. In case of further queries regarding the PCN, the field sales engineer, the internal sales person or the technical support team in charge should be contacted. The basic responsibility of the customer as per section 6.1 and 6.2 remains unaffected. All wireless connectivity module driver software "wireless connectivity SDK" and its source codes as well as all PC software tools are not subject to the Product Change Notification information process.

6.6 Product life cycle

Due to technical progress and economical evaluation we also reserve the right to discontinue production and delivery of products. As a standard reporting procedure of the Product Termination Notification (PTN) according to the JEDEC-Standard we will inform at an early stage about inevitable product discontinuance. According to this, we cannot ensure that all products within our product range will always be available. Therefore, it needs to be verified with the field sales engineer or the internal sales person in charge about the current product availability expectancy before or when the product for application design-in disposal is considered. The approach named above does not apply in the case of individual agreements deviating from the foregoing for customer-specific products.

6.7 Property rights

All the rights for contractual products produced by Würth Elektronik eiSos GmbH & Co. KG on the basis of ideas, development contracts as well as models or templates that are subject to copyright, patent or commercial protection supplied to the customer will remain with Würth Elektronik eiSos GmbH & Co. KG. Würth Elektronik eiSos GmbH & Co. KG does not warrant or represent that any license, either expressed or implied, is granted under any patent right, copyright, mask work right, or other intellectual property right relating to any combination, application, or process in which Würth Elektronik eiSos GmbH & Co. KG components or services are used.

6.8 General terms and conditions

Unless otherwise agreed in individual contracts, all orders are subject to the current version of the "General Terms and Conditions of Würth Elektronik eiSos Group", last version available at www.we-online.com.

7 Legal notice

7.1 Exclusion of liability

Würth Elektronik eiSos GmbH & Co. KG considers the information in this document to be correct at the time of publication. However, Würth Elektronik eiSos GmbH & Co. KG reserves the right to modify the information such as technical specifications or functions of its products or discontinue the production of these products or the support of one of these products without any written announcement or notification to customers. The customer must make sure that the information used corresponds to the latest published information. Würth Elektronik eiSos GmbH & Co. KG does not assume any liability for the use of its products. Würth Elektronik eiSos GmbH & Co. KG does not grant licenses for its patent rights or for any other of its intellectual property rights or third-party rights.

Notwithstanding anything above, Würth Elektronik eiSos GmbH & Co. KG makes no representations and/or warranties of any kind for the provided information related to their accuracy, correctness, completeness, usage of the products and/or usability for customer applications. Information published by Würth Elektronik eiSos GmbH & Co. KG regarding third-party products or services does not constitute a license to use such products or services or a warranty or endorsement thereof.

7.2 Suitability in customer applications

The customer bears the responsibility for compliance of systems or units, in which Würth Elektronik eiSos GmbH & Co. KG products are integrated, with applicable legal regulations. Customer acknowledges and agrees that it is solely responsible for compliance with all legal, regulatory and safety-related requirements concerning its products, and any use of Würth Elektronik eiSos GmbH & Co. KG components in its applications, notwithstanding any applications-related information or support that may be provided by Würth Elektronik eiSos GmbH & Co. KG. Customer represents and agrees that it has all the necessary expertise to create and implement safeguards which anticipate dangerous consequences of failures, monitor failures and their consequences lessen the likelihood of failures that might cause harm and take appropriate remedial actions. The customer will fully indemnify Würth Elektronik eiSos GmbH & Co. KG and its representatives against any damages arising out of the use of any Würth Elektronik eiSos GmbH & Co. KG components in safety-critical applications.

7.3 Trademarks

AMBER wireless is a registered trademark of Würth Elektronik eiSos GmbH & Co. KG. All other trademarks, registered trademarks, and product names are the exclusive property of the respective owners.

7.4 Usage restriction

Würth Elektronik eiSos GmbH & Co. KG products have been designed and developed for usage in general electronic equipment only. This product is not authorized for use in equipment where a higher safety standard and reliability standard is especially required or where

a failure of the product is reasonably expected to cause severe personal injury or death, unless the parties have executed an agreement specifically governing such use. Moreover, Würth Elektronik eiSos GmbH & Co. KG products are neither designed nor intended for use in areas such as military, aerospace, aviation, nuclear control, submarine, transportation (automotive control, train control, ship control), transportation signal, disaster prevention, medical, public information network etc. Würth Elektronik eiSos GmbH & Co. KG must be informed about the intent of such usage before the design-in stage. In addition, sufficient reliability evaluation checks for safety must be performed on every electronic component, which is used in electrical circuits that require high safety and reliability function or performance. By using Würth Elektronik eiSos GmbH & Co. KG products, the customer agrees to these terms and conditions.

8 License terms

This License Terms will take effect upon the purchase and usage of the Würth Elektronik eiSos GmbH & Co. KG wireless connectivity products. You hereby agree that this license terms is applicable to the product and the incorporated software, firmware and source codes (collectively, "Software") made available by Würth Elektronik eiSos in any form, including but not limited to binary, executable or source code form.

The software included in any Würth Elektronik eiSos wireless connectivity product is purchased to you on the condition that you accept the terms and conditions of this license terms. You agree to comply with all provisions under this license terms.

8.1 Limited license

Würth Elektronik eiSos hereby grants you a limited, non-exclusive, non-transferable and royalty-free license to use the software and under the conditions that will be set forth in this license terms. You are free to use the provided Software only in connection with one of the products from Würth Elektronik eiSos to the extent described in this license terms. You are entitled to change or alter the source code for the sole purpose of creating an application embedding the Würth Elektronik eiSos wireless connectivity product. The transfer of the source code to third parties is allowed to the sole extent that the source code is used by such third parties in connection with our product or another hardware provided by Würth Elektronik eiSos under strict adherence of this license terms. Würth Elektronik eiSos will not assume any liability for the usage of the incorporated software and the source code. You are not entitled to transfer the source code in any form to third parties without prior written consent of Würth Elektronik eiSos.

You are not allowed to reproduce, translate, reverse engineer, decompile, disassemble or create derivative works of the incorporated Software and the source code in whole or in part. No more extensive rights to use and exploit the products are granted to you.

8.2 Usage and obligations

The responsibility for the applicability and use of the Würth Elektronik eiSos wireless connectivity product with the incorporated Firmware in a particular customer design is always solely within the authority of the customer. Due to this fact, it is up to you to evaluate and investigate, where appropriate, and to decide whether the device with the specific product characteristics described in the product specification is valid and suitable for your respective application or not.

You are responsible for using the Würth Elektronik eiSos wireless connectivity product with the incorporated Firmware in compliance with all applicable product liability and product safety laws. You acknowledge to minimize the risk of loss and harm to individuals and bear the risk for failure leading to personal injury or death due to your usage of the product.

Würth Elektronik eiSos' products with the incorporated Firmware are not authorized for use in safety-critical applications, or where a failure of the product is reasonably expected to cause severe personal injury or death. Moreover, Würth Elektronik eiSos' products with the incorporated Firmware are neither designed nor intended for use in areas such as military, aerospace, aviation, nuclear control, submarine, transportation (automotive control, train control, ship control), transportation signal, disaster prevention, medical, public information network etc. You shall inform Würth Elektronik eiSos about the intent of such usage before

design-in stage. In certain customer applications requiring a very high level of safety and in which the malfunction or failure of an electronic component could endanger human life or health, you must ensure to have all necessary expertise in the safety and regulatory ramifications of your applications. You acknowledge and agree that you are solely responsible for all legal, regulatory and safety-related requirements concerning your products and any use of Würth Elektronik eiSos' products with the incorporated Firmware in such safety-critical applications, notwithstanding any applications-related information or support that may be provided by Würth Elektronik eiSos. YOU SHALL INDEMNIFY WÜRTH ELEKTRONIK EISOS AGAINST ANY DAMAGES ARISING OUT OF THE USE OF WÜRTH ELEKTRONIK EISOS' PRODUCTS WITH THE INCORPORATED FIRMWARE IN SUCH SAFETY-CRITICAL APPLICATIONS.

8.3 Ownership

The incorporated Firmware created by Würth Elektronik eiSos is and will remain the exclusive property of Würth Elektronik eiSos.

8.4 Firmware update(s)

You have the opportunity to request the current and actual Firmware for a bought wireless connectivity Product within the time of warranty. However, Würth Elektronik eiSos has no obligation to update a modules firmware in their production facilities, but can offer this as a service on request. The upload of firmware updates falls within your responsibility, e.g. via ACC or another software for firmware updates. Firmware updates will not be communicated automatically. It is within your responsibility to check the current version of a firmware in the latest version of the product manual on our website. The revision table in the product manual provides all necessary information about firmware updates. There is no right to be provided with binary files, so called "Firmware images", those could be flashed through JTAG, SWD, Spi-Bi-Wire, SPI or similar interfaces.

8.5 Disclaimer of warranty

THE FIRMWARE IS PROVIDED "AS IS". YOU ACKNOWLEDGE THAT WÜRTH ELEKTRONIK EISOS MAKES NO REPRESENTATIONS AND WARRANTIES OF ANY KIND RELATED TO, BUT NOT LIMITED TO THE NON-INFRINGEMENT OF THIRD PARTIES' INTELLECTUAL PROPERTY RIGHTS OR THE MERCHANTABILITY OR FITNESS FOR YOUR INTENDED PURPOSE OR USAGE. WÜRTH ELEKTRONIK EISOS DOES NOT WARRANT OR REPRESENT THAT ANY LICENSE, EITHER EXPRESS OR IMPLIED, IS GRANTED UNDER ANY PATENT RIGHT, COPYRIGHT, MASK WORK RIGHT, OR OTHER INTELLECTUAL PROPERTY RIGHT RELATING TO ANY COMBINATION, MACHINE, OR PROCESS IN WHICH THE WÜRTH ELEKTRONIK EISOS' PRODUCT WITH THE INCORPORATED FIRMWARE IS USED. INFORMATION PUBLISHED BY WÜRTH ELEKTRONIK EISOS REGARDING THIRD-PARTY PRODUCTS OR SERVICES DOES NOT CONSTITUTE A LICENSE FROM WÜRTH ELEKTRONIK EISOS TO USE SUCH PRODUCTS OR SERVICES OR A WARRANTY OR ENDORSEMENT THEREOF.

8.6 Limitation of liability

Any liability not expressly provided by Würth Elektronik eiSos shall be disclaimed. You agree to hold us harmless from any third-party claims related to your usage of the Würth Elektronik eiSos' products with the incorporated Firmware, software and source code. Würth Elektronik eiSos disclaims any liability for any alteration, development created by you or your customers as well as for any combination with other products.

8.7 Applicable law and jurisdiction

Applicable law to this license terms shall be the laws of the Federal Republic of Germany. Any dispute, claim or controversy arising out of or relating to this license terms shall be resolved and finally settled by the court competent for the location of Würth Elektronik eiSos' registered office.

8.8 Severability clause

If a provision of this license terms is or becomes invalid, unenforceable or null and void, this shall not affect the remaining provisions of the terms. The parties shall replace any such provisions with new valid provisions that most closely approximate the purpose of the terms.

8.9 Miscellaneous

Würth Elektronik eiSos reserves the right at any time to change this terms at its own discretion. It is your responsibility to check at Würth Elektronik eiSos homepage for any updates. Your continued usage of the products will be deemed as the acceptance of the change. We recommend you to be updated about the status of new firmware and software, which is available on our website or in our data sheet and manual, and to implement new software in your device where appropriate. By ordering a wireless connectivity product, you accept this license terms in all terms.

List of Figures

1	2614029237001 - product image	6
2	2614029237011 - detail of the Thyone-I RF interface	7
3	Block diagram	9
4	Jumpers, defaults	10
5	Connectors	13
6	Switches and Buttons	16
7	Schematic sheet-1	21
8	Schematic sheet-2	22
9	Schematic sheet-3	23
10	Assembly diagram	24
11	Top,bottom & internal layers	25
12	PC-Tool	27
13	Putting into operation - Thyone-I + Erinome-II	29
14	I ² C Hardware setup - Erinome-II	30
15	I ² C evaluation board modification - Erinome-II	31
16	Erinome-II- GNSS evaluation board connection to 3.3V Host	32
17	SPI Hardware setup	33
18	SPI bus access on evaluation board	34
19	SPI communication setup - Erinome-II evaluation board to 3.3V Host	35

List of Tables

1	Compatibility	6
2	Content Erinome-II module EV-Kit	7
3	Content Erinome-II module EV-Kit with Thyone-I RF interface	7
4	I ² C Interface Setting	30
5	I ² C Jumper JP3 Connection - Erinome-II	32
6	SPI Interface Setting	33
7	SPI Jumper JP3 Connection - Erinome-II	35



more than you expect



**Internet
of Things**



**Monitoring
& Control**



**Automated Meter
Reading**

Contact:

Würth Elektronik eiSos GmbH & Co. KG
Division Wireless Connectivity & Sensors

Max-Eyth-Straße 1
74638 Waldenburg
Germany

Tel.: +49 651 99355-0

Fax.: +49 651 99355-69

www.we-online.com/wireless-connectivity

