

# ULTRA-SMALL, LOW-INPUT-VOLTAGE, LOW $r_{ON}$ LOAD SWITCH

Check for Samples: [TPS22924C](#)

## FEATURES

- **Integrated Single Load Switch**
- **Input Voltage: 0.75 V to 3.6 V**
- **Ultra-Low ON Resistance**
  - $r_{ON} = 18.3 \text{ m}\Omega$  at  $V_{IN} = 3.6 \text{ V}$
  - $r_{ON} = 18.5 \text{ m}\Omega$  at  $V_{IN} = 2.5 \text{ V}$
  - $r_{ON} = 19.6 \text{ m}\Omega$  at  $V_{IN} = 1.8 \text{ V}$
  - $r_{ON} = 19.4 \text{ m}\Omega$  at  $V_{IN} = 1.2 \text{ V}$
  - $r_{ON} = 20.3 \text{ m}\Omega$  at  $V_{IN} = 1.0 \text{ V}$
  - $r_{ON} = 22.7 \text{ m}\Omega$  at  $V_{IN} = 0.75 \text{ V}$
- **Ultra Small CSP-6 package**  
0.9 mm x 1.4 mm, 0.5-mm Pitch
- **2-A Maximum Continuous Switch Current**
- **Low Shutdown Current**
- **Low Threshold Control Input**
- **Controlled Slew Rate to Avoid Inrush Currents**
- **Quick Output Discharge Transistor**
- **ESD Performance Tested Per JESD 22**
  - **5000-V Human-Body Model**  
(A114-B, Class II)
  - **1000-V Charged-Device Model (C101)**

## APPLICATIONS

- **Battery Powered Equipment**
- **Portable Industrial Equipment**
- **Portable Medical Equipment**
- **Portable Media Players**
- **Point Of Sales Terminal**
- **GPS Devices**
- **Digital Cameras**
- **Netbooks / Notebooks**
- **Smartphones**

## DESCRIPTION

The TPS22924C is a small, ultra-low  $r_{ON}$  load switch with controlled turn on. The devices contain N-channel MOSFETs that can operate over an input voltage range of 0.75 V to 3.6 V. An integrated charge pump biases the NMOS switch to achieve a minimum switch ON resistance. The switch is controlled by an on/off input (ON), which is capable of interfacing directly with low-voltage control signals.

A 1250- $\Omega$  on-chip load resistor is added for output quick discharge when switch is turned off. The rise time of the device is internally controlled to avoid inrush current. The TPS22924C features a rise time of 800  $\mu\text{s}$  at 3.6 V.

The TPS22924C is available in an ultra-small space-saving 6-pin CSP package and is characterized for operation over the free-air temperature range of  $-40^{\circ}\text{C}$  to  $85^{\circ}\text{C}$ .

**Figure 1. TYPICAL APPLICATION**

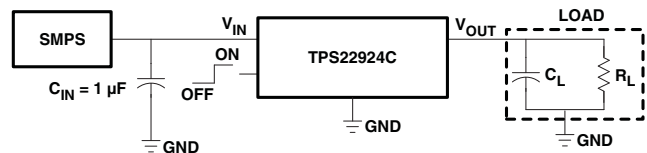

NOTE: SMPS = Switched-mode power supply

**Table 1. FEATURE LIST**

	$r_{ON}$ (TYP) AT 3.6 V	SLEW RATE (TYP) AT 3.6 V	QUICK OUTPUT DISCHARGE <sup>(1)</sup>	MAXIMUM OUTPUT CURRENT	ENABLE
TPS22924C	18.3 m $\Omega$	800 $\mu\text{s}$	Yes	2 A	Active high

(1) This feature discharges the output of the switch to ground through a 1250- $\Omega$  resistor, preventing the output from floating. See the *Output Pulldown* section in Application Information.



Please be aware that an important notice concerning availability, standard warranty, and use in critical applications of Texas Instruments semiconductor products and disclaimers thereto appears at the end of this data sheet.



These devices have limited built-in ESD protection. The leads should be shorted together or the device placed in conductive foam during storage or handling to prevent electrostatic damage to the MOS gates.

**ORDERING INFORMATION<sup>(1)</sup>**

T <sub>A</sub>	PACKAGE <sup>(2)</sup>		ORDERABLE PART NUMBER	TOP-SIDE MARKING <sup>(3)</sup>
-40°C to 85°C	DSBGA – YZP (0.5-mm pitch)	Tape and reel	TPS22924CZPR	_ _ _ 5L _

- (1) For the most current package and ordering information, see the Package Option Addendum at the end of this document, or see the TI web site at [www.ti.com](http://www.ti.com).
- (2) Package drawings, thermal data, and symbolization are available at [www.ti.com/packaging](http://www.ti.com/packaging).
- (3) The actual top-side marking has three preceding characters to denote year, month, and sequence code, and one following character to designate the wafer fab/assembly site. Pin 1 identifier indicates solder-bump composition (1 = SnPb, • = Pb-free).

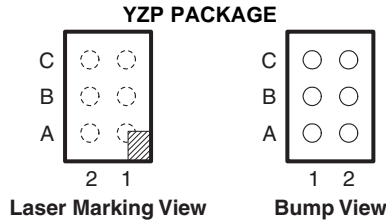

**TERMINALS ASSIGNMENTS (YZP PACKAGE)**

C	GND	ON
B	VOUT	VIN
A	VOUT	VIN
	1	2

**TERMINAL FUNCTIONS**

NO.	NAME	DESCRIPTION
C1	GND	Ground
C2	ON	Switch control input, active high. Do not leave floating
A1, B1	VOUT	Switch output
A2, B2	VIN	Switch input, bypass this input with a ceramic capacitor to ground

**BLOCK DIAGRAM**

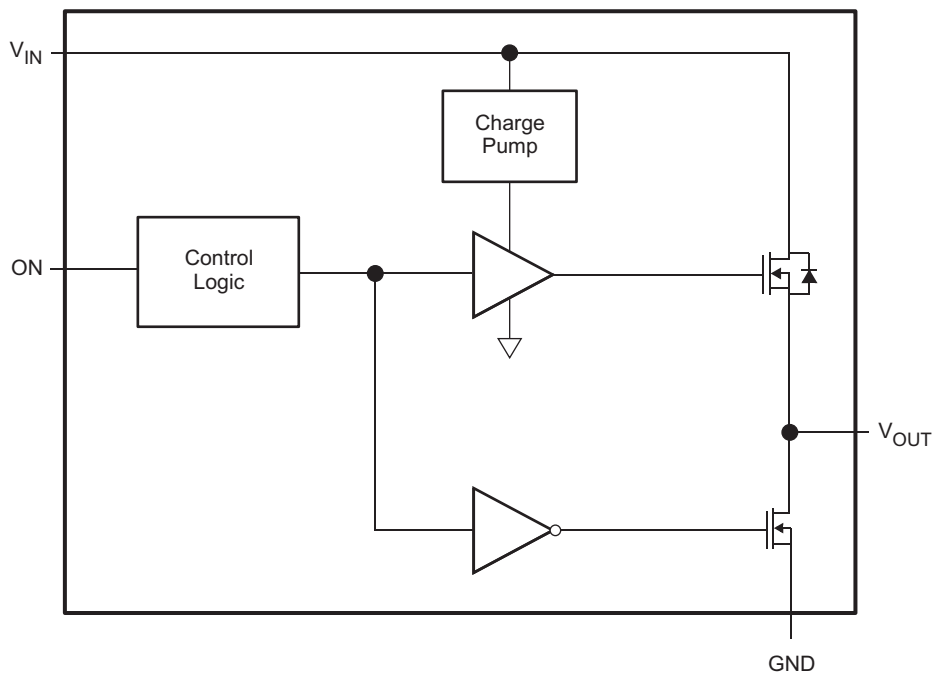

**FUNCTION TABLE**

ON (Control Signal)	VIN to VOUT	VOUT to GND <sup>(1)</sup>
L	OFF	ON
H	ON	OFF

(1) See application section *Output Pulldown*.

**ABSOLUTE MAXIMUM RATINGS<sup>(1)</sup>**

		MIN	MAX	UNIT
V <sub>IN</sub>	Input voltage range	-0.3	4	V
V <sub>OUT</sub>	Output voltage range		V <sub>IN</sub> + 0.3	V
V <sub>ON</sub>	Input voltage range	-0.3	4	V
I <sub>MAX</sub>	Maximum continuous switch current, T <sub>A</sub> = -40°C to 85°C		2	A
I <sub>PLS</sub>	Maximum pulsed switch current, 100-μs pulse, 2% duty cycle, T <sub>A</sub> = -40°C to 85°C		4	A
T <sub>A</sub>	Operating free-air temperature range	-40	85	°C
T <sub>stg</sub>	Storage temperature range	-65	150	°C
ESD	Electrostatic discharge protection	Human-Body Model (HBM)		V
		Charged-Device Model (CDM)		
			5000	
			1000	

- (1) Stresses beyond those listed under absolute maximum ratings may cause permanent damage to the device. These are stress ratings only, and functional operation of the device at these or any other conditions beyond those indicated under *Recommended Operating Conditions* is not implied. Exposure to absolute-maximum-rated conditions for extended periods may affect device reliability.

**DISSIPATION RATINGS**

BOARD	PACKAGE	R <sub>θJC</sub>	R <sub>θJA</sub>	DERATING FACTOR ABOVE T <sub>A</sub> = 25°C	T <sub>A</sub> < 25°C	T <sub>A</sub> = 70°C	T <sub>A</sub> = 85°C
High-K <sup>(1)</sup>	YZP	17.6°C/W	123.36°C/W	- 8.1063 mW/°C	810.63 mW	445.84 mW	324.25 mW

- (1) The JEDEC high-K (2s2p) board used to derive this data was a 3- × 3-inch, multilayer board with 1-ounce internal power and ground planes and 2-ounce copper traces on top and bottom of the board.

**RECOMMENDED OPERATING CONDITIONS**

		MIN	MAX	UNIT
V <sub>IN</sub>	Input voltage	0.75	3.6	V
V <sub>OUT</sub>	Output voltage		V <sub>IN</sub>	V
V <sub>IH</sub>	High-level input voltage, ON	V <sub>IN</sub> = 2.5 V to 3.6 V		V
		V <sub>IN</sub> = 0.75 V to 2.5 V		
V <sub>IL</sub>	Low-level input voltage, ON	V <sub>IN</sub> = 2.5 V to 3.6 V		V
		V <sub>IN</sub> = 0.75 V to 2.49 V		
C <sub>IN</sub>	Input capacitance	1 <sup>(1)</sup>		μF

- (1) See the *Input Capacitor* section in Application Information.

## ELECTRICAL CHARACTERISTICS

 $V_{IN} = 0.75\text{ V to }3.6\text{ V}$  (unless otherwise noted)

PARAMETER	TEST CONDITIONS	$T_A$	MIN	TYP <sup>(1)</sup>	MAX	UNIT	
$I_{IN}$ Quiescent current	$I_{OUT} = 0, V_{IN} = V_{ON}$	Full		$V_{IN} = 3.6\text{ V}$	75	160	$\mu\text{A}$
				$V_{IN} = 2.5\text{ V}$	42	70	
				$V_{IN} = 1.8\text{ V}$	50	350	
				$V_{IN} = 1.2\text{ V}$	95	200	
				$V_{IN} = 1.0\text{ V}$	65	110	
				$V_{IN} = 0.75\text{ V}$	35	70	
$I_{IN(LEAK)}$ OFF-state supply current	$V_{ON} = \text{GND}, \text{OUT} = 0\text{V}$	Full			3.5	$\mu\text{A}$	
$r_{ON}$ ON-state resistance	$I_{OUT} = -200\text{ mA}$	25°C	Full	$V_{IN} = 3.6\text{ V}$	18.3	19.7	$\text{m}\Omega$
				$V_{IN} = 2.5\text{ V}$	18.5	19.5	
		25°C	Full	$V_{IN} = 1.8\text{ V}$	19.6	21.8	
				$V_{IN} = 1.2\text{ V}$	19.4	21.8	
		25°C	Full	$V_{IN} = 1.0\text{ V}$	20.3	21.2	
				$V_{IN} = 0.75\text{ V}$	22.7	25.3	
		25°C	Full			26.0	
						25.8	
25°C	Full			27.4			
				28.0			
$r_{PD}$ Output pulldown resistance <sup>(2)</sup>	$V_{IN} = 3.3\text{ V}, V_{ON} = 0, I_{OUT} = 3\text{ mA}$	25°C		1250	1500	$\Omega$	
$I_{ON}$ ON-state input leakage current	$V_{ON} = 0.75\text{ V to }3.6\text{ V or GND}$	Full			0.1	$\mu\text{A}$	

(1) Typical values are at  $V_{IN} = 3.3\text{ V}$  and  $T_A = 25^\circ\text{C}$ .

(2) See [Output Pulldown](#) in *Application Information*.

## SWITCHING CHARACTERISTICS

 $V_{IN} = 3.6\text{ V}, T_A = 25^\circ\text{C}$  (unless otherwise noted)

PARAMETER	TEST CONDITIONS	MIN	TYP	MAX	UNIT
$t_{ON}$ Turn-ON time	$R_L = 10\ \Omega, C_L = 0.1\ \mu\text{F}, V_{IN} = 3.6\text{ V}$		800		$\mu\text{s}$
$t_{OFF}$ Turn-OFF time	$R_L = 10\ \Omega, C_L = 0.1\ \mu\text{F}, V_{IN} = 3.6\text{ V}$		3		$\mu\text{s}$
$t_r$ $V_{OUT}$ rise time	$R_L = 10\ \Omega, C_L = 0.1\ \mu\text{F}, V_{IN} = 3.6\text{ V}$		800		$\mu\text{s}$
$t_f$ $V_{OUT}$ fall time	$R_L = 10\ \Omega, C_L = 0.1\ \mu\text{F}, V_{IN} = 3.6\text{ V}$		2.5		$\mu\text{s}$

## SWITCHING CHARACTERISTICS

 $V_{IN} = 0.9\text{ V}, T_A = 25^\circ\text{C}$  (unless otherwise noted)

PARAMETER	TEST CONDITIONS	MIN	TYP	MAX	UNIT
$t_{ON}$ Turn-ON time	$R_L = 10\ \Omega, C_L = 0.1\ \mu\text{F}, V_{IN} = 0.9\text{ V}$		865		$\mu\text{s}$
$t_{OFF}$ Turn-OFF time	$R_L = 10\ \Omega, C_L = 0.1\ \mu\text{F}, V_{IN} = 0.9\text{ V}$		20		$\mu\text{s}$
$t_r$ $V_{OUT}$ rise time	$R_L = 10\ \Omega, C_L = 0.1\ \mu\text{F}, V_{IN} = 0.9\text{ V}$		500		$\mu\text{s}$
$t_f$ $V_{OUT}$ fall time	$R_L = 10\ \Omega, C_L = 0.1\ \mu\text{F}, V_{IN} = 0.9\text{ V}$		5		$\mu\text{s}$

**PARAMETER MEASUREMENT INFORMATION**

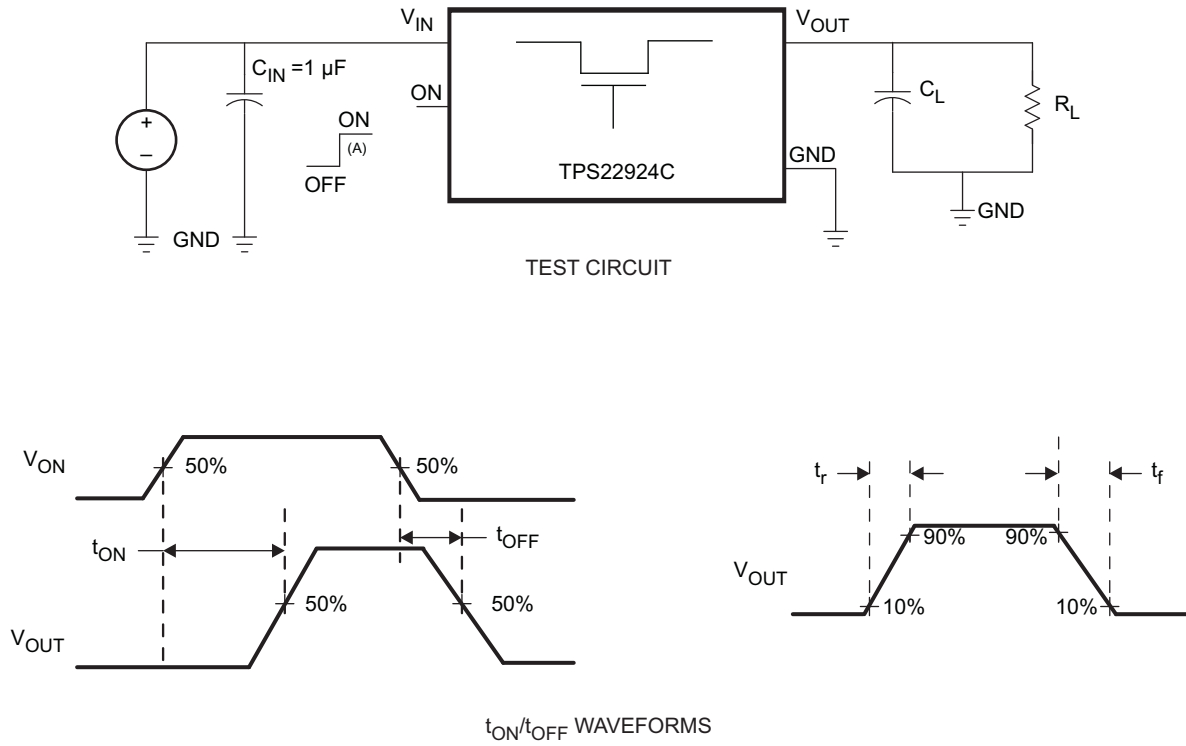

A.  $t_{rise}$  and  $t_{fall}$  of the control signal is 100 ns.

**Figure 2. Test Circuit and  $t_{ON}/t_{OFF}$  Waveforms**

TYPICAL CHARACTERISTICS

ON-STATE RESISTANCE  
vs  
INPUT VOLTAGE

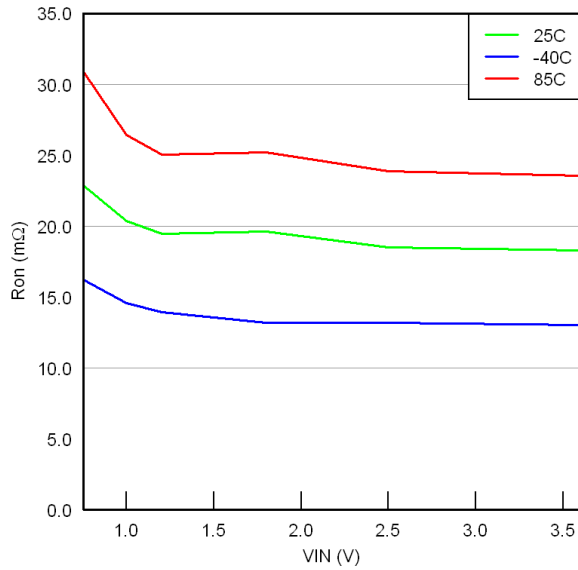

ON-STATE RESISTANCE  
vs  
TEMPERATURE

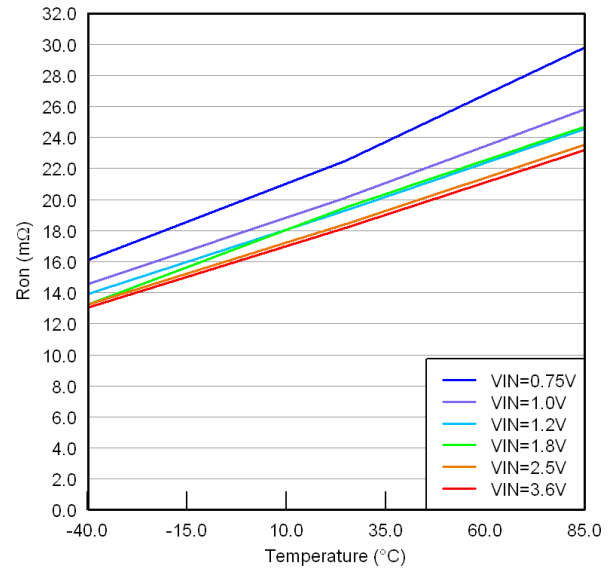

INPUT CURRENT, QUIESCENT  
vs  
INPUT VOLTAGE

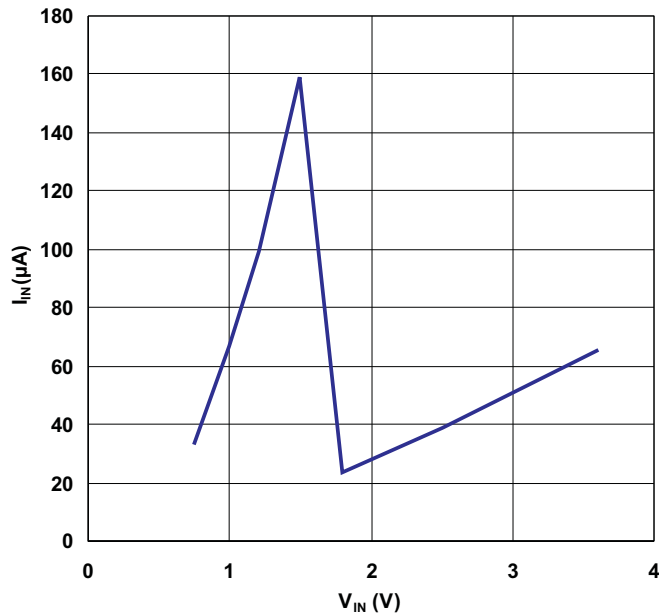

INPUT CURRENT, QUIESCENT  
vs  
TEMPERATURE

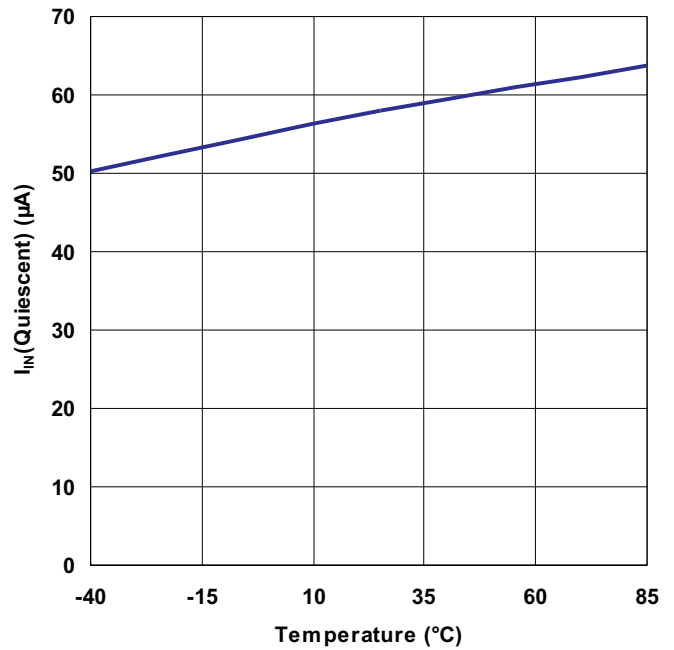

**TYPICAL CHARACTERISTICS (continued)**

**INPUT CURRENT, LEAK  
vs  
INPUT VOLTAGE**

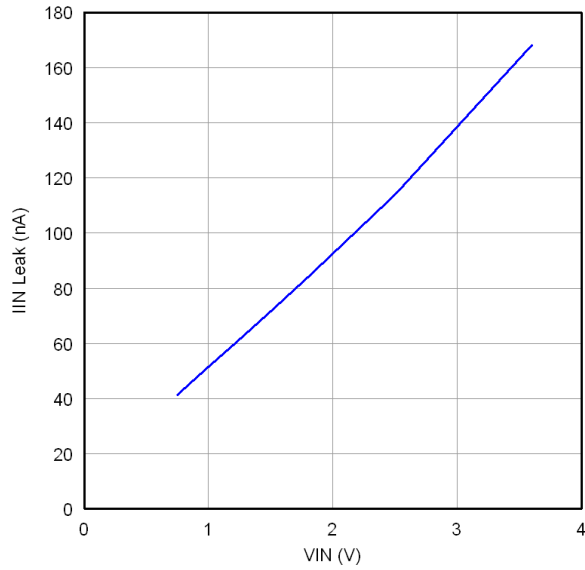

**INPUT CURRENT, LEAK  
vs  
TEMPERATURE  
VIN = 3.6V**

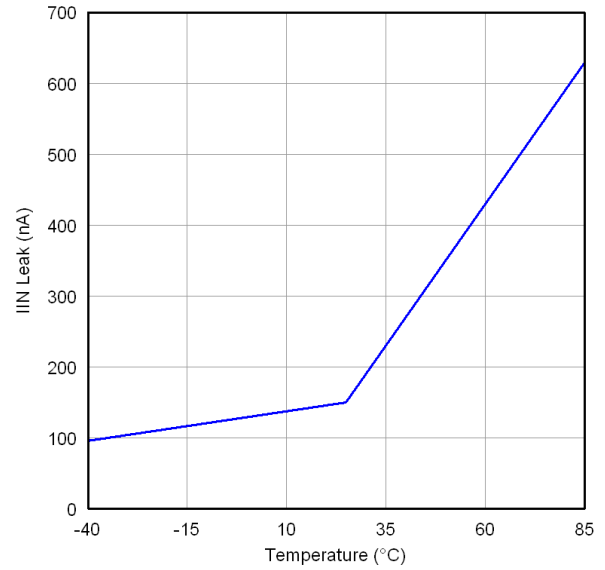

**ON INPUT THRESHOLD**

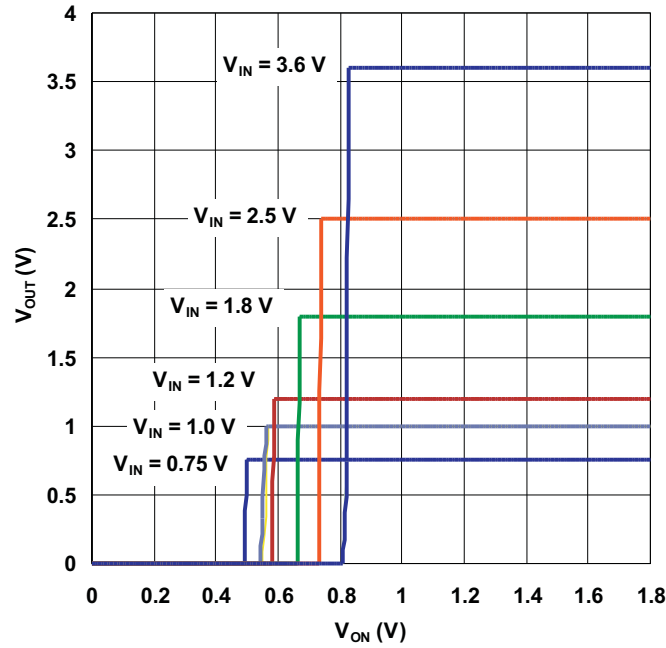



TYPICAL CHARACTERISTICS (continued)

TURN-ON TIME  
vs  
TEMPERATURE

$V_{IN} = 3.6\text{ V}$ ,  $C_L = 0.1\ \mu\text{F}$ ,  $R_L = 10\ \Omega$

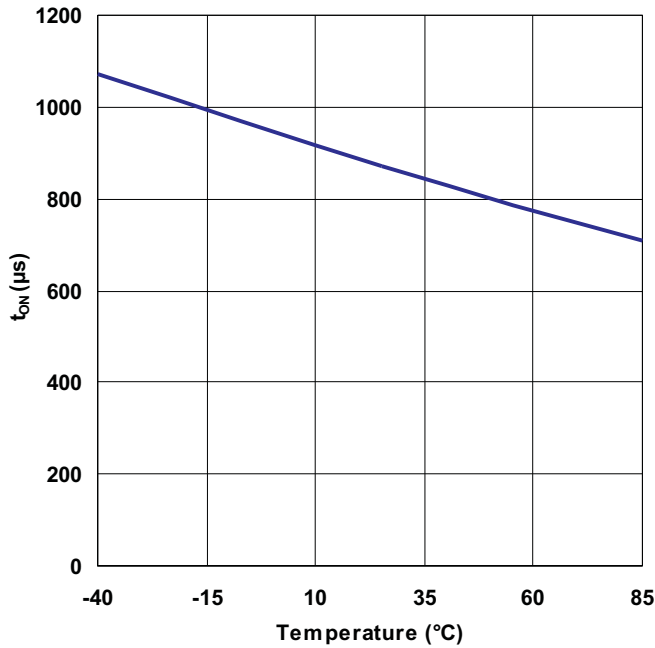

TURN-OFF TIME  
vs  
TEMPERATURE

$V_{IN} = 3.6\text{ V}$ ,  $C_L = 0.1\ \mu\text{F}$ ,  $R_L = 10\ \Omega$

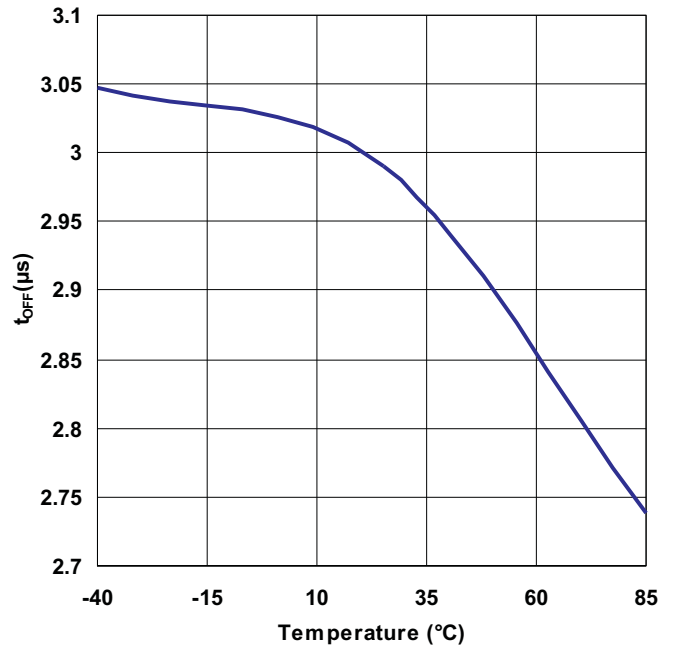

RISE TIME  
vs  
TEMPERATURE

$V_{IN} = 3.6\text{ V}$ ,  $C_L = 0.1\ \mu\text{F}$ ,  $R_L = 10\ \Omega$

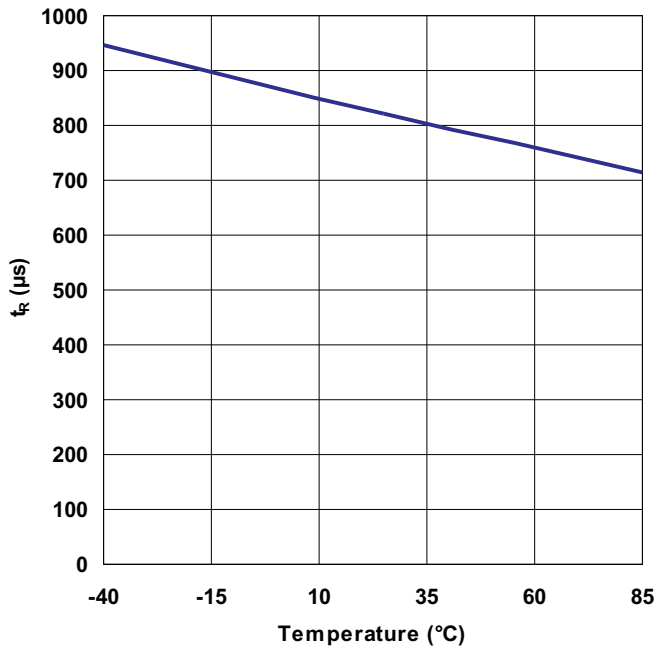

FALL TIME  
vs  
TEMPERATURE

$V_{IN} = 3.6\text{ V}$ ,  $C_L = 0.1\ \mu\text{F}$ ,  $R_L = 10\ \Omega$

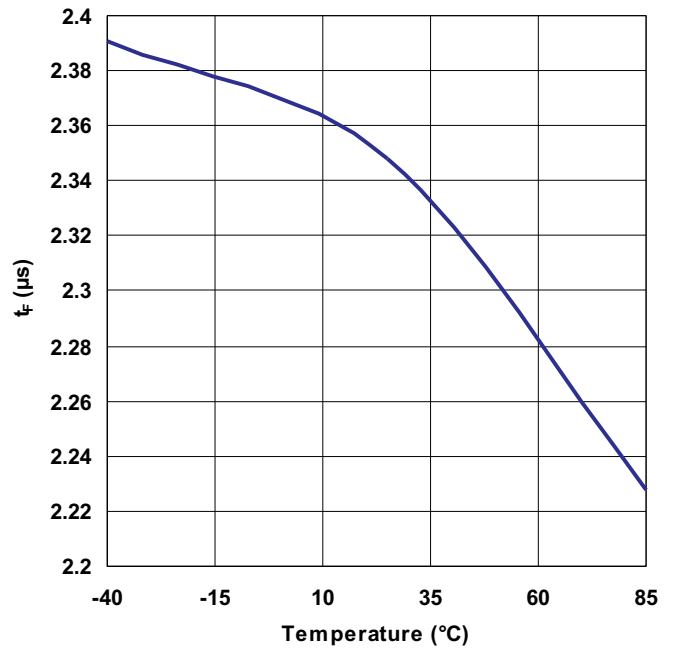

**TYPICAL CHARACTERISTICS (continued)**

**TURN-ON TIME  
vs  
TEMPERATURE**

$V_{IN} = 0.9\text{ V}$ ,  $C_L = 0.1\ \mu\text{F}$ ,  $R_L = 10\ \Omega$

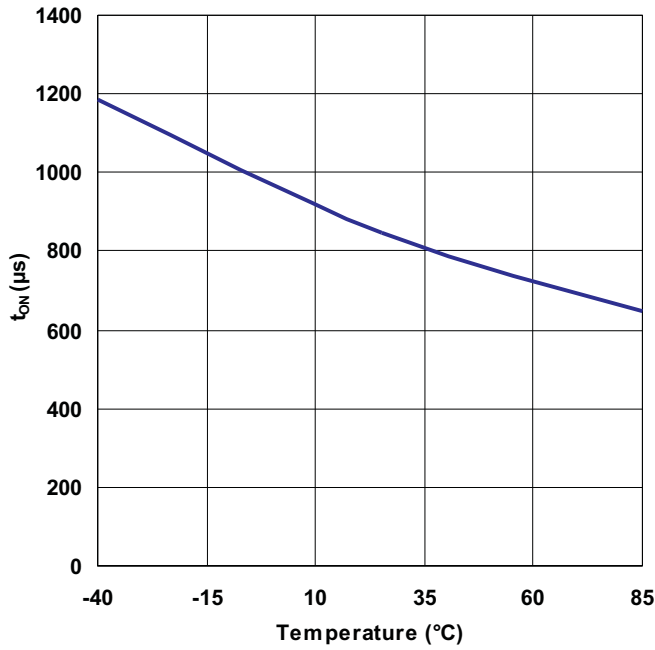

**TURN-OFF TIME  
vs  
TEMPERATURE**

$V_{IN} = 0.9\text{ V}$ ,  $C_L = 0.1\ \mu\text{F}$ ,  $R_L = 10\ \Omega$

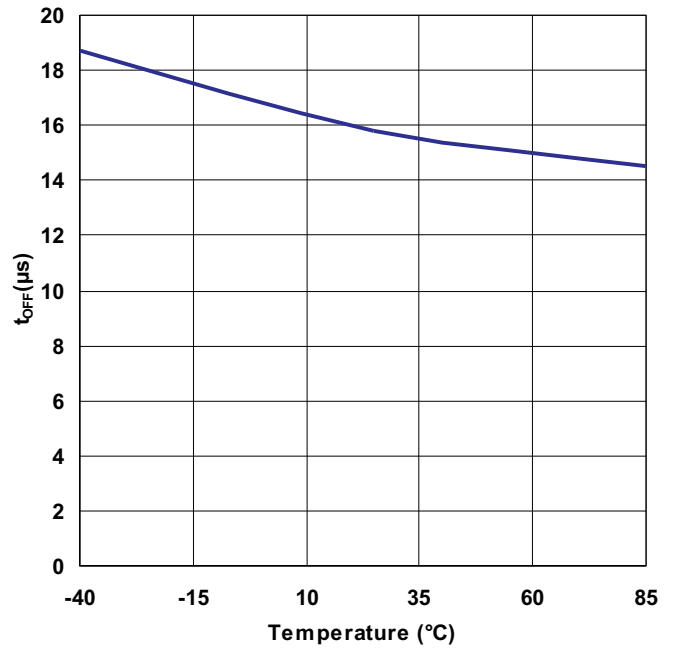

**RISE TIME  
vs  
TEMPERATURE**

$V_{IN} = 0.9\text{ V}$ ,  $C_L = 0.1\ \mu\text{F}$ ,  $R_L = 10\ \Omega$

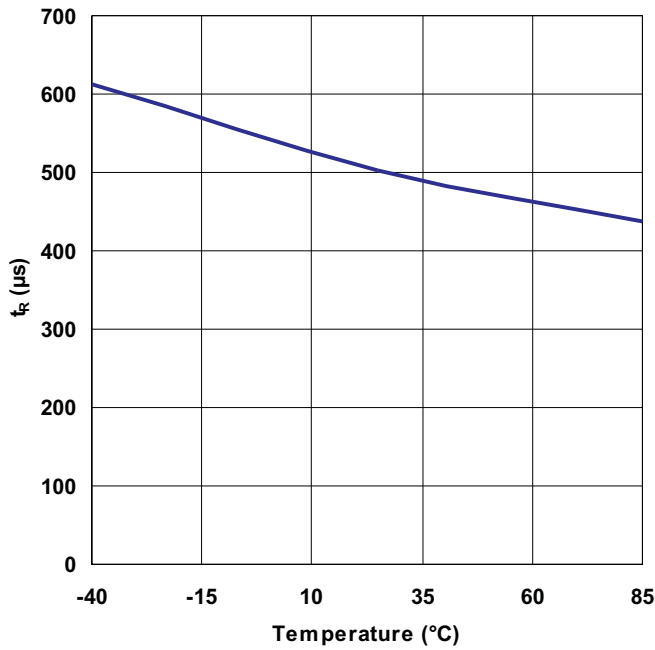

**FALL TIME  
vs  
TEMPERATURE**

$V_{IN} = 0.9\text{ V}$ ,  $C_L = 0.1\ \mu\text{F}$ ,  $R_L = 10\ \Omega$

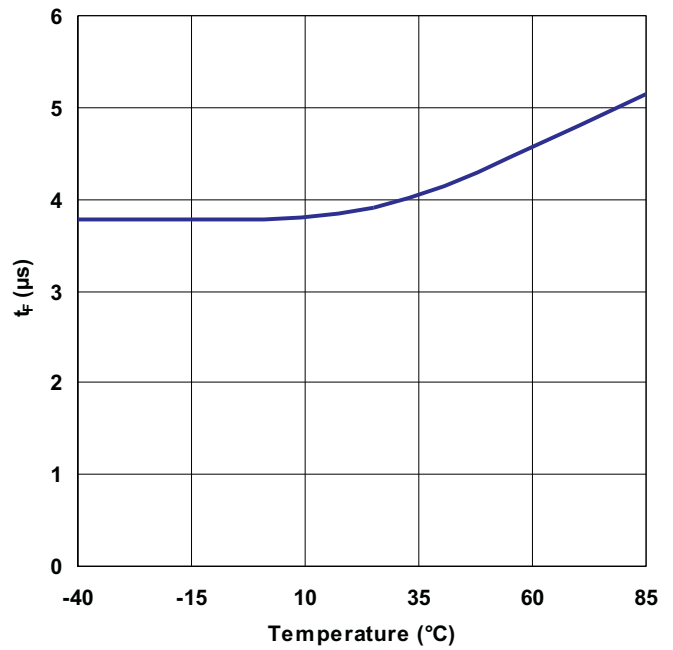

TYPICAL CHARACTERISTICS (continued)

RISE TIME

vs

INPUT VOLTAGE

$C_L = 0.1 \mu\text{F}$ ,  $R_L = 10 \Omega$ ,  $V_{ON} = 1.8 \text{ V}$

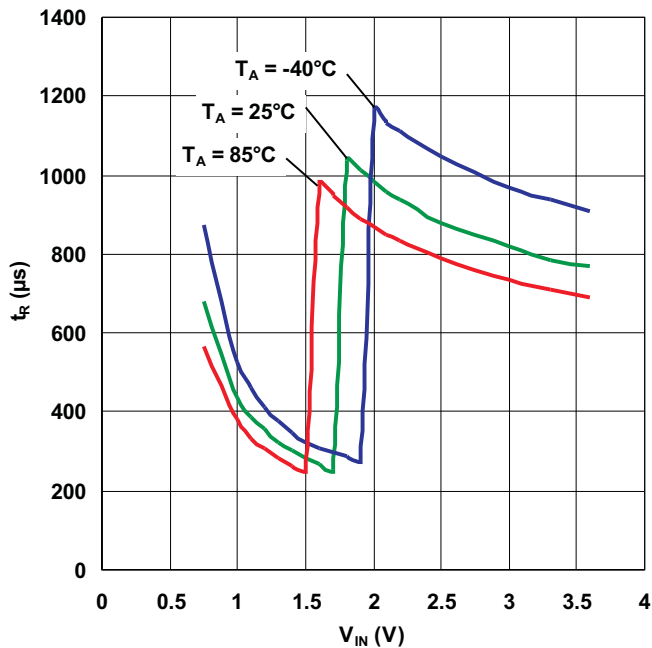

RISE TIME

vs

INPUT VOLTAGE

$C_L = 20 \mu\text{F}$ ,  $R_L = 10 \Omega$ ,  $V_{ON} = 1.8 \text{ V}$

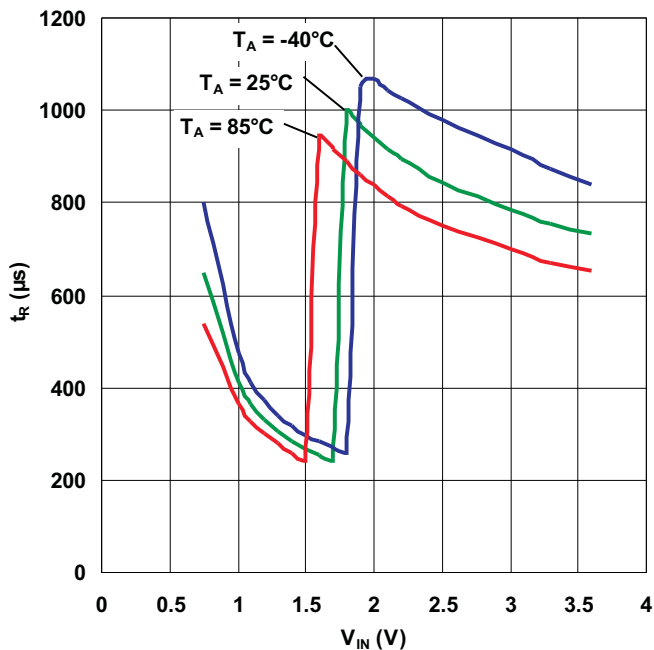

TURN-ON RESPONSE

$C_{IN} = 1 \mu\text{F}$ ,  $C_L = 0.1 \mu\text{F}$ ,  $R_L = 10 \Omega$ ,  $V_{IN} = 0.9 \text{ V}$ ,  $T_A = 25^\circ\text{C}$

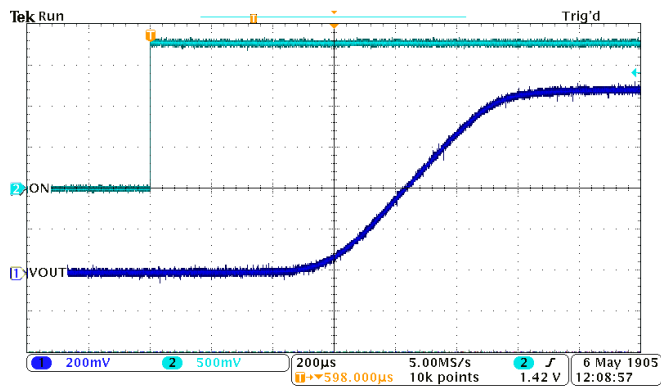

TURN-OFF RESPONSE

$C_{IN} = 1 \mu\text{F}$ ,  $C_L = 0.1 \mu\text{F}$ ,  $R_L = 10 \Omega$ ,  $V_{IN} = 0.9 \text{ V}$ ,  $T_A = 25^\circ\text{C}$

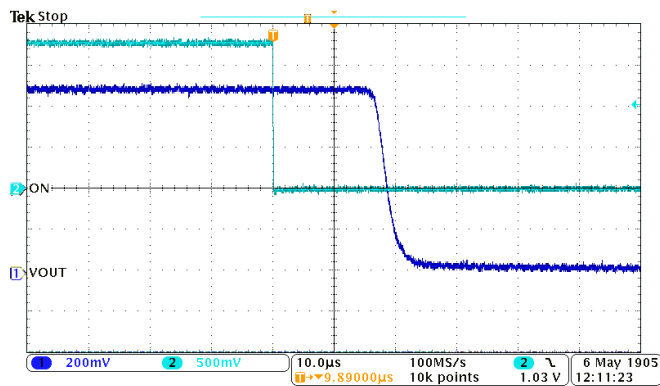

**TYPICAL CHARACTERISTICS (continued)**

**TURN-ON RESPONSE**

$C_{IN} = 47 \mu F, C_L = 20 \mu F, R_L = 10 \Omega, V_{IN} = 0.9 V, T_A = 25^\circ C$

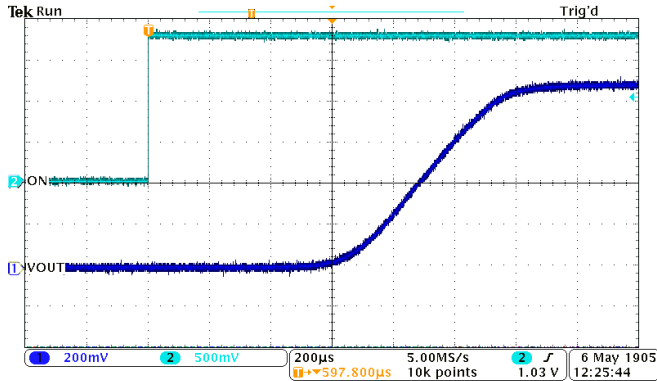

**TURN-OFF RESPONSE**

$C_{IN} = 47 \mu F, C_L = 20 \mu F, R_L = 10 \Omega, V_{IN} = 0.9 V, T_A = 25^\circ C$

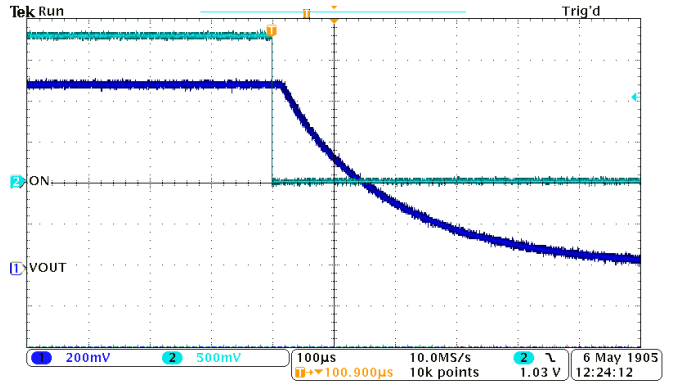

**TURN-ON RESPONSE**

$C_{IN} = 1 \mu F, C_L = 0.1 \mu F, R_L = 10 \Omega, V_{IN} = 3.6 V, T_A = 25^\circ C$

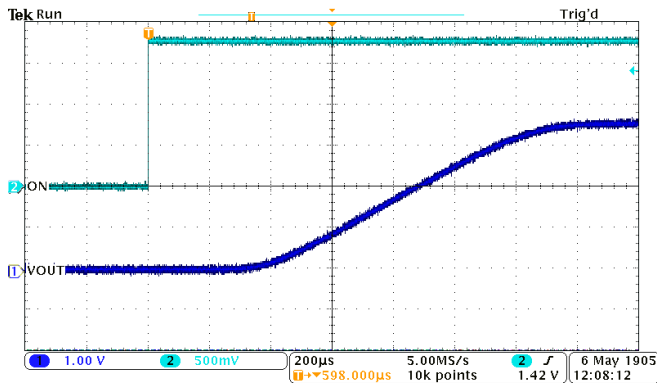

**TURN-OFF RESPONSE**

$C_{IN} = 1 \mu F, C_L = 0.1 \mu F, R_L = 10 \Omega, V_{IN} = 3.6 V, T_A = 25^\circ C$

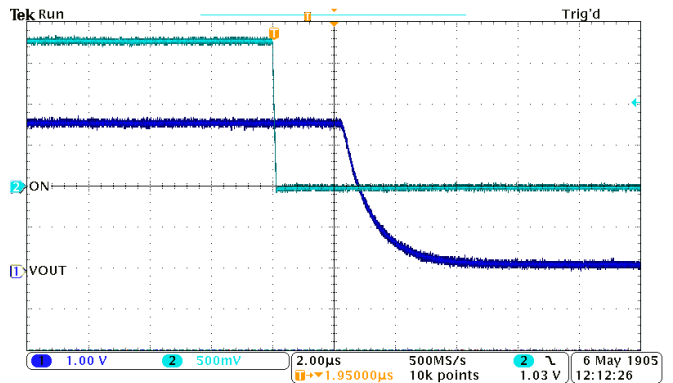

**TURN-ON RESPONSE**

$C_{IN} = 47 \mu F, C_L = 20 \mu F, R_L = 10 \Omega, V_{IN} = 3.6 V, T_A = 25^\circ C$

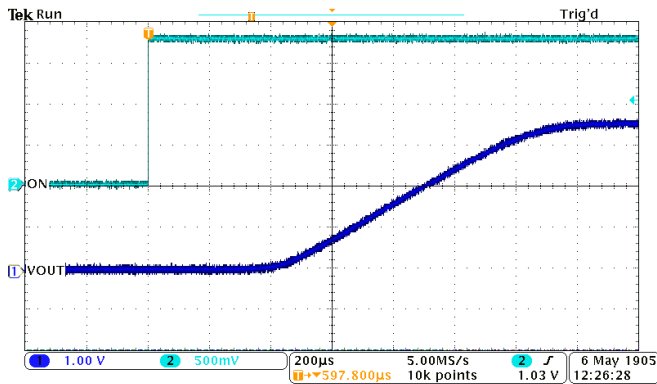

**TURN-OFF RESPONSE**

$C_{IN} = 47 \mu F, C_L = 20 \mu F, R_L = 10 \Omega, V_{IN} = 3.6 V, T_A = 25^\circ C$

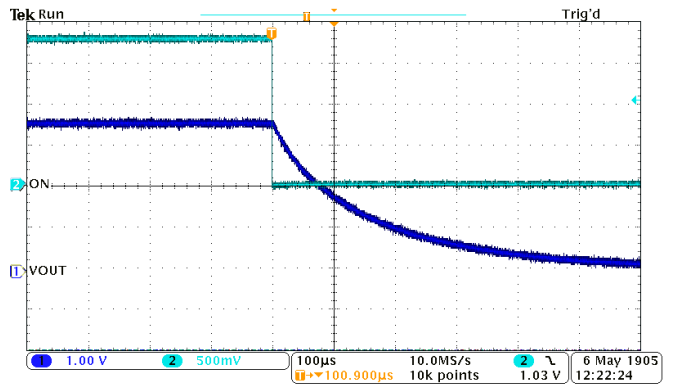

## APPLICATION INFORMATION

### ON/OFF Control

The ON pin controls the state of the switch. Asserting ON high enables the switch. ON is active high and has a low threshold, making it capable of interfacing with low-voltage signals. The ON pin is compatible with standard GPIO logic threshold. It can be used with any microcontroller with 1.2-V, 1.8-V, 2.5-V or 3.3-V GPIOs.

### Input Capacitor

To limit the voltage drop on the input supply caused by transient in-rush currents when the switch turns on into a discharged load capacitor or short-circuit, a capacitor needs to be placed between  $V_{IN}$  and GND. A 1- $\mu$ F ceramic capacitor,  $C_{IN}$ , placed close to the pins is usually sufficient. Higher values of  $C_{IN}$  can be used to further reduce the voltage drop.

### Output Capacitor

Due to the integral body diode in the NMOS switch, a  $C_{IN}$  greater than  $C_L$  is highly recommended. A  $C_L$  greater than  $C_{IN}$  can cause  $V_{OUT}$  to exceed  $V_{IN}$  when the system supply is removed. This could result in current flow through the body diode from  $V_{OUT}$  to  $V_{IN}$ . A  $C_{IN}$  to  $C_L$  ratio of 10 to 1 is recommended for minimizing  $V_{IN}$  dip caused by inrush currents during startup.

### Output Pulldown

The output pulldown is active when the user is turning off the main pass FET. The pulldown discharges the output rail to approximately 10% of the rail, then the output pulldown is automatically disconnected to optimize the shutdown current.

### Board Layout

For best performance, all traces should be as short as possible. To be most effective, the input and output capacitors should be placed close to the device to minimize the effects that parasitic trace inductances may have on normal and short-circuit operation. Using wide traces for  $V_{IN}$ ,  $V_{OUT}$ , and GND helps minimize the parasitic electrical effects along with minimizing the case to ambient thermal impedance.

**REVISION HISTORY**

<b>Changes from Original (November 2009) to Revision A</b>	<b>Page</b>
• Changed Ultra-Low ON Resistance list in Features .....	1
• Changed $r_{ON}$ (TYP) in Feature List table from 5.7m $\Omega$ to 18.3m $\Omega$ . .....	1
• Changed block diagram to show a PMOS FET instead of an NMOS FET. ....	3
• Changed $V_{IL}$ lower end $V_{IN}$ value from (0.75 V to 2.5 V) to (0.75V to 2.49 V). ....	4
• Changed the way $I_{IN}$ is specified. ....	5
• Changed the name of the parameter $I_{IN(OFF)}$ to $I_{IN(LEAK)}$ . The test condition also changed from OUT = OPEN to OUT = 0V. ....	5
• Changed $r_{ON}$ values. ....	5
• Changed Test Circuit diagram in the PARAMETER MEASUREMENT INFORMATION section. ....	6
• Changed graphs in the TYPICAL CHARACTERISTICS section. ....	7

<b>Changes from Revision A (May 2011) to Revision B</b>	<b>Page</b>
• Changed parametric (MAX ) values for $I_{IN}$ Quiescent and $I_{IN(LEAK)}$ . ....	5

**PACKAGING INFORMATION**

Orderable Device	Status <sup>(1)</sup>	Package Type	Package Drawing	Pins	Package Qty	Eco Plan <sup>(2)</sup>	Lead/ Ball Finish	MSL Peak Temp <sup>(3)</sup>	Samples (Requires Login)
TPS22924CYZPR	ACTIVE	DSBGA	YZP	6	3000	Green (RoHS & no Sb/Br)	SNAGCU	Level-1-260C-UNLIM	
TPS22924CYZPT	ACTIVE	DSBGA	YZP	6	250	Green (RoHS & no Sb/Br)	SNAGCU	Level-1-260C-UNLIM	

<sup>(1)</sup> The marketing status values are defined as follows:

**ACTIVE:** Product device recommended for new designs.

**LIFEBUY:** TI has announced that the device will be discontinued, and a lifetime-buy period is in effect.

**NRND:** Not recommended for new designs. Device is in production to support existing customers, but TI does not recommend using this part in a new design.

**PREVIEW:** Device has been announced but is not in production. Samples may or may not be available.

**OBsolete:** TI has discontinued the production of the device.

<sup>(2)</sup> Eco Plan - The planned eco-friendly classification: Pb-Free (RoHS), Pb-Free (RoHS Exempt), or Green (RoHS & no Sb/Br) - please check <http://www.ti.com/productcontent> for the latest availability information and additional product content details.

**TBD:** The Pb-Free/Green conversion plan has not been defined.

**Pb-Free (RoHS):** TI's terms "Lead-Free" or "Pb-Free" mean semiconductor products that are compatible with the current RoHS requirements for all 6 substances, including the requirement that lead not exceed 0.1% by weight in homogeneous materials. Where designed to be soldered at high temperatures, TI Pb-Free products are suitable for use in specified lead-free processes.

**Pb-Free (RoHS Exempt):** This component has a RoHS exemption for either 1) lead-based flip-chip solder bumps used between the die and package, or 2) lead-based die adhesive used between the die and leadframe. The component is otherwise considered Pb-Free (RoHS compatible) as defined above.

**Green (RoHS & no Sb/Br):** TI defines "Green" to mean Pb-Free (RoHS compatible), and free of Bromine (Br) and Antimony (Sb) based flame retardants (Br or Sb do not exceed 0.1% by weight in homogeneous material)

<sup>(3)</sup> MSL, Peak Temp. -- The Moisture Sensitivity Level rating according to the JEDEC industry standard classifications, and peak solder temperature.

**Important Information and Disclaimer:** The information provided on this page represents TI's knowledge and belief as of the date that it is provided. TI bases its knowledge and belief on information provided by third parties, and makes no representation or warranty as to the accuracy of such information. Efforts are underway to better integrate information from third parties. TI has taken and continues to take reasonable steps to provide representative and accurate information but may not have conducted destructive testing or chemical analysis on incoming materials and chemicals. TI and TI suppliers consider certain information to be proprietary, and thus CAS numbers and other limited information may not be available for release.

In no event shall TI's liability arising out of such information exceed the total purchase price of the TI part(s) at issue in this document sold by TI to Customer on an annual basis.

## TAPE AND REEL INFORMATION



### QUADRANT ASSIGNMENTS FOR PIN 1 ORIENTATION IN TAPE



\*All dimensions are nominal

Device	Package Type	Package Drawing	Pins	SPQ	Reel Diameter (mm)	Reel Width W1 (mm)	A0 (mm)	B0 (mm)	K0 (mm)	P1 (mm)	W (mm)	Pin1 Quadrant
TPS22924CYZPR	DSBGA	YZP	6	3000	178.0	9.2	1.02	1.52	0.63	4.0	8.0	Q1
TPS22924CYZPT	DSBGA	YZP	6	250	178.0	9.2	1.02	1.52	0.63	4.0	8.0	Q1



**TAPE AND REEL BOX DIMENSIONS**



\*All dimensions are nominal

Device	Package Type	Package Drawing	Pins	SPQ	Length (mm)	Width (mm)	Height (mm)
TPS22924CZPR	DSBGA	YZP	6	3000	220.0	220.0	35.0
TPS22924CZPT	DSBGA	YZP	6	250	220.0	220.0	35.0

YZP (R-XBGA-N6)

DIE-SIZE BALL GRID ARRAY

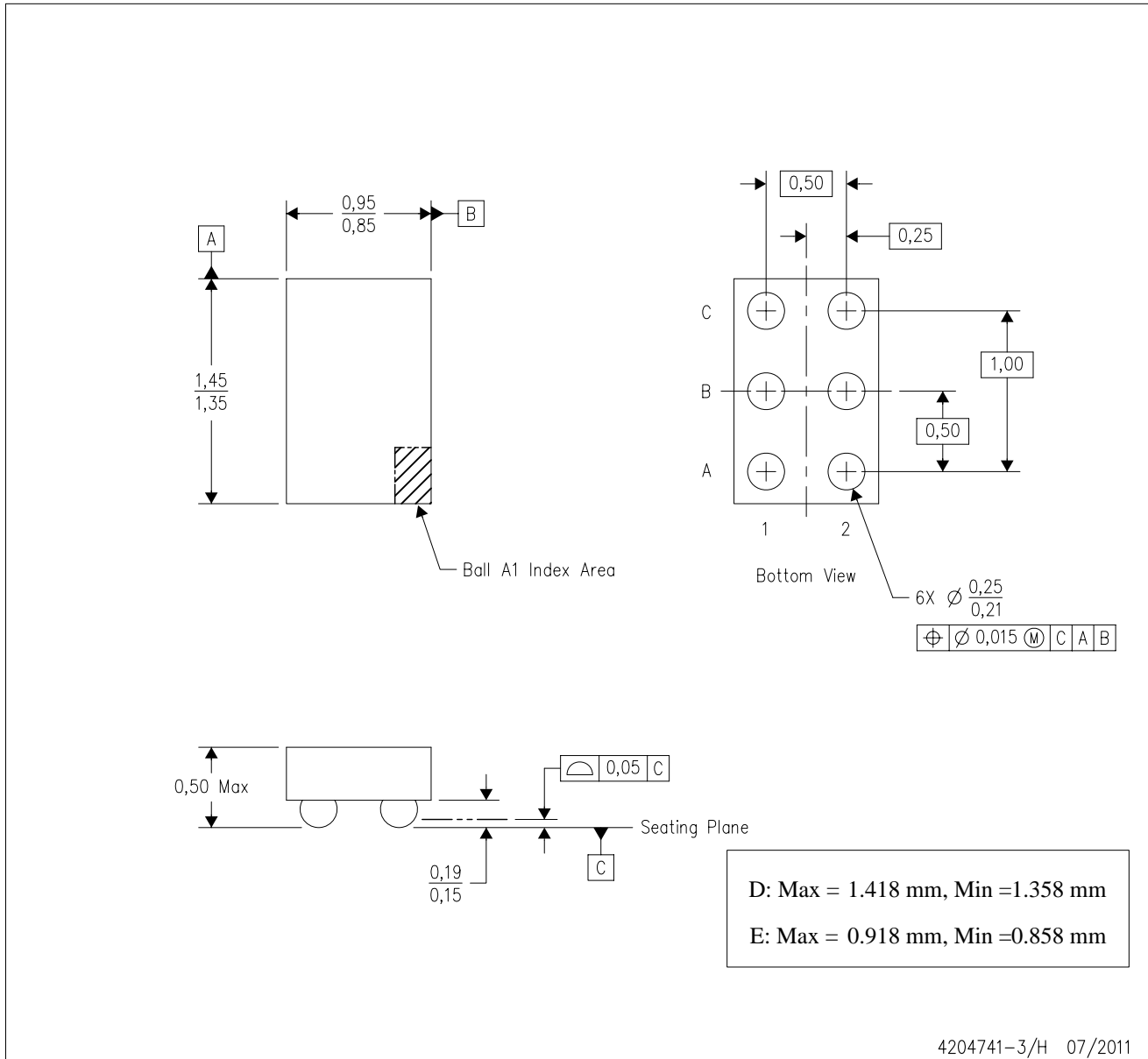

- NOTES:
- All linear dimensions are in millimeters. Dimensioning and tolerancing per ASME Y14.5M-1994.
  - This drawing is subject to change without notice.
  - NanoFree™ package configuration.
  - This package is a Pb-free solder ball design. Refer to the 6 YEP package (drawing 4204725) for tin-lead (SnPb).

## IMPORTANT NOTICE

Texas Instruments Incorporated and its subsidiaries (TI) reserve the right to make corrections, modifications, enhancements, improvements, and other changes to its products and services at any time and to discontinue any product or service without notice. Customers should obtain the latest relevant information before placing orders and should verify that such information is current and complete. All products are sold subject to TI's terms and conditions of sale supplied at the time of order acknowledgment.

TI warrants performance of its hardware products to the specifications applicable at the time of sale in accordance with TI's standard warranty. Testing and other quality control techniques are used to the extent TI deems necessary to support this warranty. Except where mandated by government requirements, testing of all parameters of each product is not necessarily performed.

TI assumes no liability for applications assistance or customer product design. Customers are responsible for their products and applications using TI components. To minimize the risks associated with customer products and applications, customers should provide adequate design and operating safeguards.

TI does not warrant or represent that any license, either express or implied, is granted under any TI patent right, copyright, mask work right, or other TI intellectual property right relating to any combination, machine, or process in which TI products or services are used. Information published by TI regarding third-party products or services does not constitute a license from TI to use such products or services or a warranty or endorsement thereof. Use of such information may require a license from a third party under the patents or other intellectual property of the third party, or a license from TI under the patents or other intellectual property of TI.

Reproduction of TI information in TI data books or data sheets is permissible only if reproduction is without alteration and is accompanied by all associated warranties, conditions, limitations, and notices. Reproduction of this information with alteration is an unfair and deceptive business practice. TI is not responsible or liable for such altered documentation. Information of third parties may be subject to additional restrictions.

Resale of TI products or services with statements different from or beyond the parameters stated by TI for that product or service voids all express and any implied warranties for the associated TI product or service and is an unfair and deceptive business practice. TI is not responsible or liable for any such statements.

TI products are not authorized for use in safety-critical applications (such as life support) where a failure of the TI product would reasonably be expected to cause severe personal injury or death, unless officers of the parties have executed an agreement specifically governing such use. Buyers represent that they have all necessary expertise in the safety and regulatory ramifications of their applications, and acknowledge and agree that they are solely responsible for all legal, regulatory and safety-related requirements concerning their products and any use of TI products in such safety-critical applications, notwithstanding any applications-related information or support that may be provided by TI. Further, Buyers must fully indemnify TI and its representatives against any damages arising out of the use of TI products in such safety-critical applications.

TI products are neither designed nor intended for use in military/aerospace applications or environments unless the TI products are specifically designated by TI as military-grade or "enhanced plastic." Only products designated by TI as military-grade meet military specifications. Buyers acknowledge and agree that any such use of TI products which TI has not designated as military-grade is solely at the Buyer's risk, and that they are solely responsible for compliance with all legal and regulatory requirements in connection with such use.

TI products are neither designed nor intended for use in automotive applications or environments unless the specific TI products are designated by TI as compliant with ISO/TS 16949 requirements. Buyers acknowledge and agree that, if they use any non-designated products in automotive applications, TI will not be responsible for any failure to meet such requirements.

Following are URLs where you can obtain information on other Texas Instruments products and application solutions:

### Products

Audio	<a href="http://www.ti.com/audio">www.ti.com/audio</a>
Amplifiers	<a href="http://amplifier.ti.com">amplifier.ti.com</a>
Data Converters	<a href="http://dataconverter.ti.com">dataconverter.ti.com</a>
DLP® Products	<a href="http://www.dlp.com">www.dlp.com</a>
DSP	<a href="http://dsp.ti.com">dsp.ti.com</a>
Clocks and Timers	<a href="http://www.ti.com/clocks">www.ti.com/clocks</a>
Interface	<a href="http://interface.ti.com">interface.ti.com</a>
Logic	<a href="http://logic.ti.com">logic.ti.com</a>
Power Mgmt	<a href="http://power.ti.com">power.ti.com</a>
Microcontrollers	<a href="http://microcontroller.ti.com">microcontroller.ti.com</a>
RFID	<a href="http://www.ti-rfid.com">www.ti-rfid.com</a>
RF/IF and ZigBee® Solutions	<a href="http://www.ti.com/lprf">www.ti.com/lprf</a>

### Applications

Communications and Telecom	<a href="http://www.ti.com/communications">www.ti.com/communications</a>
Computers and Peripherals	<a href="http://www.ti.com/computers">www.ti.com/computers</a>
Consumer Electronics	<a href="http://www.ti.com/consumer-apps">www.ti.com/consumer-apps</a>
Energy and Lighting	<a href="http://www.ti.com/energy">www.ti.com/energy</a>
Industrial	<a href="http://www.ti.com/industrial">www.ti.com/industrial</a>
Medical	<a href="http://www.ti.com/medical">www.ti.com/medical</a>
Security	<a href="http://www.ti.com/security">www.ti.com/security</a>
Space, Avionics and Defense	<a href="http://www.ti.com/space-avionics-defense">www.ti.com/space-avionics-defense</a>
Transportation and Automotive	<a href="http://www.ti.com/automotive">www.ti.com/automotive</a>
Video and Imaging	<a href="http://www.ti.com/video">www.ti.com/video</a>
Wireless	<a href="http://www.ti.com/wireless-apps">www.ti.com/wireless-apps</a>

TI E2E Community Home Page

[e2e.ti.com](http://e2e.ti.com)

Mailing Address: Texas Instruments, Post Office Box 655303, Dallas, Texas 75265  
Copyright © 2011, Texas Instruments Incorporated