



Application Tooling > Hand Crimping Tools



Tool Grade: **Commercial Crimp Tooling**  
 Ratchet Configuration: **Operator Releasable & Adjustable**  
 Die Sets Type: **Removable/Interchangeable**  
 Specification Type: **TE Product Specification (114-)**  
 TE Certification: **No**

### Features

#### Other

Crimp Form-Wire Barrel Type	Open Barrel - F Crimp
Tool Grade	Commercial Crimp Tooling
Ratchet Configuration	Operator Releasable & Adjustable
Die Sets Type	Removable/Interchangeable
Specification Type	TE Product Specification (114-)
TE Certification	No
Power Technology Type	Manual
Tooling Type	SDE Crimp Die Set

### Product Compliance

[For compliance documentation, visit the product page on TE.com>](#)

EU RoHS Directive 2011/65/EU	Out of Scope
EU ELV Directive 2000/53/EC	Out of Scope
China RoHS 2 Directive MIIT Order No 32, 2016	Not reviewed for China RoHS compliance
EU REACH Regulation (EC) No. 1907/2006	



Current ECHA Candidate List: JUNE 2022  
(224)

Candidate List Declared Against: JAN 2021  
(211)

Does not contain REACH SVHC

Halogen Content	Not Yet Reviewed for halogen content
Solder Process Capability	Not applicable for solder process capability



Product Compliance Disclaimer

This information is provided based on reasonable inquiry of our suppliers and represents our current actual knowledge based on the information they provided. This information is subject to change. The part numbers that TE has identified as EU RoHS compliant have a maximum concentration of 0.1% by weight in homogenous materials for lead, hexavalent chromium, mercury, PBB, PBDE, DBP, BBP, DEHP, DIBP, and 0.01% for cadmium, or qualify for an exemption to these limits as defined in the Annexes of Directive 2011/65/EU (RoHS2). Finished electrical and electronic equipment products will be CE marked as required by Directive 2011/65/EU. Components may not be CE marked. Additionally, the part numbers that TE has identified as EU ELV compliant have a maximum concentration of 0.1% by weight in homogenous materials for lead, hexavalent chromium, and mercury, and 0.01% for cadmium, or qualify for an exemption to these limits as defined in the Annexes of Directive 2000/53/EC (ELV). Regarding the REACH Regulation, the information TE provides on SVHC in articles for this part number is based on the latest European Chemicals Agency (ECHA) 'Guidance on requirements for substances in articles' posted at this URL: <https://echa.europa.eu/guidance-documents/guidance-on-reach>

### Compatible Parts

 <p>REPRESENTATION ONLY. DIE SET MAY VARY. TE</p> <p>TE Part # 2063538-1 SDE MICROTIMER 0.2-1.5mm<sup>2</sup> ASSY</p>	 <p>TE</p> <p>TE Part # 2362810-1 SDE CRIMP HAND TOOL FRAME W /O DIES</p>	<p>TE Part # 929927-4 MT1 REC 1.6 Contact SRC Au (LP)</p>	<p>TE Part # 929951-1 MT1 REC 1.6 Contact SRC Sn (LP)</p>
---	--	---	---

### Customers Also Bought

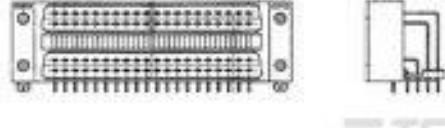
 <p>TE</p> <p>TE Part #T1329320140-000 H32A-TG-M40</p>	 <p>TE</p> <p>TE Part #T2071164101-000 H16BP-T4-M DOCKING FRAME_FLOATING</p>	 <p>TE</p> <p>TE Part #T2071164201-000 H16BP-T4-F DOCKING FRAME_FIXED</p>	 <p>TE</p> <p>TE Part #900412-2 PC I/O RETENTION LEG ASSY 80P</p>
---	---	--	--



## Documents

### Datasheets & Catalog Pages

#### Bottoming Dies

English

### Instruction Sheets

#### Instruction Sheet (U.S.)

English