

M12 Y-distributor / M8 female 90°

PUR 3x0.25 ye UL/CSA+drag chain 0.3m

Male straight, to females 90°
Y-connector M12 - M8, 4-pole

Plastic housings with good resistance against chemicals and oils. The resistance to aggressive media should be individually tested for your application. Further details on request. Further cable lengths on request.

[Link to Product](#)

Illustration

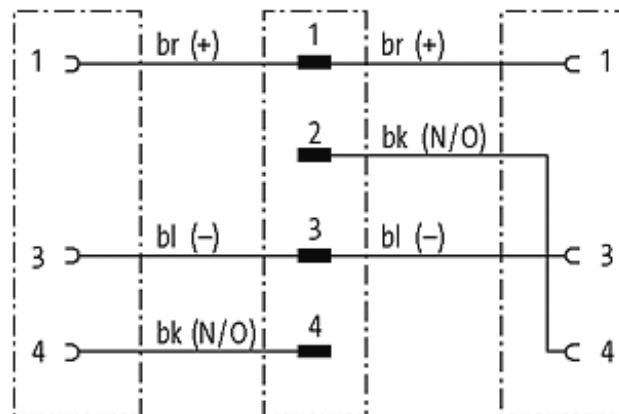
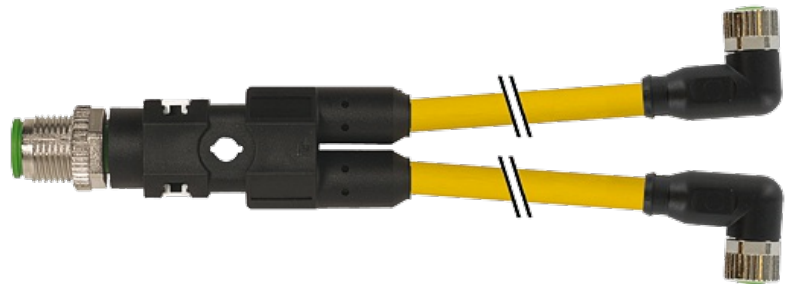

Y-Male

Females

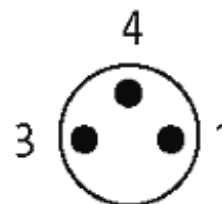

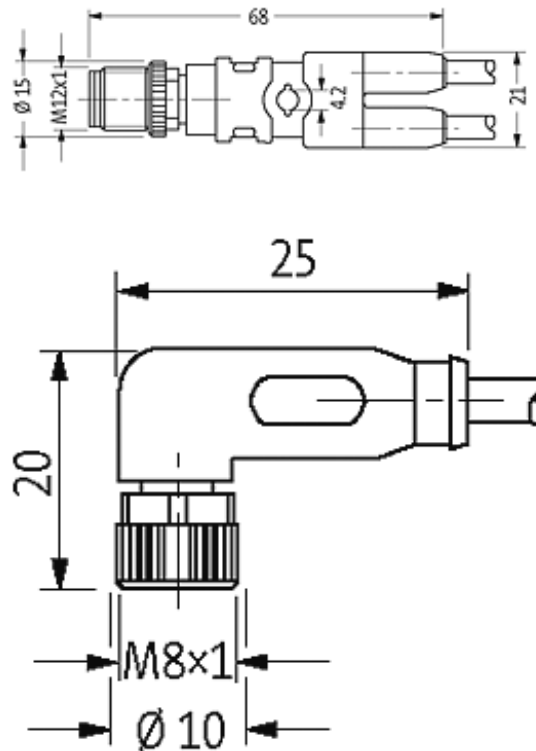

Product may differ from Image

Approvals



* only for products with UL/CSA approved cable

Form

40841

Technical Data

Operating voltage	max. 60 V AC/DC
Operating current per contact	max. 4 A
Locking of ports	Screw thread M8/M12 × 1 mm (recommended torque 0.4/0.6 Nm), self-securing
Protection	IP67 inserted and tightened (EN 60529)

Cables

Cable number	030
No./diameter of wires	3 × 0.25 mm ²
Wire isolation	PP (br, bl, bk)
C-track properties	5 Mio.
Torsion	2 Mio. ± 180°/m
Jacket Color	yellow
Shore hardness outer jacket	90 ± 5A

The information in this brochure has been compiled with the utmost care.

Liability for the correctness completeness and topicality of the information is restricted to gross negligence. Version: 05/15

Material (jacket)	PUR (UL/CSA)
Outer diameter	approx. 4.3 mm
Bend radius (fixed)	5 × outer Ø
Bend radius (moving)	10 × outer Ø
Temperature range (fixed)	-40...+80 °C
Temperature range (mobile)	-25...+80 °C

General data

Temperature range	-25...+85 °C, depending on cable quality
-------------------	--

Commercial data

country of origin	DE
customs tariff number	85444290
minimum order quantity	1