

Miniature Power Relays

MY/MYK/MYQ-MYH

Best-selling, general-purpose relays that can be selected based on operating environment and application

- Wiring work can be shortened by as much as 60%* compared to conventional screw terminal sockets by combining with push-in plus terminal sockets (PYF-□-PU) that feature light insertion force and strong pull-out strength to achieve less wiring work.
- In addition to our standard type (MY), an abundant lineup of models including latching relays that retain contact operation status (MYK) and sealed relays suitable for environments where dust and corrosive gases are present (MYQ/MYH) are also available.
- Selection is possible to suit the application, such as models with operation indicators and models with latching levers (MY plug-in terminals).

* When both push-in plus terminals and screw terminal sockets are combined with plug-in terminal types (according to actual OMRON measurements as of November 2015)

 Refer to *Safety Precautions* on pages 54 to 55 and *Safety Precautions for All Relays*.



Refer to the standards certifications and compliance section of your OMRON website for the latest information on certified models.

Miniature Power Relay Types

- MY Miniature Power Relays From page 3
- MYK Miniature Power Latching Relays..... From page 24
- MYQ/MYH Miniature Power Sealed Relays..... From page 29

Common Information

- Common Options (Order Separately)..... From page 35
- Common Safety Precautions From page 54

MY

MYK

MYQ-MYH

Common Options (Order Separately)

Common Precautions

MY/MYK/MYQ-MYH

Model List

Miniature Power Relays: MY

Classification	Number of poles	Contacts	Plug-in terminals			PCB terminals	Case-surface mounting	
				With operation indicator				
					With latching lever			
Standard models (compliant with Electrical Appliances and Material Safety Act)	2	Single	MY2	MY2N	MY2IN(S)	MY2-02	MY2F	
		Bifurcated	MY2Z	MY2ZN				
	3	Single	MY3	MY3N		MY3-02	MY3F	
		4	Single	MY4	MY4N	MY4IN(S)	MY4-02	MY4F
			Bifurcated	MY4Z	MY4ZN	MY4ZIN(S)	MY4Z-02	MY4ZF
	Crossbar bifurcated	MY4Z-CBG	MY4ZN-CBG					
Models with built-in diode for coil surge absorption (compliant with Electrical Appliances and Material Safety Act)	2	Single	MY2-D	MY2N-D2	MY2IN-D2(S)			
		Bifurcated	MY2Z-D	MY2ZN-D2				
	3	Single	MY3-D	MY3N-D2				
		4	Single	MY4-D	MY4N-D2	MY4IN-D2(S)		
Bifurcated	MY4Z-D		MY4ZN-D2	MY4ZIN-D2(S)				
Models with built-in CR circuit for coil surge absorption (compliant with Electrical Appliances and Material Safety Act)	2	Single	MY2-CR	MY2N-CR				
		Bifurcated	MY2Z-CR	MY2ZN-CR				
	4	Single	MY4-CR	MY4N-CR	MY4IN-CR(S)			
		Bifurcated	MY4Z-CR	MY4ZN-CR	MY4ZIN-CR(S)			

- Note: 1. The models in this table are UL/CSA certified. This is indicated with a certification mark on the products. (Except crossbar bifurcated models MY4Z-CBG and MY4ZN-CBG)
2. The standard models with plug-in terminals, models with built-in diodes for coil surge absorption, and models with built-in CR circuits for coil surge absorption were used in combination with the PYF□A-E, PYF□S and PYF□-PU for the EC Declaration of Conformity. These products display the CE Marking.

Miniature Power Latching Relays (MYK)

Classification	Number of poles	Contacts	Plug-in terminals		PCB terminals
				With operation indicator	
Standard models	2	Single	MY2K		MY2K-02

Miniature Power Sealed Relays (MYQ/MYH)

Classification	Number of poles	Contacts	Plug-in terminals		PCB terminals
				With operation indicator	
Plastic Sealed Relays	4	Single	MYQ4	MYQ4N	MYQ4-02
		Bifurcated	MYQ4Z		MYQ4Z-02
Hermetically Sealed Relays	4	Single	MY4H		MY4H-0
		Bifurcated	MY4ZH		MY4ZH-0

Refer to Front-connecting Sockets and Back-connecting Sockets in *Common Options (Order Separately)* on pages 35 and 37 for main unit and socket combinations.

MY

MYK

MYQ-MYH

Common Options (Order Separately)

Common Precautions

Best-selling, general-purpose relays

- AC/DC coil voltage specifications can now be more easily distinguished thanks to the use of color-coded coil tape and operation indicators (LED).
- Latching levers convenient for circuit checking and types equipped with mechanical operation indicators and operation indicators for monitoring operation status are also available.
- Contact materials and contact structures can be selected based on contact reliability and corrosion resistance.

*Voltage is printed on white tape in the case of the Standard 3-pole model (MY3).

 Refer to *Safety Precautions* on pages 54 to 55 and *Safety Precautions for All Relays*.

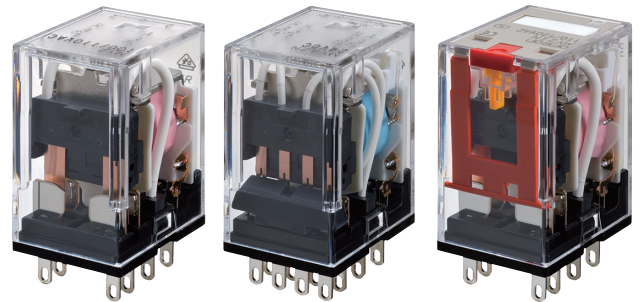

Refer to the standards certifications and compliance section of your OMRON website for the latest information on certified models.

Features

1. More easily distinguished AC/DC coil voltage specifications

- Distinguished using color-coded coil tape*
- Distinguished using color-coded operation indicators (LED)

* Voltage is printed on white tape in the case of the Standard 3-pole model (MY3).

Example: MY2



Coil tape
Pink = AC voltage AC coil specification

Example: MY4



Coil tape
Blue = DC voltage DC coil specification

Example: MY4



Operation indicator (LED)
Red = AC voltage AC coil specification

Example: MY4



Operation indicator (LED)
Green = DC voltage DC coil specification

2. Latching levers convenient for circuit checking and types equipped with mechanical operation indicators and operation indicators for monitoring operation status are available.

- Latching lever operating procedure
- Mechanical operation indicator/LED operation indicator

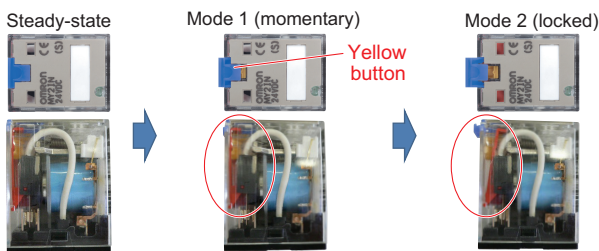

Sliding the lever to the first stage and pressing the yellow button using an insulated flat-blade screwdriver, etc., will operate the contacts.



Sliding the lever to the second stage will lock the contacts in the operating position.

Mechanical operation indicator (two locations on left and right) Contacts ON (coil energization)

LED operation indicator
AC coil specification: Red
DC coil specification: Green

AC coil specification (LED: Red)

3. Contact materials and contact structures can be selected based on contact reliability and corrosion resistance.

Contact reliability			Corrosion resistance		
	Contact structure		Contact material	Typical model	
High ↑	Crossbar bifurcated contacts 	High ↑	Au cladding + AgPd	MY4Z-CBG	
	Bifurcated contacts 		Au cladding + Ag alloy Au plating + Ag alloy	MY4Z MY2Z	
Low ↓	Single contacts 	Low ↓	Au cladding + Ag alloy	MY4	
			Ag alloy	MY2	

Model Number Structure

Model Number Legend

● Plug-in Terminals

Standard models

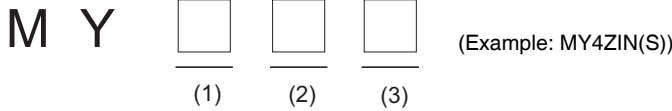

(1) Number of poles

- 2: 2-pole
- 3: 3-pole
- 4: 4-pole

(2) Contacts

- None: Single
- Z: Bifurcated
- Z-CBG: Crossbar bifurcated

(3) Options

- None: None
- N: With operation indicator
- IN(S): With operation indicator/latching lever

Models with built-in diode for coil surge absorption

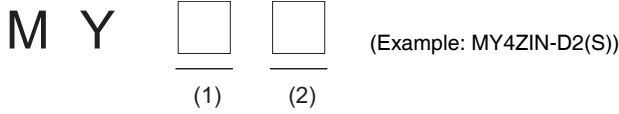

(1) Number of poles/contacts

- 2: 2-pole, single contacts
- 2Z: 2-pole, bifurcated contacts
- 3: 3-pole, single contacts
- 4: 4-pole, single contacts
- 4Z: 4-pole, bifurcated contacts

(2) Options

- D: Models with built-in diode for coil surge absorption
- N-D2: Built-in diode for coil surge absorption, with operation indicator
- IN-D2(S): Built-in diode for coil surge absorption, with operation indicator/latching lever

Models with built-in CR circuit for coil surge absorption

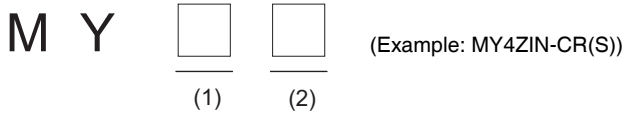

(1) Number of poles/contacts

- 2: 2-pole, single contacts
- 2Z: 2-pole, bifurcated contacts
- 4: 4-pole, single contacts
- 4Z: 4-pole, bifurcated contacts

(2) Options

- CR: Models with built-in CR circuit for coil surge absorption
- N-CR: Built-in CR circuit for coil surge absorption, with operation indicator
- IN-CR(S): Built-in CR circuit for coil surge absorption, with operation indicator/latching lever*
- *4-pole: Single/bifurcated contacts only

● PCB terminals/case surface mounted

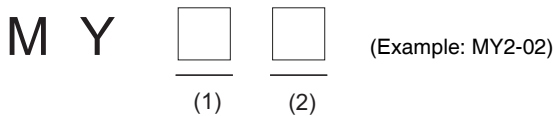

(1) Number of poles/contacts

- 2: 2-pole, single contacts
- 3: 3-pole, single contacts
- 4: 4-pole, single contacts
- 4Z: 4-pole, bifurcated contacts

(2) Terminals

- 02: PCB terminals
- F: Case-surface mounting

MY

MYK

MYQ-MYH

Common Options (Order Separately)

Common Precautions

Ordering Information

When your order, specify the rated voltage.

● Plug-in Terminals

Without operation indicator

Classification	Number of poles	Contacts	Model	Rated voltage	
Standard models (compliant with Electrical Appliances and Material Safety Act)	2	Single	MY2	12, 24, 100/110, 110/120, 200/220, 220/240 VAC 12, 24, 48, 100/110 VDC	
		Bifurcated	MY2Z	12, 24, 100/110, 110/120, 200/220, 220/240 VAC 12, 24, 48, 100/110 VDC	
	3	Single	MY3	12, 24, 100/110, 110/120, 200/220, 220/240 VAC 12, 24, 48, 100/110 VDC	
		4	Single	MY4	12, 24, 100/110, 110/120, 200/220, 220/240 VAC 12, 24, 48, 100/110 VDC
	Bifurcated		MY4Z	100/110, 110/120, 200/220, 220/240 VAC 12, 24, 48, 100/110 VDC	
	Crossbar bifurcated		MY4Z-CBG	100/110, 110/120, 200/220 VAC 12, 24, 48, 100/110 VDC	
	Models with built-in diode for coil surge absorption (DC coil specification only)	2	Single	MY2-D	12, 24, 48, 100/110 VDC
			Bifurcated	MY2Z-D	12, 24, 100/110 VDC
3		Single	MY3-D	12, 24, 100/110 VDC	
4		Single	MY4-D	12, 24, 48, 100/110 VDC	
	Bifurcated	MY4Z-D	12, 24, 48, 100/110 VDC		
Models with built-in CR circuit for coil surge absorption (AC coil specification only)	2	Single	MY2-CR	100/110, 110/120, 200/220, 220/240 VAC	
		Bifurcated	MY2Z-CR	100/110, 200/220 VAC,	
	4	Single	MY4-CR	100/110, 110/120, 200/220, 220/240 VAC	
		Bifurcated	MY4Z-CR	100/110, 110/120, 200/220, 220/240 VAC	

MY

MYK

MYQ-MYH

Common Options (Order Separately)

Common Precautions

With operation indicator

Classification	Number of poles	Contacts	Model	Rated voltage	
Standard models (compliant with Electrical Appliances and Material Safety Act)	2	Single	MY2N	12, 24, 100/110, 110/120, 200/220, 220/240 VAC 12, 24, 48, 100/110 VDC	
		Bifurcated	MY2ZN	12, 24, 100/110, 110/120, 200/220, 220/240 VAC 12, 24, 48, 100/110 VDC	
	3	Single	MY3N	12, 24, 100/110, 110/120, 200/220, 220/240 VAC 12, 24, 48, 100/110 VDC	
		Single	MY4N	12, 24, 100/110, 110/120, 200/220, 220/240 VAC 12, 24, 48, 100/110 VDC	
	4	Bifurcated	MY4ZN	24, 100/110, 110/120, 200/220, 220/240 VAC 12, 24, 48, 100/110 VDC	
		Crossbar bifurcated	MY4ZN-CBG	100/110, 200/220 VAC	
				24 VDC	
	Models with built-in diode for coil surge absorption (DC coil specification only)	2	Single	MY2N-D2	12, 24, 48, 100/110 VDC
			Bifurcated	MY2ZN-D2	12, 24, 100/110 VDC
		3	Single	MY3N-D2	12, 24, 100/110 VDC
4			Single	MY4N-D2	12, 24, 48, 100/110 VDC
	Bifurcated	MY4ZN-D2	12, 24, 48, 100/110 VDC		
Models with built-in CR circuit for coil surge absorption (AC coil specification only)	2	Single	MY2N-CR	100/110, 110/120, 200/220, 220/240 VAC	
		Bifurcated	MY2ZN-CR	100/110, 200/220 VAC	
	4	Single	MY4N-CR	100/110, 110/120, 200/220, 220/240 VAC	
		Bifurcated	MY4ZN-CR	100/110, 110/120, 200/220, 220/240 VAC	

With operation indicator/latching lever

Classification	Number of poles	Contacts	Model	Rated voltage
Standard models (compliant with Electrical Appliances and Material Safety Act)	2	Single	MY2IN(S)	100/110, 200/220 VAC 12, 24, 48 VDC
		4	Single	MY4IN(S)
	Bifurcated		MY4ZIN(S)	100/110, 200/220 VAC 12, 24, 48 VDC
	Models with built-in diode for coil surge absorption (DC coil specification only)	2	Single	MY2IN-D2(S)
4			Single	MY4IN-D2(S)
		Bifurcated	MY4ZIN-D2(S)	12, 24, 48 VDC
Models with built-in CR circuit for coil surge absorption (AC coil specification only)	4	Single	MY4IN-CR(S)	100/110, 200/220 VAC
		Bifurcated	MY4ZIN-CR(S)	100/110, 200/220 VAC

MY

MYK

MYQ-MYH

Common Options (Order Separately)

Common Precautions

●PCB terminals

Classification	Number of poles	Contacts	Model	Rated voltage
Standard models (compliant with Electrical Appliances and Material Safety Act)	2	Single	MY2-02	12, 24, 100/110, 110/120, 200/220, 220/240 VAC
				12, 24, 48, 100/110 VDC
	3	Single	MY3-02	12, 24, 100/110, 110/120, 200/220, 220/240 VAC
				12, 24, 48, 100/110 VDC
	4	Single	MY4-02	12, 24, 100/110, 110/120, 200/220, 220/240 VAC
				12, 24, 48, 100/110 VDC
4	Bifurcated	MY4Z-02	100/110, 110/120, 200/220 VAC	
			12, 24, 48, 100/110 VDC	

●Case-surface mounting

Classification	Number of poles	Contacts	Model	Rated voltage
Standard models (compliant with Electrical Appliances and Material Safety Act)	2	Single	MY2F	24, 100/110, 110/120, 200/220, 220/240 VAC
				12, 24, 48, 100/110 VDC
	3	Single	MY3F	24, 100/110, 200/220 VAC
				24, 100/110 VDC
	4	Single	MY4F	24, 100/110, 110/120, 200/220 VAC
				12, 24, 48, 100/110 VDC
4	Bifurcated	MY4ZF	200/220 VAC	
			12, 24 VDC	

MY

MYK

MYQ-MYH

Common Options (Order Separately)

Common Precautions

Ratings and Specifications

Ratings Operating Coils

Terminal Type	Classification	Number of poles	Contacts	Without operation indicator	With operation indicator
Plug-in terminals	Standard models	2	Single	MY2	MY2N
		4	Single	MY4	MY4N
			Bifurcated	MY4Z	MY4ZN
	Models with built-in diode for coil surge absorption (DC coil specification only)	2	Single	MY2-D	MY2N-D2
		4	Single	MY4-D	MY4N-D2
			Bifurcated	MY4Z-D	MY4ZN-D2
	Models with built-in CR circuit for coil surge absorption (AC coil specification only)	2	Single	MY2-CR	MY2N-CR
		4	Single	MY4-CR	MY4N-CR
	Bifurcated		MY4Z-CR	MY4ZN-CR	

Item	Rated current (mA)		Coil resistance (Ω)	Coil inductance (H)		Must operate voltage (V)	Must release voltage (V)	Maximum voltage (V)	Power consumption (VA, W)	
	Rated voltage (V)	50 Hz		60 Hz	Armature OFF					Armature ON
AC	12	106.5	91	46	0.17	80% max.*1	30% min.*2	110% of rated voltage	Approx. 0.9 to 1.3 (at 60 Hz)	
	24	53.8	46	180	0.69					1.3
	100/110	11.7/12.9	10/11	3,750	14.54					24.6
	110/120	9.9/10.8	8.4/9.2	4,430	19.2					32.1
	200/220	6.2/6.8	5.3/5.8	12,950	54.75					94.07
	220/240	4.8/5.3	4.2/4.6	18,790	83.5	136.4				
DC	12	72.7		165	0.73	80% max.*1	10% min.*2	110% of rated voltage	Approx. 0.9	
	24	36.3		662	3.2					5.72
	48	17.6		2,725	10.6					21.0
	100/110	8.7/9.6		11,440	45.6					86.2

Note: 1. The rated current and coil resistance are measured at a coil temperature of 23°C with tolerances of +15%/-20% for AC rated current and ±15% for DC coil resistance.
 2. The AC coil resistance and inductance values are reference values only (at 60 Hz).
 3. Operating characteristics were measured at a coil temperature of 23°C.
 4. The maximum voltage capacity was measured at an ambient temperature of 23°C.

*1. There is variation between products, but actual values are 80% maximum.
 To ensure operation, apply at least 80% of the rated value (at a coil temperature of 23°C).

*2. There is variation between products, but actual values are 30% minimum for AC and 10% minimum for DC. To ensure release, use a value that is lower than the specified value.

Terminal Type	Classification	Number of poles	Contacts	Without operation indicator	With operation indicator
Plug-in terminals	Standard models	2	Bifurcated	MY2Z	MY2ZN
	Models with built-in diode for coil surge absorption (DC coil specification only)	2	Bifurcated	MY2Z-D	MY2ZN-D2
		3	Single	MY3-D	MY3N-D2
	Models with built-in CR circuit for coil surge absorption (AC coil specification only)	2	Bifurcated	MY2Z-CR	MY2ZN-CR

Item	Rated current (mA)		Coil resistance (Ω)	Coil inductance (H)		Must operate voltage (V)	Must release voltage (V)	Maximum voltage (V)	Power consumption (VA, W)	
	Rated voltage (V)	50 Hz		60 Hz	Armature OFF					Armature ON
AC	12	106.5	91	46	0.17	80% max.*1	30% min.*2	110% of rated voltage	Approx. 0.9 to 1.3 (at 60 Hz)	
	24	53.8	46	180	0.69					1.3
	100/110	11.7/12.9	10/11	3,750	14.54					24.6
	110/120	9.9/10.8	8.4/9.2	4,430	19.2					32.1
	200/220	6.2/6.8	5.3/5.8	12,950	54.75					94.07
	220/240	4.8/5.3	4.2/4.6	18,790	83.5	136.4				
DC	12	75		160	0.73	80% max.*1	10% min.*2	110% of rated voltage	Approx. 0.9	
	24	36.9		650	3.2					5.72
	48	18.5		2,600	10.6					21.0
	100/110	9.1/10		11,000	45.6					86.2

Note: 1. The rated current and coil resistance are measured at a coil temperature of 23°C with tolerances of +15%/-20% for AC rated current and ±15% for DC coil resistance.
 2. The AC coil resistance and inductance values are reference values only (at 60 Hz).
 3. Operating characteristics were measured at a coil temperature of 23°C.
 4. The maximum voltage capacity was measured at an ambient temperature of 23°C.

*1. There is variation between products, but actual values are 80% maximum.
 To ensure operation, apply at least 80% of the rated value.

*2. There is variation between products, but actual values are 30% minimum for AC and 10% minimum for DC. To ensure release, use a value that is lower than the specified value.

Terminal Type	Classification	Number of poles	Contacts	With latching lever
Plug-in terminals	Standard models	2	Single	MY2IN(S)
		4	Single	MY4IN(S)
			Bifurcated	MY4ZIN(S)
		Models with built-in diode for coil surge absorption (DC coil specification only)	2	Single
	4		Single	MY4IN-D2(S)
			Bifurcated	MY4ZIN-D2(S)
	Models with built-in CR circuit for coil surge absorption (AC coil specification only)		2	Single
		4	Bifurcated	MY4ZIN-CR(S)

Rated voltage (V)	Item	Rated current (mA)		Coil resistance (Ω)	Coil inductance (H)		Must operate voltage (V)	Must release voltage (V)	Maximum voltage (V)	Power consumption (VA, W)
		50 Hz	60 Hz		Armature OFF	Armature ON				
AC	100/110	11.7/12.9	10/11	3,750	14.54	24.6	80% max.*1	30% min.*2	110% of rated voltage	Approx. 0.9 to 1.3 (at 60 Hz)
	200/220	6.2/6.8	5.3/5.8	12,950	54.75	94.07				
DC	12	75		160	0.73	1.37		10% min.*2		Approx. 0.9
	24	37.7		636	3.2	5.72				
	48	18.8		2,560	10.6	21				

- Note:** 1. The rated current and coil resistance are measured at a coil temperature of 23°C with tolerances of +15%/-20% for AC rated current and ±15% for DC coil resistance.
 2. The AC coil resistance and inductance values are reference values only (at 60 Hz).
 3. Operating characteristics were measured at a coil temperature of 23°C.
 4. The maximum voltage capacity was measured at an ambient temperature of 23°C.
- *1. There is variation between products, but actual values are 80% maximum. To ensure operation, apply at least 80% of the rated value.
 *2. There is variation between products, but actual values are 30% minimum for AC and 10% minimum for DC. To ensure release, use a value that is lower than the specified value.

Terminal Type	Classification	Number of poles	Contacts	Without operation indicator	With operation indicator
Plug-in terminals	Standard models	3	Single	MY3	MY3N
		4	Crossbar bifurcated	MY4Z-CBG	MY4ZN-CBG
PCB terminals	Standard models	2	Single	MY2-02	—
		3	Single	MY3-02	—
		4	Single	MY4-02	—
			Bifurcated	MY4Z-02	—
Case-surface mounting	Standard models	2	Single	MY2F	—
		3	Single	MY3F	—
		4	Single	MY4F	—
			Bifurcated	MY4ZF	—

Rated voltage (V)	Item	Rated current (mA)		Coil resistance (Ω)	Coil inductance (H)		Must operate voltage (V)	Must release voltage (V)	Maximum voltage (V)	Power consumption (VA, W)
		50 Hz	60 Hz		Armature OFF	Armature ON				
AC	12	106.5	91	46	0.17	0.33	80% max.*1	30% min.*2	110% of rated voltage	Approx. 0.9 to 1.3 (at 60 Hz)
	24	53.8	46	180	0.69	1.3				
	100/110	11.7/12.9	10/11	3,750	14.54	24.6				
	110/120	9.9/10.8	8.4/9.2	4,430	19.2	32.1				
	200/220	6.2/6.8	5.3/5.8	12,950	54.75	94.07				
	220/240	4.8/5.3	4.2/4.6	18,790	83.5	136.4				
DC	12	75		160	0.73	1.37	10% min.*2	Approx. 0.9		
	24	36.9		650	3.2	5.72				
	48	18.5		2,600	10.6	21.0				
	100/110	9.1/10		11,000	45.6	86.2				

- Note:** 1. The rated current and coil resistance are measured at a coil temperature of 23°C with tolerances of +15%/-20% for AC rated current and ±15% for DC coil resistance.
 2. The AC coil resistance and inductance values are reference values only (at 60 Hz).
 3. Operating characteristics were measured at a coil temperature of 23°C.
 4. The maximum voltage capacity was measured at an ambient temperature of 23°C.
- *1. There is variation between products, but actual values are 80% maximum. To ensure operation, apply at least 80% of the rated value.
 *2. There is variation between products, but actual values are 30% minimum for AC and 10% minimum for DC. To ensure release, use a value that is lower than the specified value.

Contact Ratings

Number of poles (contact configuration)	2-pole (DPDT)						3-pole (3PDT)	
	Contact structure				Bifurcated		Single	
	Single		With latching lever (S)					
Load	Resistive load	Inductive load (cos φ = 0.4, L/R = 7 ms)	Resistive load	Inductive load (cos φ = 0.4, L/R = 7 ms)	Resistive load	Inductive load (cos φ = 0.4, L/R = 7 ms)	Resistive load	Inductive load (cos φ = 0.4, L/R = 7 ms)
Rated load	5 A at 220 VAC 5 A at 24 VDC	2 A at 220 VAC 2 A at 24 VDC	5 A at 250 VAC 5 A at 30 VDC	2 A at 250 VAC 2 A at 30 VDC	5 A at 220 VAC 5 A at 24 VDC	2 A at 220 VAC 2 A at 24 VDC	5 A at 220 VAC 5 A at 24 VDC	2 A at 220 VAC 2 A at 24 VDC
Rated carry current*1	5 A (10 A*2)				5 A		5 A	
Maximum switching voltage	250 VAC, 125 VDC						250 VAC, 125 VDC	
Maximum switching current	5 A		10 A		5 A		5 A	
Maximum switching power	1,100 VA 120 W	440 VA 48 W	2,500 VA 300 W	500 VA 60 W	1,100 VA 120 W	440 VA 48 W	1,100 VA 120 W	440 VA 48 W
Contact material	Ag				Au plating + Ag		Ag	

Number of poles (contact configuration)	4-pole (4PDT)									
	Contact structure				Bifurcated				Crossbar bifurcated (CBG)	
	Single		With latching lever (S)				With latching lever (S)			
Load	Resistive load	Inductive load (cos φ = 0.4, L/R = 7 ms)	Resistive load	Inductive load (cos φ = 0.4, L/R = 7 ms)	Resistive load	Inductive load (cos φ = 0.4, L/R = 7 ms)	Resistive load	Inductive load (cos φ = 0.4, L/R = 7 ms)	Resistive load	Inductive load (cos φ = 0.4, L/R = 7 ms)
Rated load	3 A at 220 VAC 3 A at 24 VDC	0.8 A at 220 VAC 1.5 A at 24 VDC	3 A at 250 VAC 3 A at 30 VDC	0.8 A at 250 VAC 1.5 A at 30 VDC	3 A at 220 VAC 3 A at 24 VDC	0.8 A at 220 VAC 1.5 A at 24 VDC	3 A at 250 VAC 3 A at 30 VDC	0.8 A at 250 VAC 1.5 A at 30 VDC	1 A at 220 VAC 1 A at 24 VDC	0.3 A at 220 VAC 0.5 A at 24 VDC
Rated carry current*1	3 A (5 A*2)				3 A (5 A*2)				1 A	
Maximum switching voltage	250 VAC, 125 VDC									
Maximum switching current	3 A (5 A*2)								1 A	
Maximum switching power	660 VA 72 W	176 VA 36 W	1,250 VA 150 W	200 VA 45 W	660 VA 72 W	176 VA 36 W	1,250 VA 150 W	200 VA 45 W	220 VA 24 W	66 VA 12 W
Contact material	Au cladding + Ag alloy (Au plating + Ag*3)								Au cladding + AgPd	

*1. If you use a Socket, do not exceed the rated carry current of the Socket.
 *2. Values shown in parentheses are for the MY□(S) model with latching lever.
 *3. For MY□-02 relays with PCB terminals and MY□F case-surface-mounting relays.

MY

MYK

MYQ-MYH

Common Options (Order Separately)

Common Precautions

Characteristics

Number of poles (contact configuration)	2-pole (DPDT)		3-pole (3PDT)	4-pole (4PDT)			
	Single	Bifurcated	Single	Single	Bifurcated	Crossbar bifurcated (CBG)	
Contact resistance*1 *2	50 mΩ max.					100 mΩ max.	
Operate time*3	20 ms max.						
Release time*3	20 ms max.						
Maximum switching frequency	Mechanical	18,000 operations/h					
	Rated load	1,800 operations/h					
Insulation resistance*4	100 MΩ min.						
Dielectric strength	Between coil and contacts	2,000 VAC, 50/60 Hz for 1 min					
	Between contacts of different polarity						
	Between contacts of the same polarity	1,000 VAC at 50/60 Hz for 1 min	700 VAC at 50/60 Hz for 1 min				
Vibration resistance	Destruction	10 to 55 to 10 Hz, 0.5-mm single amplitude (1.0-mm double amplitude)					
	Malfunction	10 to 55 to 10 Hz, 0.5-mm single amplitude (1.0-mm double amplitude)					
Shock resistance	Destruction	1,000 m/s ²					
	Malfunction	200 m/s ²					
Endurance	Mechanical	AC: 50,000,000 operations min. DC: 100,000,000 operations min. (switching frequency: 18,000 operations/h)	AC: 50,000,000 operations min. DC: 50,000,000 operations min. (switching frequency: 18,000 operations/h)	AC: 50,000,000 operations min. DC: 100,000,000 operations min. (switching frequency: 18,000 operations/h)	AC: 50,000,000 operations min. DC: 100,000,000 operations min. (switching frequency: 18,000 operations/h)	AC: 20,000,000 operations min. DC: 20,000,000 operations min. (switching frequency: 18,000 operations/h)	AC: 50,000,000 operations min. DC: 50,000,000 operations min. (switching frequency: 18,000 operations/h)
	Electrical*5	500,000 operations min. (rated load, switching frequency: 1,800 operations/h)	200,000 operations min. (rated load, switching frequency: 1,800 operations/h)	500,000 operations min. (rated load, switching frequency: 1,800 operations/h)	200,000 operations min. (rated load, switching frequency: 1,800 operations/h)	100,000 operations min. (rated load, switching frequency: 1,800 operations/h)	50,000 operations min. (rated load, switching frequency: 1,800 operations/h)
Failure rate P value (reference value)*6	1 mA at 5 VDC	100 ?A at 1 VDC	1 mA at 5 VDC	1 mA at 1 VDC	100 ?A at 1 VDC	100 ?A at 1 VDC	
Weight	Approx. 35 g	Approx. 35 g	Approx. 35 g	Approx. 35 g	Approx. 35 g	Approx. 35 g	

Note: The data shown above are initial values.

*1. Models with latching lever are 100 mΩ maximum.

*2. Measurement conditions: 1 A at 5 VDC using the voltage drop method.

*3. Measurement conditions: With rated operating power applied, not including contact bounce.

*4. Measurement conditions: For 500 VDC applied to the same location as for dielectric strength measurement.

*5. Ambient temperature condition: 23°C

*6. This value was measured at a switching frequency of 120 operations per minute.

Classification	Standard models					Models with built-in diode for coil surge absorption (-D)/ Models with built-in CR circuit for coil surge absorption (-CR)		
	Single/bifurcated			Crossbar/bifurcated (CBG)		Single/bifurcated		
Contacts				Without operation indicator	With operation indicator			
Features	Without operation indicator	With operation indicator		Without operation indicator	With operation indicator	Without operation indicator	With operation indicator	
		With latching lever					With latching lever	
Ambient operating temperature*1	-55 to 70°C	-55 to 60°C*2	-55 to 70°C	-25 to 70°C	-25 to 60°C	-55 to 60°C*2	-55 to 60°C*2	-55 to 70°C
Ambient operating humidity	5% to 85%					5% to 85%		

*1. With no icing or condensation.

*2. This limitation is due to the diode junction temperature and elements used.

MY

MYK

MYQ-MYH

Common Options (Order Separately)

Common Precautions

Certified Standards

●UL certification (File No. E41515)

Model	Standard number	Category	Listed/ Recognized	Operating Coil ratings	No. of poles	Contact ratings	Certified number of operations
MY2 MY2N MY2IN(S) MY2N-D2 MY2-D2 MY2IN-D2(S) MY2-CR MY2N-CR	UL508	NRNT2	Recognition	6 to 240 VAC 6 to 125 VDC	2	10 A, 250 VAC (General Use) 10 A, 30 VDC (General Use) 7 A, 240 VAC (General Use) 7 A, 24 VDC (Resistive) 5 A, 240 VAC (General Use) 5 A, 250 VAC (Resistive) 5 A, 30 VDC (Resistive) 3 A, 265 VAC (Resistive)	6,000
						1/6 HP, 250 VAC 1/8 HP, 265 VAC 1/10 HP, 120 VAC	1,000
						B300 Pilot Duty (Same polarity)	6,000
MY2Z MY2ZN MY2-02 MY2F MY2Z-D MY2Z-D2 MY2Z-CR MY2ZN-CR	UL508	NRNT2	Recognition	6 to 240 VAC 6 to 125 VDC	2	7 A, 240 VAC (General Use) 7 A, 24 VDC (Resistive) 5 A, 240 VAC (General Use) 5 A, 250 VAC (Resistive) 5 A, 30 VDC (Resistive) 3 A, 265 VAC (Resistive)	6,000
						1/6 HP, 250 VAC 1/8 HP, 265 VAC 1/10 HP, 120 VAC	1,000
						B300 Pilot Duty (Same polarity)	6,000
MY3 MY3N MY3-D MY3N-D2 MY3-02 MY3F	UL508	NRNT2	Recognition	6 to 240 VAC 6 to 125 VDC	3	5 A, 28 VDC (Resistive) 5 A, 240 VAC (General Use)	6,000
						1/6 HP, 250 VAC	1,000
MY4 MY4N MY4IN(S) MY4-D MY4N-D2 MY4IN-D2(S) MY4Z MY4ZN MY4ZIN(S) MY4Z-D MY4ZN-D2 MY4ZIN-D2(S) MY4Z-CR MY4ZN-CR MY4ZIN-CR(S) MY4-02 MY4F MY4Z-02 MY4ZF	UL508	NRNT2	Recognition	6 to 240 VAC 6 to 125 VDC	4	5 A, 28 VDC (General Use) (Same polarity) 5 A, 240 VAC (General Use) (Same polarity) 5 A, 30 VDC (Resistive) (Same polarity) 5 A, 250 VAC (Resistive) (Same polarity) 0.2 A, 120 VDC (Resistive) (Same polarity)	6,000
						1/6 HP, 250 VAC (Same polarity) 1/10 HP, 120 VAC (Same polarity)	1,000
						B300 Pilot Duty (Same polarity)	6,000

MY

MYK

MYQ-MYH

Common Options (Order Separately)

Common Precautions

●CSA certification (File No. LR31928)

Model	Standard number	Class number	Operating Coil ratings	No. of poles	Contact ratings	Certified number of operations	
MY2 MY2N MY2IN(S) MY2N-D2 MY2-D2 MY2IN-D2(S) MY2-CR MY2N-CR	C22.2 No.0, No.14	3211 07	6 to 240 VAC 6 to 125 VDC	2	7 A, 240 VAC (Resistive) 7 A, 24 VDC (Resistive) 5 A, 240 VAC (General Use) 5 A, 250 VAC (Resistive) 5 A, 30 VDC (Resistive)	6,000	
						1/6 HP, 250 VAC (Same polarity) 1/10 HP, 120 VAC (Same polarity)	1,000
MY2Z MY2ZN MY2-02 MY2F MY2Z-D MY2Z-D2 MY2Z-CR MY2ZN-CR	C22.2 No.0, No.14		6 to 240 VAC 6 to 125 VDC	2	7 A, 240 VAC (General Use) (Same polarity) 7 A, 24 VDC (Resistive) (Same polarity) 5 A, 240 VAC (General Use) (Same polarity) 5 A, 30 VDC (Resistive) 5 A, 250 VAC (Resistive) (Same polarity) 0.2 A, 120 VDC (Resistive)	6,000	
						1/6 HP, 250 VAC 1/10 HP, 120 VAC	1,000
MY3 MY3N MY3-D MY3N-D2 MY3-02 MY3F	C22.2 No.0, No.14		6 to 240 VAC 6 to 125 VDC	3	5 A, 28 VDC (Resistive) 5 A, 240 VAC (General Use) 7 A, 240 VAC (General Use) 7 A, 24 VDC (Resistive)	6,000	
						1/6 HP, 250 VAC	1,000
MY4 MY4N MY4N(S) MY4-D MY4N-D2 MY4IN-D2(S) MY4-CR MY4N-CR MY4IN-CR(S) MY4Z MY4ZN MY4ZIN(S) MY4Z-D MY4ZN-D2 MY4ZIN-D2(S) MY4Z-C MY4ZN-CR MY4ZIN-CR(S)	C22.2 No.14	3211 07	6 to 240 VAC 6 to 125 VDC	4	5 A, 240 VAC (General Use) (Same polarity) 5 A, 28 VDC (General Use) (Same polarity) 5 A, 250 VAC (Resistive) (Same polarity) 5 A, 30 VDC (Resistive) (Same polarity) 0.2 A, 120 VDC (Resistive) (Same polarity)	6,000	
					1/6 HP, 250 VAC (Same polarity) 1/10 HP, 120 VAC (Same polarity)	1,000	
					B300 Pilot Duty (Same polarity)	6,000	
MY4-02 MY4F MY4Z-02 MY4ZF	C22.2 No.0, No.14	3211 07	6 to 240 VAC 6 to 125 VDC	4	7 A, 240 VAC (General Use) (Same polarity) 7 A, 24 VDC (Resistive) (Same polarity) 5 A, 240 VAC (General Use) (Same polarity) 5 A, 30 VDC (Resistive) 5 A, 250 VAC (Resistive) (Same polarity) 0.2 A, 120 VDC (Resistive)	6,000	
					1/6 HP, 250 VAC 1/10 HP, 120 VAC	1,000	

●TÜV Rheinland certification (Certification No. R50030059)

Model	Operating Coil ratings	Contact ratings	Certified number of operations
MY2Z MY2ZN MY2-02 MY2F MY2Z-D MY2Z-D2 MY2Z-CR MY2ZN-CR	6 to 125 VDC, 6 to 240 VAC	5 A, 250 VAC (cos φ = 1.0)	100,000
MY3 MY3N MY3-D MY3N-D2 MY3-02 MY3F		5 A, 250 VAC (cos φ = 1.0) 0.8 A, 250 VAC (cos φ = 0.4)	
MY4-02 MY4F MY4Z-02 MY4ZF		3 A, 120 VAC (cos φ = 1.0) 0.8 A, 250 VAC (cos φ = 0.4)	

MY

MYK

MYQ-MYH

Common Options (Order Separately)

Common Precautions

●CE Marking

Model	EMC Directive	Low Voltage Directive	Machinery Directive	Safety Category
MY2 MY2N MY2IN(S) MY2Z MY2ZN MY2-D MY2N-D2 MY2IN-D2(S) MY2-CR MY2N-CR MY2Z-CR MY2ZN-CR MY2Z-D MY2ZN-D2 MY2F <hr/> MY3 MY3N MY3-D MY3N-D2 MY3F <hr/> MY4 MY4N MY4IN(S) MY4Z MY4ZN MY4ZIN(S) MY4-D MY4N-D2 MY4IN-D2(S) MY4Z-D MY4ZN-D2 MY4ZIN-D2(S) MY4-CR MY4N-CR MY4Z-CR MY4ZN-CR MY4F MY4ZF	Not applicable	Applicable	Not applicable	1

●LR certification (Lloyd's Register)

Model	File No.	Environmental Category	Operating Coil ratings	Contact ratings	Certified number of operations
MY2 MY2N MY2IN(S) MY2-D MY2N-D2 MY2IN-D2(S) MY2-CR MY2N-CR	File No.98/10014	ENV2,3	6 to 240 VAC 6 to 125 VDC	10 A, 250 VAC (Resistive) 2 A, 250 VAC (PF0.4) 10 A, 30 VDC (Resistive) 2 A, 30 VDC (L/R = 7 ms)	MY2: 50,000
MY2Z MY2ZN MY2Z-D MY2ZN-D2	File No.90/10270	ENV2,3	6 to 240 VAC 6 to 125 VDC	2 A, 30 VDC inductive load 2 A, 200 VAC inductive load	MY2: 50,000
MY4 MY4N MY4IN(S) MY4-D MY4N-D2 MY4IN-D2(S) MY4-CR MY4N-CR MY4IN-CR(S) MY4Z MY4ZN MY4ZIN(S) MY4Z-D MY4ZN-D2 MY4ZIN-D2(S) MY4Z-CR MY4ZN-CR MY4ZIN-CR(S)	File No.98/10014	ENV2,3	6 to 240 VAC 6 to 125 VDC	5 A, 250 VAC (Resistive) 0.8 A, 250 VAC (PF0.4) 5 A, 30 VDC (Resistive) 1.5 A, 30 VDC (L/R = 7 ms)	MY4: 50,000

MY

MYK

MYQ-MYH

Common Options (Order Separately)

Common Precautions

●VDE certification

Model	Standard number	Certification No.	Operating Coil ratings	Contact ratings	Certified number of operations
MY2 MY2N MY2IN(S) MY2-D MY2N-D2 MY2IN-D2(S) MY2-CR MY2N-CR	EN 61810-1	112467UG	6, 12, 24, 48/50, 100/110, 110/120, 200/220, 220/240 VAC	10A, 250 VAC (cos φ = 1) 10A, 30 VDC (L/R = 0 ms)	MY2: 100,000 MY4: 100,000 MY4Z: 50,000 (AC)
MY4 MY4N MY4IN(S) MY4Z MY4ZN MY4ZIN(S) MY4-D MY4ZN-D2 MY4IN-D2(S) MY4Z-D MY4Z-D2 MY4ZIN-D2(S) MY4-CR MY4N-CR MY4IN-CR(S) MY4Z-CR MY4ZN-CR MY4ZIN-CR(S)			6, 12, 24, 48/50, 100/110, 110/120, 200/220, 220/240 VAC	5 A, 250 VAC (cos φ = 1) 5 A, 30 VDC (L/R = 0 ms)	

MY

MYK

MYQ-MYH

Common Options (Order Separately)

Common Precautions

● Maximum Switching Capacity

MY2 and MY3

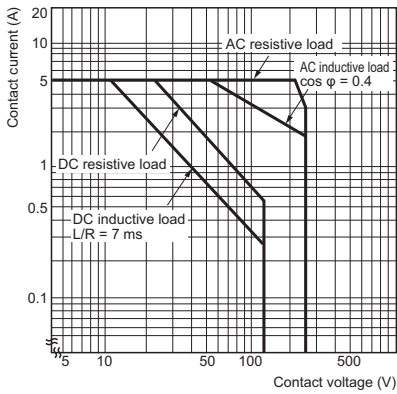

MY4 and MY4Z

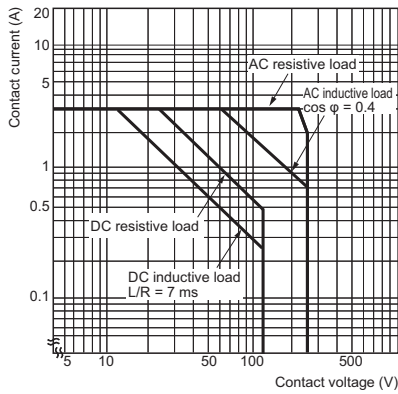

MY4Z-CBG

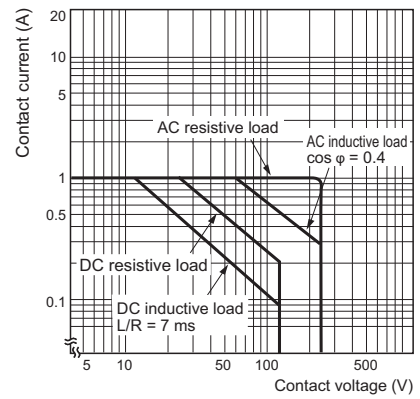

With latching lever

MY2(S)

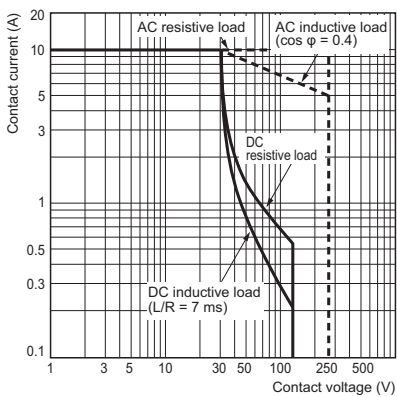

MY4(S) and MY4Z(S)

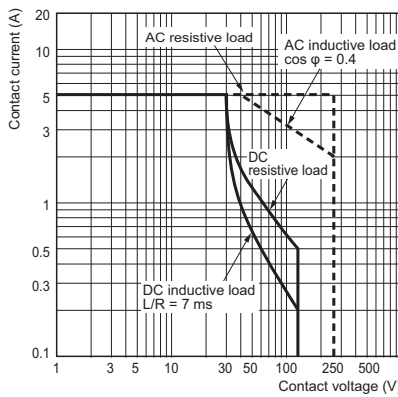

● Endurance Curve

MY2 and MY3

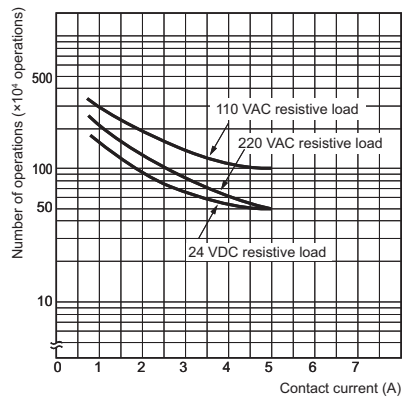

MY2 and MY3

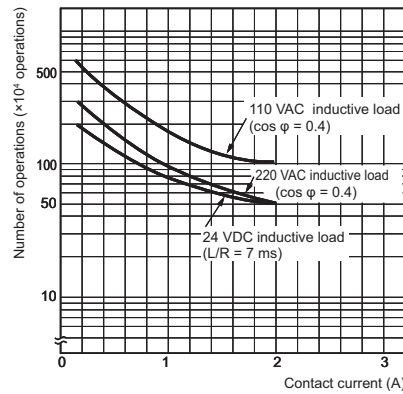

MY4

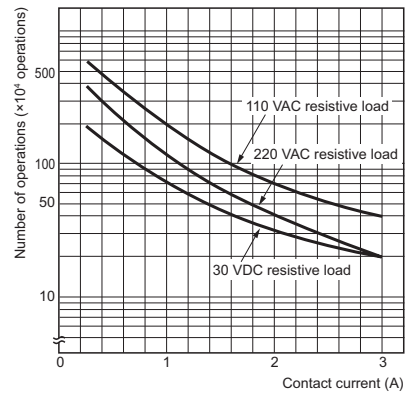

MY4

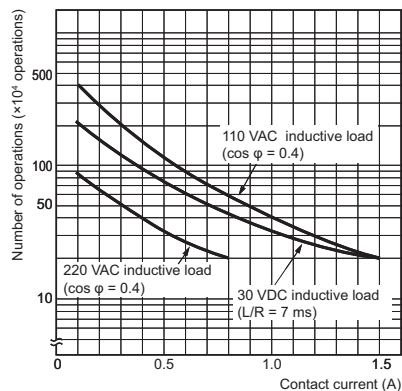

MY4Z

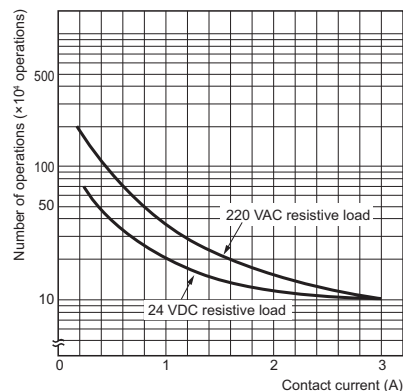

MY4Z

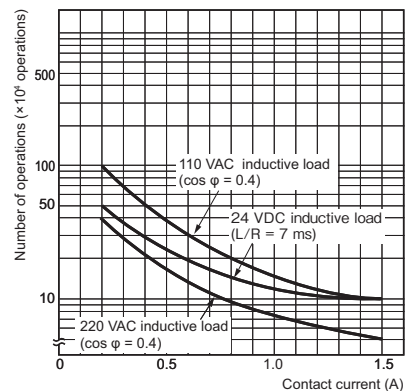

MY

MYK

MYQ-MYH

Common Options (Order Separately)

Common Precautions

With latching lever

MY2(S)

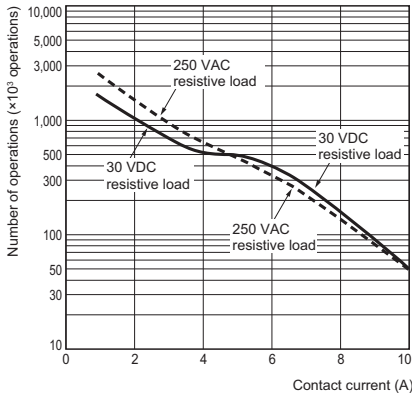

MY2(S)

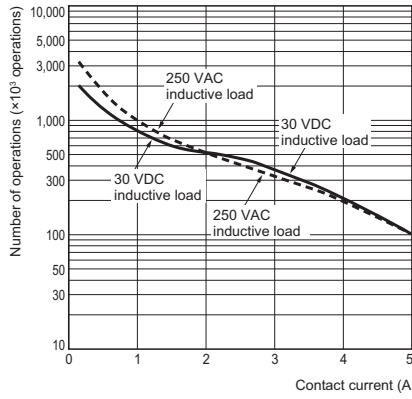

MY4(S)

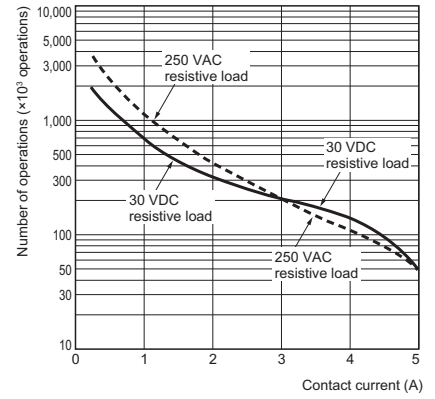

MY4(S)

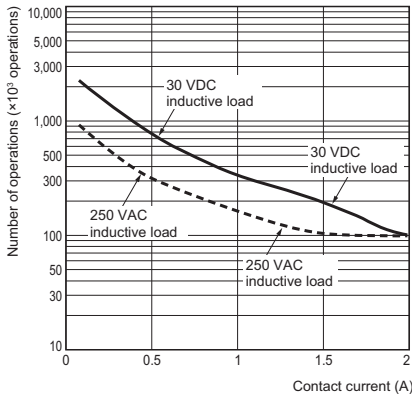

MY4Z(S)

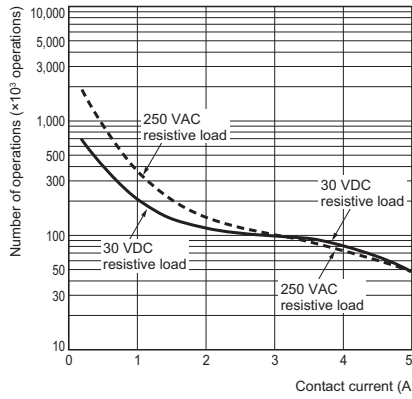

MY4Z(S)

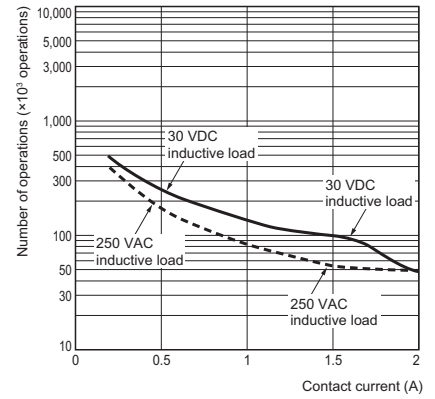

● Ambient Temperature vs. Must-operate and Must-release Voltage

MY2 AC Models

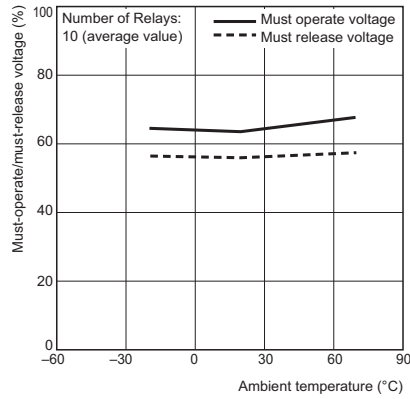

MY2 DC Models

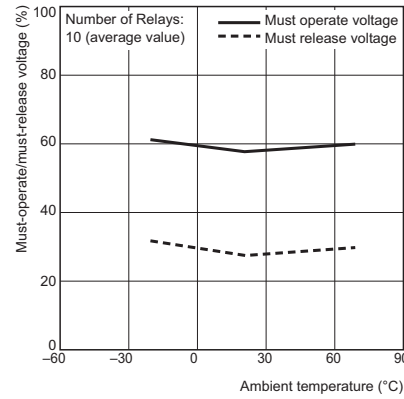

MY4 AC Models

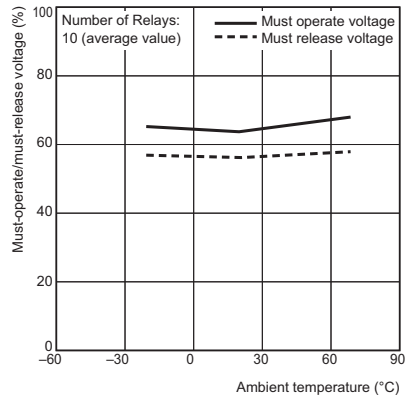

MY4 DC Models

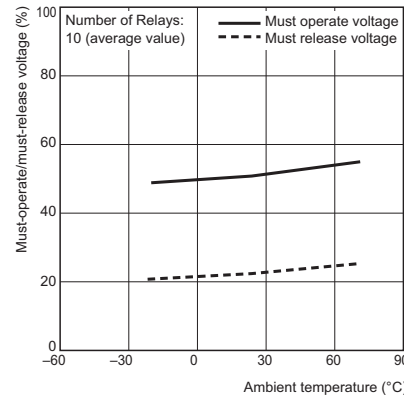

MY

MYK

MYQ-MYH

Common Options (Order Separately)

Common Precautions

● Ambient Temperature vs. Coil Temperature Rise

MY2 AC Models, 50 Hz

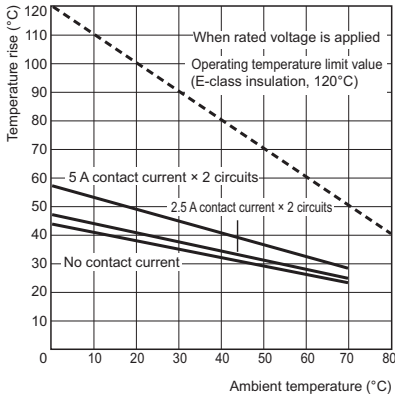

MY2 DC Models

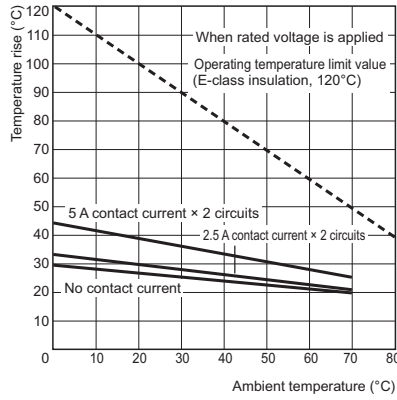

MY4 AC Models, 50 Hz

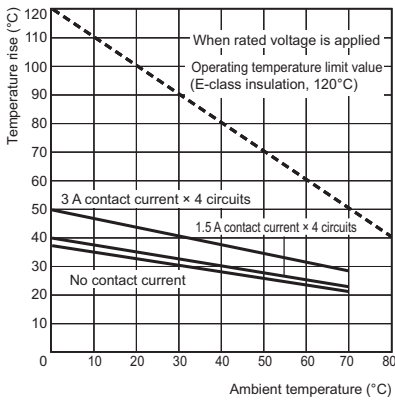

MY4 DC Models

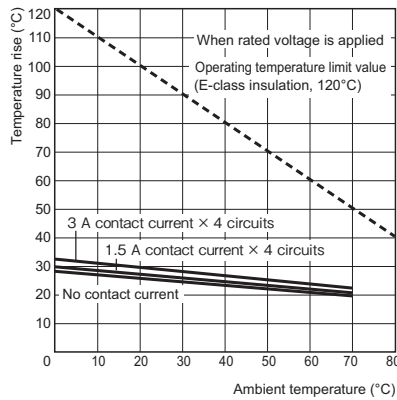

Models with built-in diode for coil surge absorption MY□-D

With Diode

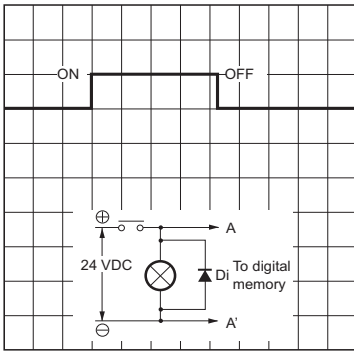

Without Diode

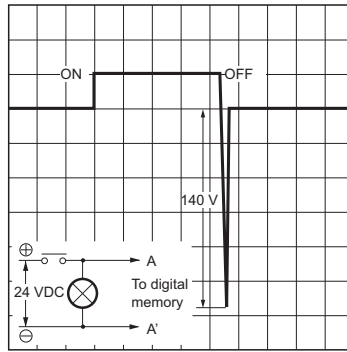

- Note:
1. Make sure that the polarity is correct.
 2. The release time will increase, but the 20-ms specification for standard models is satisfied.
 3. Diode properties: The diode has a reversed dielectric strength of 1,000 V.
Forward current: 1 A

Models with built-in CR circuit for coil surge absorption MY□-CR

With CR

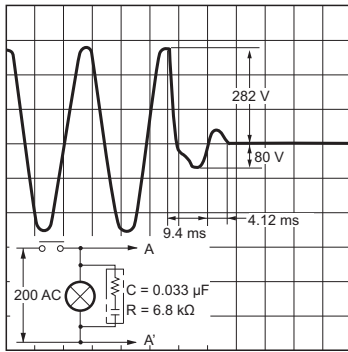

Without CR

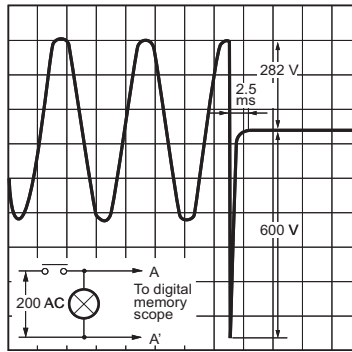

● Contact Reliability Test MY4Z-CBG (Modified Allen Bradley Circuit)

Contact load: 5 VDC, 1 mA resistive load

Malfunction level: Contact resistance of 100 Ω

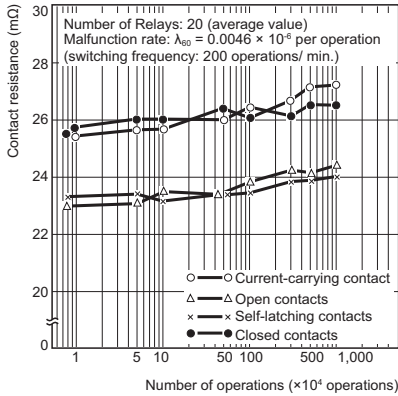

Common Specifications for MY2, MY3, MY4, MY4Z, MY□-02, MY□F, and MY(S)

● Shock Malfunction

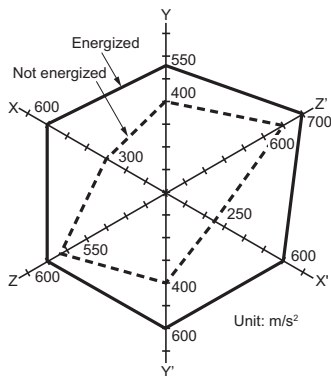

N = 20

Measurement: Shock was applied 3 times each in 6 directions along 3 axes with the Relay energized and not energized to check the shock values that cause the Relay to malfunction.

Criteria: Non-energized: 200 m/s²,
Energized: 200 m/s²

Shock direction

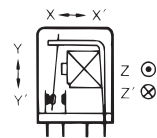

MY

MYK

MYQ-MYH

Common Options (Order Separately)

Common Precautions

Dimensions

(Unit: mm)

● Plug-in terminals

MY2, MY2N, MY2-D and MY2N-D2
MY2-CR, MY2N-CR

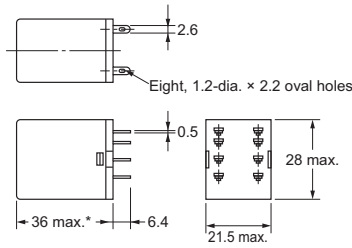
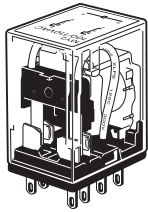

* For the MY2-CR 24 VAC and MY2N-CR 24 VAC, this dimension is 53 mm maximum.

Terminal Arrangement/
Internal Connection Diagram
(Bottom View)

MY2
(AC/DC Models)

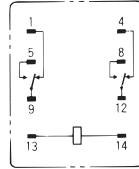

(Coil has no polarity)

MY2N

DC Models

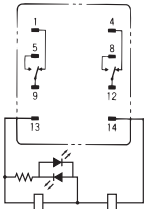

(Coil has no polarity)

AC Models

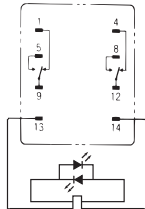

(Coil has no polarity)

MY2-D

(DC Models Only)

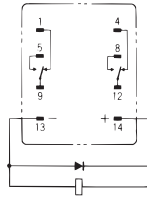

(Coil has polarity)

MY2N-D2

(DC Models Only)

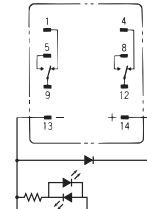

(Coil has polarity)

MY2-CR

(AC Models Only)

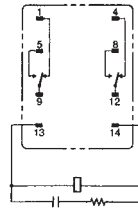

(Coil has no polarity)

MY2N-CR

(AC Models Only)

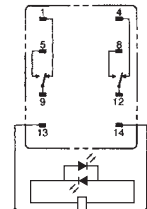

(Coil has no polarity)

- Note:
1. An AC model has coil disconnection self-diagnosis.
 2. For the DC models, check the coil polarity when wiring and wire all connections correctly.
 3. The indicator is red for AC and green for DC.
 4. The operation indicator indicates the energization of the coil and does not represent contact operation.

MY2Z, MY2ZN, MY2Z-D and MY2ZN-D2
MY2Z-CR, MY2ZN-CR

Terminal Arrangement/Internal
Connection Diagram
(Bottom View)

MY2Z
(AC/DC Models)

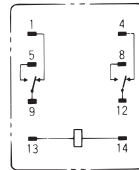

(Coil has no polarity)

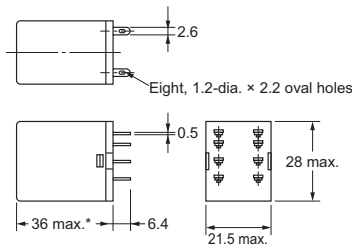
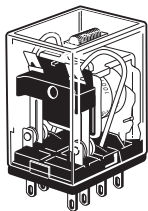

* For the MY2Z-CR and MY2ZN-CR, this dimension is 53 mm maximum.

MY2ZN

DC Models

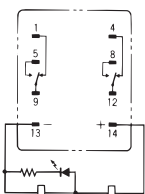

(Coil has polarity)

AC Models

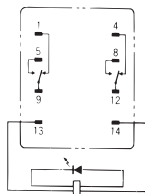

(Coil has no polarity)

MY2Z-D

(DC Models Only)

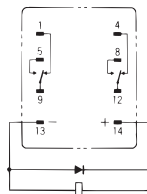

(Coil has polarity)

MY2ZN-D2

(DC Models Only)

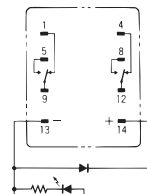

(Coil has polarity)

MY2Z-CR

(AC Models Only)

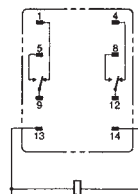

(Coil has no polarity)

MY2ZN-CR

(AC Models Only)

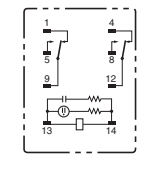

(Coil has no polarity)

- Note:
1. An AC model has coil disconnection self-diagnosis.
 2. For the DC models, check the coil polarity when wiring and wire all connections correctly.
 3. The indicator is red for AC and green for DC.
 4. The operation indicator indicates the energization of the coil and does not represent contact operation.

MY3, MY3N, MY3-D, and MY3N-D2

Terminal Arrangement/
Internal Connection Diagram
(Bottom View)

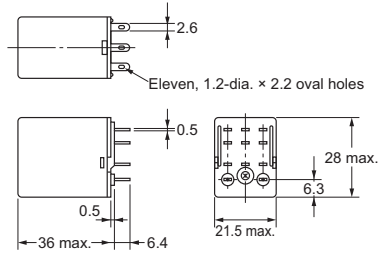
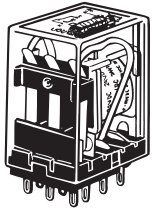

MY3
(AC/DC Models)

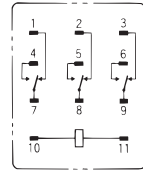

(Coil has no polarity)

MY3N

DC Models

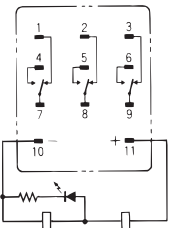

(Coil has polarity)

AC Models

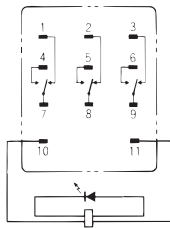

(Coil has no polarity)

MY3-D

(DC Models Only)

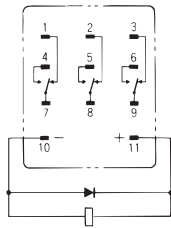

(Coil has polarity)

MY3N-D2

(DC Models Only)

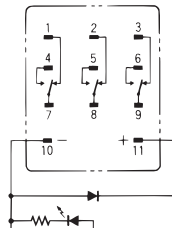

(Coil has polarity)

- Note:**
1. An AC model has coil disconnection self-diagnosis.
 2. For the DC models, check the coil polarity when wiring and wire all connections correctly.
 3. The indicator is red for AC and green for DC.
 4. The operation indicator indicates the energization of the coil and does not represent contact operation.

MY4, MY4N, MY4-D and MY4N-D2

MY4-CR, MY4N-CR

Terminal Arrangement/
Internal Connection Diagram
(Bottom View)

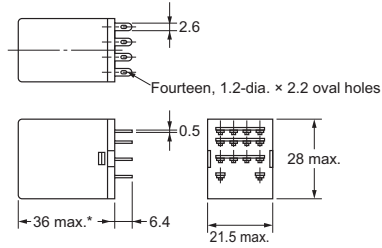
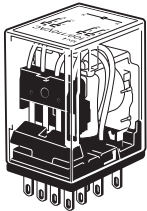

MY4
(AC/DC Models)

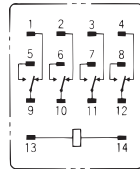

(Coil has no polarity)

* For the MY4-CR 24 VAC and MY4N-CR 24 VAC/115 VAC, this dimension is 53 mm maximum.

MY4N

DC Models

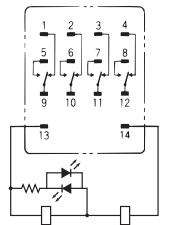

(Coil has no polarity)

AC Models

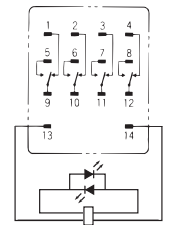

(Coil has no polarity)

MY4-D

(DC Models Only)

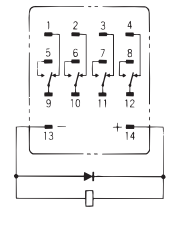

(Coil has polarity)

MY4N-D2

(DC Models Only)

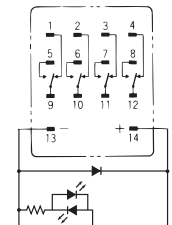

(Coil has polarity)

MY4-CR

(AC Models Only)

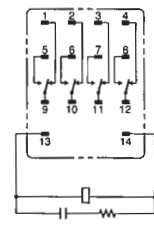

(Coil has no polarity)

MY4N-CR

(AC Models Only)

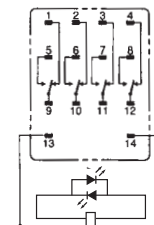

(Coil has no polarity)

- Note:**
1. An AC model has coil disconnection self-diagnosis.
 2. For the DC models, check the coil polarity when wiring and wire all connections correctly.
 3. The indicator is red for AC and green for DC.
 4. The operation indicator indicates the energization of the coil and does not represent contact operation.

MY4Z, MY4ZN, MY4Z-D, MY4ZN-D2
MY4Z-CR, MY4ZN-CR

MY

Terminal Arrangement/Internal Connection Diagram (Bottom View)

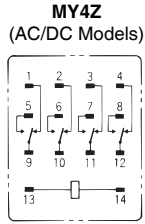
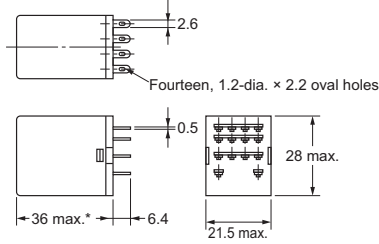
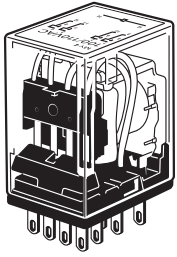

(Coil has no polarity)

MY4ZN

DC Models

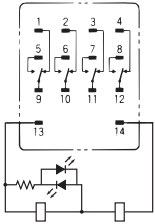

(Coil has no polarity)

AC Models

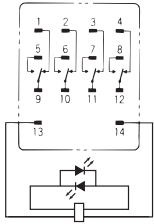

(Coil has no polarity)

MY4Z-D

(DC Models Only)

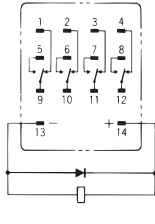

(Coil has polarity)

MY4ZN-D2

(DC Models Only)

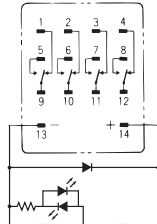

(Coil has polarity)

MY4Z-CR

(AC Models Only)

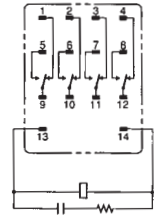

(Coil has no polarity)

MY4ZN-CR

(AC Models Only)

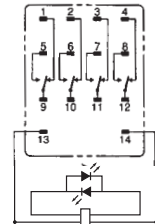

(Coil has no polarity)

- Note:**
1. An AC model has coil disconnection self-diagnosis.
 2. For the DC models, check the coil polarity when wiring and wire all connections correctly.
 3. The indicator is red for AC and green for DC.
 4. The operation indicator indicates the energization of the coil and does not represent contact operation.

MYK

MYQ-MYH

MY2IN(S)
MY2IN-D2(S)

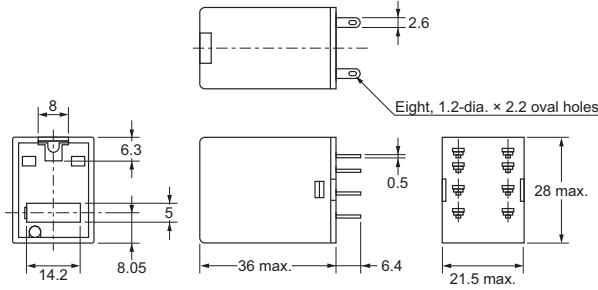
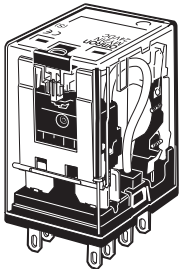

Terminal Arrangement/Internal Connections (Bottom View)

MY2IN(S)
(AC Models)

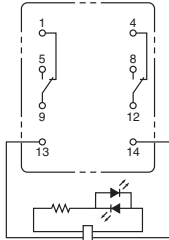

MY2IN(S)
(DC Models)

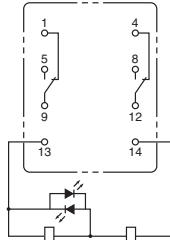

MY2IN-D2(S)
(DC Models Only)

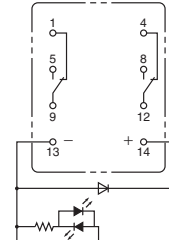

Note: For the DC models, check the coil polarity when wiring and wire all connections correctly.

Common Options (Order Separately)

Common Precautions

MY(Z)IN(S)
MY4(Z)IN-D2(S)
MY4(Z)IN-CR(S)

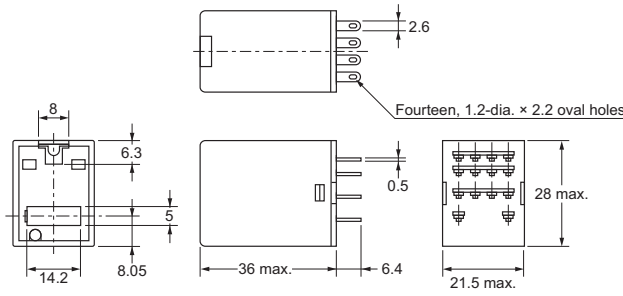
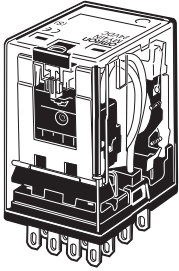

Terminal Arrangement/Internal Connections (Bottom View)

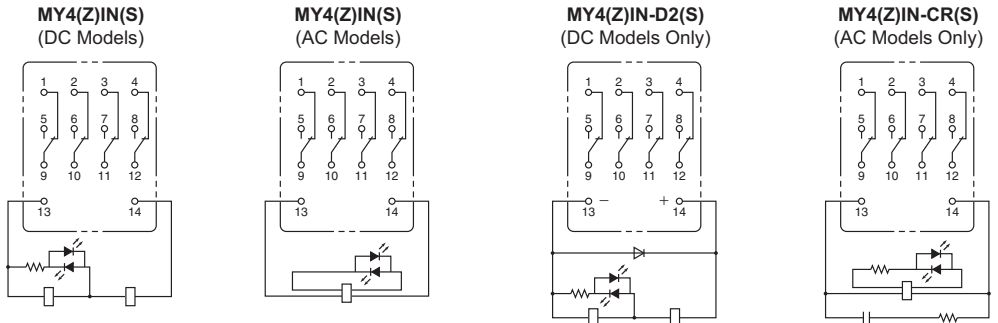

Note: For the DC models, check the coil polarity when wiring and wire all connections correctly.

MY4Z-CBG
MY4ZN-CBG

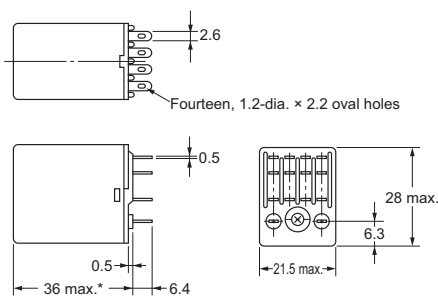
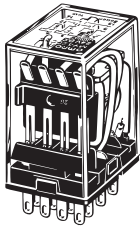

Terminal Arrangement/Internal Connection Diagram (Bottom View)

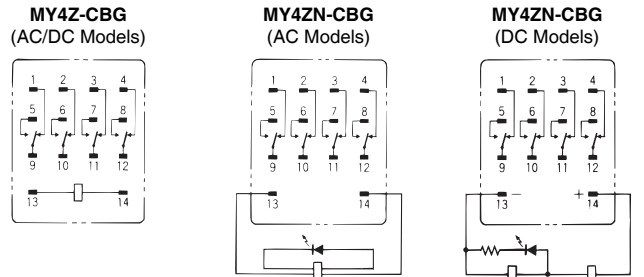

* For the MY4ZN-CBG-CR, this dimension is 53 mm max.

(The coil has no polarity.) (The coil has no polarity.) (The coil has polarity.)

● PCB terminals

MY2-02
MY3-02
MY4-02
MY4Z-02

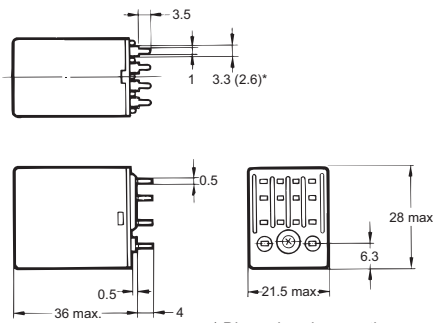

PCB Processing Dimensions (Bottom View)

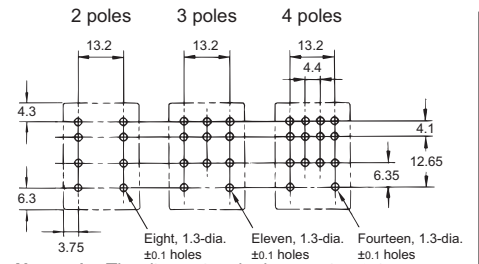

The figure and outline drawing show MY4-02. The 2-pole and 3-pole models conform to these dimensions.

* Dimensions in parentheses are for the MY4-02.

Note: 1. The dimensional tolerance is ± 0.1 .
2. Refer to the terminal arrangement and internal connections diagrams for the MY2, MY3, MY4, and MY4Z.

● Case-surface mounting

MY2F
MY3F
MY4F
MY4ZF

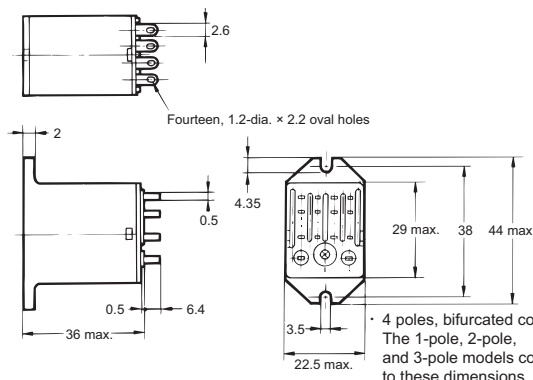

Mounting Hole Dimensions

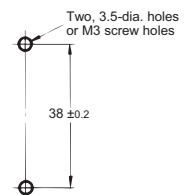

The above figure is for the MY4F. The 2-pole and 3-pole models conform to these dimensions.

4 poles, bifurcated contacts
The 1-pole, 2-pole, and 3-pole models conform to these dimensions.

Note: Refer to the terminal arrangement and internal connections diagrams for the MY2, MY3, MY4, and MY4Z.

MY

Latching miniature power relays that retain contact operation status

- A low power consumption type that retains contacts using a magnetic lock system.
- Equipped with mechanical operation indicators to make operation status easy-to-see.

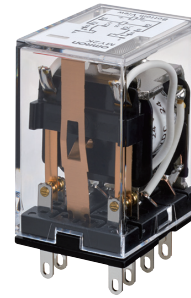

⚠ Refer to *Safety Precautions* on pages 54 to 55 and *Safety Precautions for All Relays*.

MYK

Features

Latching Relays MYK

Retains contact operation status.

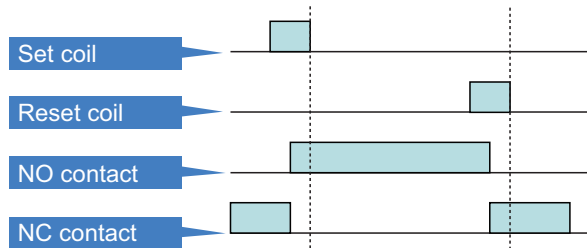

NO contact turns on when voltage is applied to the set coil and stays on even if voltage stops being applied to the set coil. NO contact turns off when voltage is applied to the reset coil, after which NC contact will turn on.*

*MYK features a magnetic lock system.

Contact operation status can be seen at a glance thanks to the mechanical operation indicator.

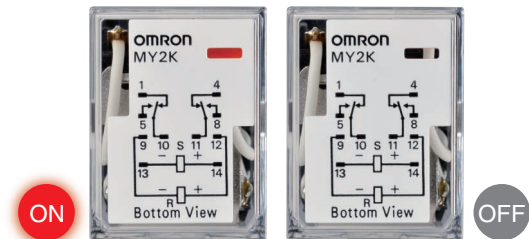

MYQ-MYH

Common Options (Order Separately)

Common Precautions

Model Number Structure

Model Number Legend

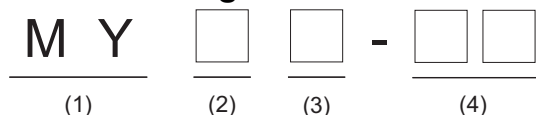

(1) Basic model name

MY: Miniature Power Relays

(3) Type

K: Latching relay

(2) Number of poles/contacts

2: 2-pole, single

(4) Options, terminal type

None: Plug-in terminals

02: PCB terminals

Ordering Information

When your order, specify the rated voltage.

Main unit

● Plug-in terminals

Classification	Number of poles	Contacts	Model	Rated voltage
Standard models (compliant with Electrical Appliances and Material Safety Act)	2	Single	MY2K	12, 24, 100, 100/110 VAC
				12, 24, 48 VDC

● PCB terminals

Classification	Number of poles	Contacts	Model	Rated voltage
Standard models (compliant with Electrical Appliances and Material Safety Act)	2	Single	MY2K-02	24, 100 VAC
				12, 24 VDC

MY

MYK

MYQ-MYH

Common Options (Order Separately)

Common Precautions

Ratings and Specifications

Ratings

● Operating coil

Rated voltage (V)	Set coil			Reset coil			Must operate voltage (V)	Must release voltage (V)	Maximum voltage (V)	Power consumption (VA, W)	
	Rated current (mA)		Coil resistance (Ω)	Rated current (mA)		Coil resistance (Ω)				Set coil	Reset coil
	50 Hz	60 Hz		50 Hz	60 Hz						
AC	12	57	56	72	39	38.2	80% max.*	80% max.	110% max. of rated voltage	Approx. 0.6 to 0.9 (at 60 Hz)	Approx. 0.2 to 0.5 (at 60 Hz)
	24	27.4	26.4	320	18.6	18.1					
	100	7.1	6.9	5,400	3.5	3.4					
DC	12	110		110	50		80% max.*	80% max.	110% max. of rated voltage	Approx. 1.3	Approx. 0.6
	24	52		470	25						
	48	27		1,800	16						

- Note:**
- The rated current for AC is the value measured with a DC ammeter in half-wave rectification.
 - The rated current and coil resistance are measured at a coil temperature of 23°C with tolerances of +15%/-20% for AC rated current and ±15% for DC coil resistance.
 - The AC coil resistance is a reference value only.
 - Operating characteristics were measured at a coil temperature of 23°C.
 - The maximum voltage capacity was measured at an ambient temperature of 23°C.
- *There is variation between products, but actual values are 80% maximum.

● Contact Ratings

Number of poles (contact configuration) Contact structure	2-pole (DPDT)	
	Single	
	Resistive load	Inductive load (cos φ = 0.4, L/R = 7 ms)
Rated load	3 A at 220 VAC 3 A at 24 VDC	0.8 A at 220 VAC 1.5 A at 24 VDC
Rated carry current	3 A	
Maximum switching voltage	250 VAC, 125 VDC	
Maximum switching current	3 A	
Maximum switching power	660 VA 72 W	176 VA 36 W
Contact material	Au plating + Ag	

Characteristics

Contact resistance*1	50 mΩ max.	
Set	Operate time*2	AC: 30 ms max., DC: 15 ms max.
	Minimum pulse width	AC: 60 ms, DC: 30 ms
Reset	Release time*2	AC: 30 ms max., DC: 15 ms max.
	Minimum pulse width	AC: 60 ms, DC: 30 ms
Maximum switching frequency	Mechanical	18,000 operations/h
	Rated load	1,800 operations/h
Insulation resistance*3	100 MΩ min.	
Dielectric strength	Between coil and contacts Between contacts of different polarity	1,500 VAC at 50/60 Hz for 1 min
	Between contacts of the same polarity	1,000 VAC at 50/60 Hz for 1 min
	Between set/reset coils	
Vibration resistance	Destruction	10 to 55 to 10 Hz, 0.5-mm single amplitude (1.0-mm double amplitude)
	Malfunction	10 to 55 to 10 Hz, 0.5-mm single amplitude (1.0-mm double amplitude)
Shock resistance	Destruction	1,000 m/s ²
	Malfunction	200 m/s ²
Endurance	Mechanical	100,000,000 operations min. (switching frequency: 18,000 operations/h)
	Electrical*4	200,000 operations min. (at rated load, switching frequency: 1,800 operations/h)
Failure rate P value (reference value)*5	1 mA at 1 VDC	
Ambient operating temperature*6	-55 to 60°C	
Ambient operating humidity	5% to 85%	
Weight	Approx. 30 g	

- Note:** The data shown above are initial values.
- Measurement conditions: 1 A at 5 VDC using the voltage drop method.
 - Measurement conditions: With rated operating power applied, not including contact bounce.
 - Measurement conditions: For 500 VDC applied to the same location as for dielectric strength measurement.
 - Ambient temperature condition: 23°C
 - This value was measured at a switching frequency of 120 operations per minute.
 - With no icing or condensation.

Engineering Data (Reference Value)

Maximum Switching Capacity MY2K(-02)

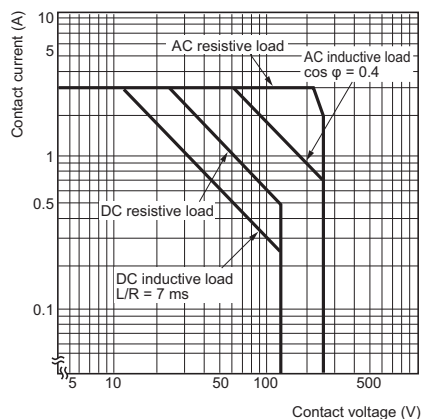

Endurance Curve MY2K(-02)

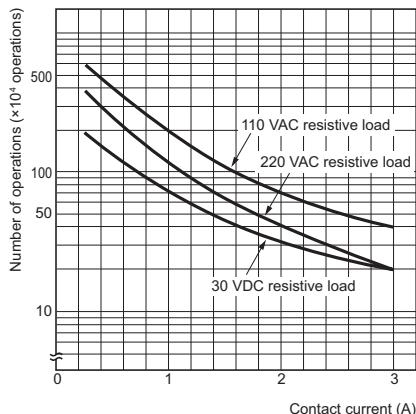

MY2K(-02)

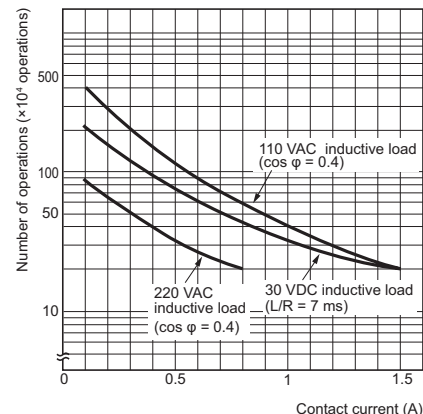

Magnetic Interference (External Magnetic Field) MY2K 24 VDC

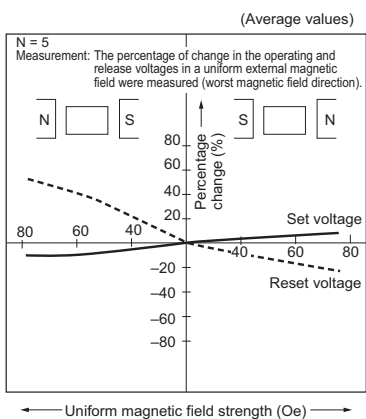

Latching Deterioration Over Time MY2K 24 VDC

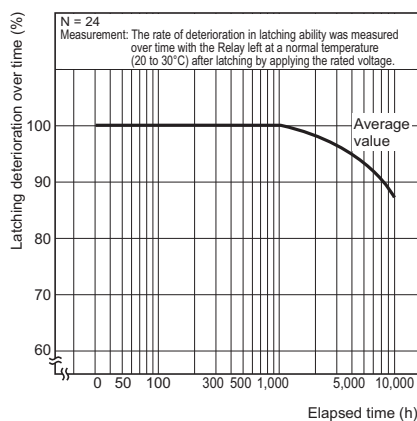

Shock Malfunction MY2K 100 VAC

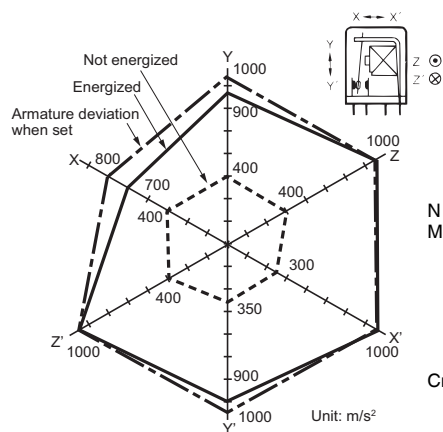

N = 20
Measurement: Shock was applied in 6 directions along 3 axes 2 times with the Relay energized and 3 times with the Relay not energized to check the shock values that cause the Relay to malfunction.
Criteria: Non-energized: 200 m/s²
Energized: 200 m/s²

MY

MYK

MYQ-MYH

Common Options (Order Separately)

Common Precautions

Dimensions

(Unit: mm)

● Plug-in terminals
MY2K

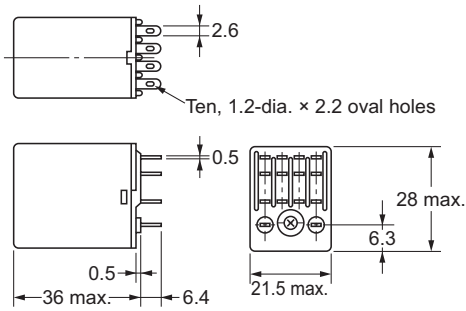
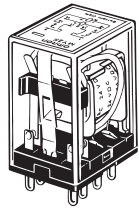

Terminal Arrangement/
Internal Connection Diagram
(Bottom View)

For AC

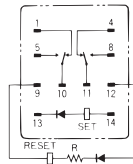

Note: R is a resistor for ampere-tur correction. Built into models with specifications of 50 VAC or more. (The coil has no polarity.)

For DC

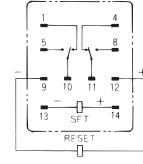

Note: Pay close attention to the set coil and reset coil polarities. If the connections are not correct, unintended operation may occur.

● PCB terminals
MY2K-02

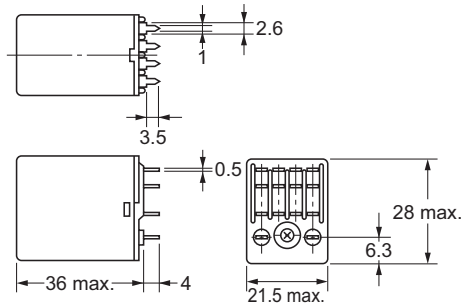
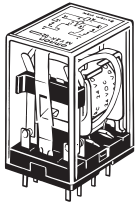

PCB Processing Dimensions
(Bottom View)

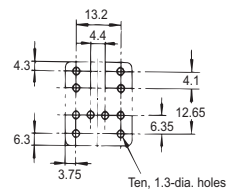

Note: The dimensional tolerance is ± 0.1 .

MY

MYK

MYQ-MYH

Common Options (Order Separately)

Common Precautions

MYQ/MYH

Sealed relays that are tough in environments where dust or corrosive gases, etc., are present

- Plastic sealed relays (MYQ) and hermetically sealed relays (MYH) that are resistant to effects from the surrounding environment
- Highly airtight structures that are tough in environments where corrosive gases such as chloride gas, sulfuric gas, and silicone gas are generated. They are also resistant to environments where salt damage is occurred and where dust is generated.
- Prevent relay contact failures via a highly airtight structure.

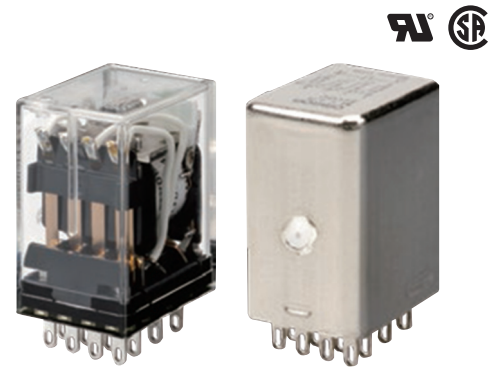

 Refer to *Safety Precautions* on pages 54 to 55 and *Safety Precautions for All Relays*.



Refer to the standards certifications and compliance section of your OMRON website for the latest information on certified models.

Features

Highly Airtight Relays (Plug-in Terminals)

Seal performance	Degree of protection	Typical relay	Features
High ↑ Low	 Hermetically sealed	MYH	Sealing with metals, the glass case and base, etc. with inert gases (N ₂) inside makes it airtight structure which provides the external casing with durability against harmful corrosion, and prevents corrosive gases from intruding inside relays.
	 Plastic sealed	MYQ	Structure that seals relays with the resin case and cover, etc., to prevent effects from corrosive environments.
	 Closed type (cased)	MY, MY4Z-CBG	Relays in the case realize the structure that protects them from contact with foreign materials.

Plastic Sealed Relays: MYQ

These realize excellent reliability even in environments where salt damage occurs or where dust is generated.

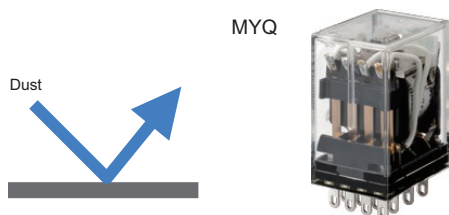

Hermetically Sealed Relays: MYH

These realize excellent reliability even in environments where dust is generated or where corrosive gases (chloride gas, sulfuric gas, silicone gas, etc.) are present.

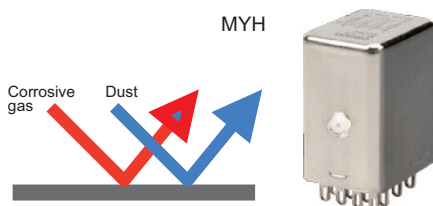

MY

MYK

MYQ-MYH

Common Options (Order Separately)

Common Precautions

MYQ-MYH

Model Number Structure

Model Number Legend

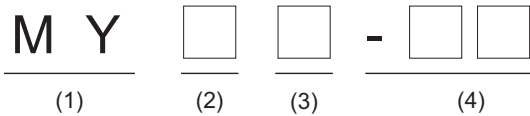

(1) Basic model name

MY: Miniature Power Sealed Relays

(3) Type

None: None
 N: With operation indicator*
 *Only MYQ (plastic sealed relay)

(2) Contacts/seals

Q4: 4-pole, single contacts, plastic sealed relays
 Q4Z: 4-pole, bifurcated contacts, plastic sealed relays
 4H: 4-pole, single contacts, hermetically sealed relays
 4ZH: 4-pole, bifurcated contacts, hermetically sealed relays

(4) Options, terminal type

None: Plug-in terminals
 02: Plastic sealed relays, PCB terminals
 0: Hermetically sealed relays, PCB terminals

Ordering Information

When your order, specify the rated voltage.

Plastic Sealed Relays

●Plug-in terminals

Classification	Number of poles	Contacts	Model	Rated voltage	With operation indicator	
					Model	Rated voltage
Standard models (compliant with Electrical Appliances and Material Safety Act)	4	Single	MYQ4	100/110, 110/120, 200/220, 220/240 VAC 24 VDC	MYQ4N	24, 100/110, 110/120, 200/220, 220/240 VAC 12, 24, 48, 100/110 VDC
		Bifurcated		MYQ4Z		100/110, 110/120, 200/220 VAC 12, 24 VDC

●PCB terminals

Classification	Number of poles	Contacts	Model	Rated voltage
Standard models (compliant with Electrical Appliances and Material Safety Act)	4	Single	MYQ4-02	50, 200/220, 220/240 VAC 24 VDC
		Bifurcated		MYQ4Z-02

Hermetically Sealed Relays

●Plug-in terminals

Classification	Number of poles	Contacts	Model	Rated voltage
Standard models (compliant with Electrical Appliances and Material Safety Act)	4	Single	MY4H	24, 100/110, 110/120 VAC 12, 24, 48, 100/110 VDC
		Bifurcated		MY4ZH

●PCB terminals

Classification	Number of poles	Contacts	Model	Rated voltage
Standard models (compliant with Electrical Appliances and Material Safety Act)	4	Single	MY4H-0	110/120 VAC 24 VDC
		Bifurcated		MY4ZH-0

MY

MYK

MYQ-MYH

Common Options (Order Separately)

Common Precautions

Ratings and Specifications

● Operating coil

Rated voltage (V)	Rated current (mA)		Coil resistance (Ω)	Coil inductance (H)		Must operate voltage (V)*1	Must release voltage (V)*2	Maximum voltage (V)	Power consumption (VA, W)
	50 Hz	60 Hz		Armature OFF	Armature ON				
AC	24	53.8	46	180	0.69	1.3	80% max.	110% max. of rated voltage	Approx. 0.9 to 1.3 (at 60 Hz)
	100/110	11.7/12.9	10/11	3,750	14.54	24.6			
	110/120	9.9/10.8	8.4/9.2	4,430	19.2	32.1			
	200/220	6.2/6.8	5.3/5.8	12,950	54.75	91.07			
	220/240	4.8/5.3	4.2/4.6	18,790	83.5	136.4			
DC	12	75		165	0.734	1.37	10% min.		Approx. 0.9
	24	36.9		650	3.2	5.72			
	48	18.5		2,600	10.6	21.0			
	100/110	9.1/10		11,000	45.6	86.0			

- Note:**
- The rated current and coil resistance are measured at a coil temperature of 23°C with tolerances of +15%/-20% for AC rated current and ±15% for DC coil resistance.
 - The AC coil resistance and coil inductance values are for reference only.
 - Operating characteristics were measured at a coil temperature of 23°C.
 - The maximum voltage capacity was measured at an ambient temperature of 23°C.
- *1. There is variation between products, but actual values are 80% maximum. To ensure operation, apply at least 80% of the rated value.
 *2. There is variation between products, but actual values are 30% minimum for AC and 10% minimum for DC. To ensure release, use a value that is lower than the specified value.

● Contact Ratings

Plastic Sealed Relays: MYQ

Number of poles (contact configuration)	4-pole (4PDT)	
	Single/bifurcated	
	Resistive load	Inductive load (cos φ = 0.4, L/R = 7 ms)
Rated load	1 A at 220 VAC 1 A at 24 VDC	0.5 A at 220 VAC 0.5 A at 24 VDC
Rated carry current	1 A	
Maximum switching voltage	250 VAC 125 VDC	
Maximum switching current	1 A	
Maximum switching power	220 VA 24 W	110 VA 12 W
Contact material	Au plating + Ag	

Hermetically Sealed Relays: MYH

Number of poles (contact configuration)	4-pole (4PDT)			
	Single		Bifurcated	
	Resistive load	Inductive load (cos φ = 0.4, L/R = 7 ms)	Resistive load	Inductive load (cos φ = 0.4, L/R = 7 ms)
Rated load	3 A at 110 VAC 3 A at 24 VDC	0.8 A at 110 VAC 1.5 A at 24 VDC	3 A at 110 VAC 3 A at 24 VDC	0.8 A at 110 VAC 1.5 A at 24 VDC
Rated carry current	3 A			
Maximum switching voltage	125 VAC 125 VDC			
Maximum switching current	3 A			
Maximum switching power	330 VA 72 W	88 VA 36 W	330 VA 72 W	88 VA 36 W
Contact material	Au plating + Ag			

MY

MYK

MYQ·MYH

Common Options (Order Separately)

Common Precautions

Characteristics

Model		MYQ	MYH
Contact resistance*1		50 mΩ max.	
Operate time*2		20 ms max.	
Release time*2		20 ms max.	
Maximum switching frequency	Mechanical	18,000 operations/h	
	Rated load	1,800 operations/h	
Insulation resistance*3		100 MΩ min.	
Dielectric strength	Between coil and contacts	2,000 VAC at 50/60 Hz for 1 min	1,000 VAC at 50/60 Hz for 1 min
	Between contacts of different polarity	2,000 VAC at 50/60 Hz for 1 min	1,000 VAC at 50/60 Hz for 1 min
	Between contacts of the same polarity	1,000 VAC at 50/60 Hz for 1 min	700 VAC at 50/60 Hz for 1 min
Vibration resistance	Destruction	10 to 55 to 10 Hz, 0.5-mm single amplitude (1.0-mm double amplitude)	
	Malfunction	10 to 55 to 10 Hz, 0.5-mm single amplitude (1.0-mm double amplitude)	
Shock resistance	Destruction	1,000 m/s ²	
	Malfunction	200 m/s ²	
Endurance	Mechanical	Single contacts: AC: 50,000,000 operations min., DC: 100,000,000 operations min. Bifurcated contacts: 5,000,000 operations min., DC: 5,000,000 operations min. (switching frequency: 18,000 operations/h)	Single contacts: 50,000,000 operations min. Bifurcated contacts: 5,000,000 operations min. (switching frequency: 18,000 operations/h)
	Electrical*4	Single contacts: 200,000 operations min. Bifurcated contacts: 100,000 operations min. (at rated load, switching frequency: 1,800 operations/h)	Single contacts: 100,000 operations min. Bifurcated contacts: 50,000 operations min. (at rated load, switching frequency: 1,800 operations/h)
Failure rate P Level (reference value)*5		Single contacts: 1 mA at 1 VDC Bifurcated contacts: 100 μA at 1 VDC	Single contacts: 100 μA at 1 VDC Bifurcated contacts: 100 μA at 100 mVDC
Ambient operating temperature*6		-55 to 60°C	-25 to 60°C
Ambient operating humidity		5% to 85%	
Weight		Approx. 35 g	Approx. 50 g

Note: The data shown above are initial values.

- *1. Measurement conditions: 1 A at 5 VDC using the voltage drop method.
- *2. Measurement conditions: With rated operating power applied, not including contact bounce.
Ambient temperature condition: 23°C
- *3. Measurement conditions: For 500 VDC applied to the same location as for dielectric strength measurement.
- *4. Ambient temperature condition: 23°C
- *5. This value was measured at a switching frequency of 120 operations per minute.
- *6. With no icing or condensation.

MY

MYK

MYQ-MYH

Common Options (Order Separately)

Common Precautions

Engineering Data (Reference Value)

MY

MYK

MYQ-MYH

Common Options (Order Separately)

Common Precautions

Maximum Switching Capacity MYQ4(Z)

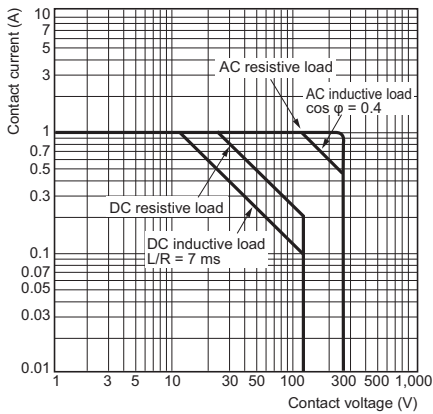

MY4(Z)H

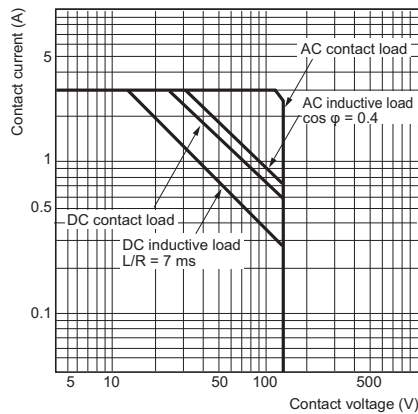

Endurance Curve

MYQ4

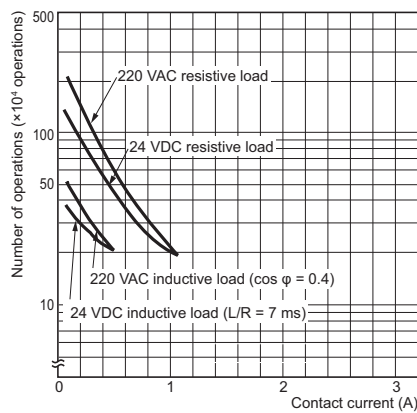

Note: The endurance of bifurcated contacts is one-half that of single contacts.

MY4H

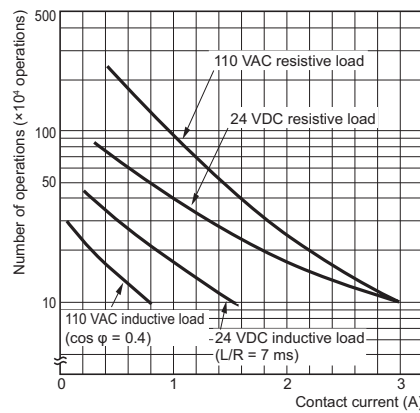

Note: The endurance of bifurcated contacts is one-half that of single contacts.

H₂S Gas Data

MYQ4

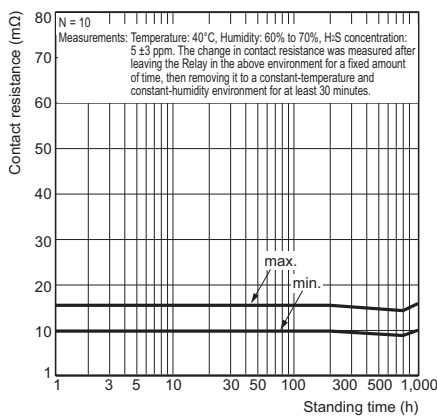

Shock Malfunction

MYQ4

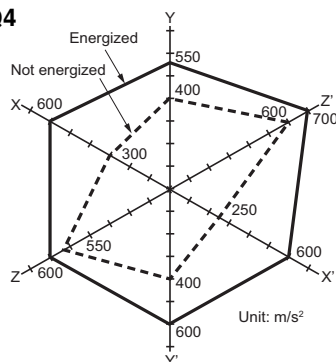

N = 20

Measurement: Shock was applied 3 times each in 6 directions along 3 axes with the Relay energized and not energized to check the shock values that cause the Relay to malfunction.

Criteria: Non-energized: 200 m/s²
Energized: 200 m/s²

Shock direction



● Plug-in terminals

Plastic Sealed Relays

MYQ4(Z)(N)

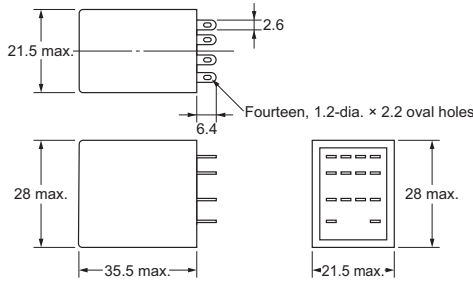
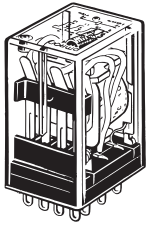

MYQ4(Z)N

DC Models

AC Models

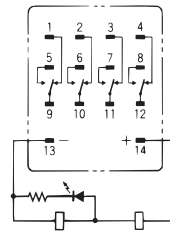

(Coil has polarity)

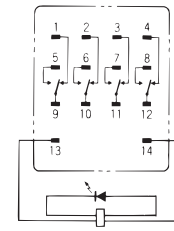

(Coil has no polarity)

- Note:** 1. An AC model has coil disconnection self-diagnosis.
2. For the DC models, check the coil polarity when wiring and wire all connections correctly.

Hermetically Sealed Relays

MY4(Z)H

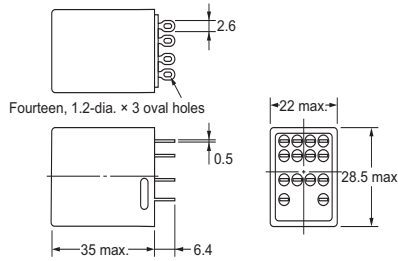
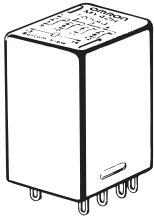

Terminal Arrangement/
Internal Connection Diagram
(Bottom View)
MY4(Z)H

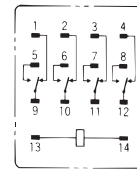

(Coil has no polarity)

● PCB terminals

Plastic Sealed Relays

MYQ4(Z)-02

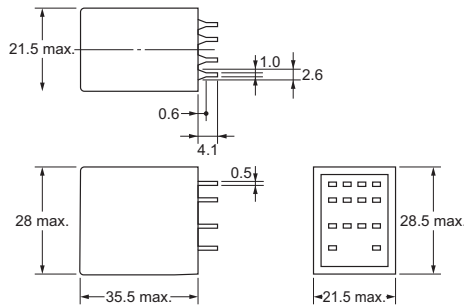
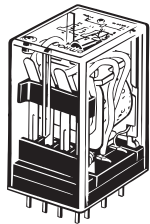

PCB Processing Dimensions
(Bottom View)

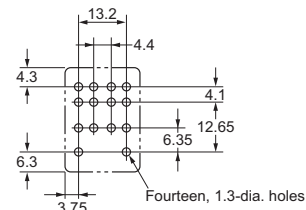

- Note:** The dimensional tolerance is ± 0.1 .

Hermetically Sealed Relays

MY4(Z)H-0

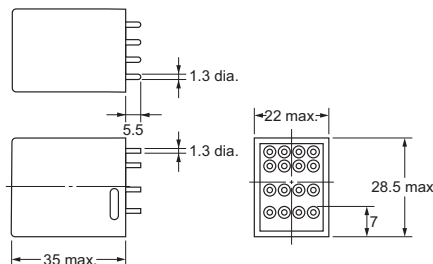
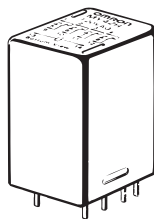

PCB Processing Dimensions
(Bottom View)

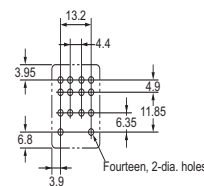

MY

MYK

MYQ-MYH





Common Options (Order Separately)

Common Precautions

Common Options (Order Separately)

Ordering Information

Front-mounting Sockets

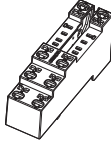
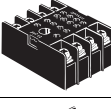
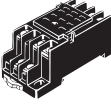
Applicable relay model*1	Mounting Method	Conductive part protection	Terminal Type	Applicable crimp terminal/ Electric wire	Appearance	Mode	Hold-down Clips/ Release Levers (Order Separately)
MY2□ MY2□(S) MY2Z□-CR	Mounted on a DIN track or with screws	Available	Push-In Plus Terminal	Ferrules Solid wire Stranded wire	NEW 	PYF-08-PU*2 * MY2Z□-CR, MY2□-CR 24 VAC cannot be used	With release lever * Hold by release lever
					NEW 	PYF-08-PU-L*2	
		Option (Terminal cover sold separately) *3	Screw terminal (M3 screw size)	Forked terminals Solid wire Stranded wire	NEW 	PYFZ-08-E*4	MY2□: PYC-A1 MY2IN(S): PYC-E1 MY2Z□-CR, MY2□-CR 24 VAC: Y92H-3
					NEW 	PYFZ-08 * Terminal cover: PYCZ-C08	
	Mounted on a DIN track	Available	Screwless terminal (Clamp method)	Solid wire Stranded wire		PYF08S	PYCM-08S * MY2Z□-CR, MY2□-CR 24 VAC cannot be used * Hold by release lever
		Screw mounting only	None	Screw terminal (M3.5 screw size)	Round terminals Forked terminals Solid wire Stranded wire		PYF08M
MY3□	Mounted on a DIN track or with screws	None	Screw terminal (M3 screw size)	Round terminals Forked terminals Solid wire Stranded wire		PYF11A	PYC-A1

*1. The applicable relay model is a plug-in terminal type.
 *2. There are screw mounting holes in the DIN hooks on the PYF-□□-PU and P2RF-□□-PU. Pull out the DIN hook tabs to mount the Sockets with screws.
 *3. Terminal cover type is PYCZ-C08. (Order Separately) For details, refer to the *For Screw Terminal Sockets (PYFZ-08/PYFZ-14) Terminal covers* on page 43.
 *4. The finger-protection type (PYFZ-□-E) is a type in which the terminal cover is integrated into the socket. Round terminals cannot be used. Use forked terminals or ferrules instead.

MY





MYK

MYQ-MYH

Common Options (Order Separately)

Common Precautions

MY/MYK/MYQ-MYH

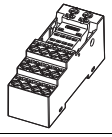
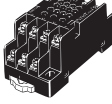
Applicable relay model*1	Mounting Method	Conductive part protection	Terminal Type	Applicable crimp terminal/ Electric wire	Appearance	Mode	Hold-down Clips/ Release Levers (Order Separately)
MY MYK MY4□ MY4□(S) MY4□H MYQ4□ MY4Z□-CBG-CR MY2K	Mounted on a DIN track or with screws	Available	Push-In Plus Terminal	Ferrules Solid wire Stranded wire	NEW 	PYF-14-PU*2 * MY4ZN-CBG-CR, MY4-CR 24 VAC, MY4N-CR 24 VAC/115 VAC cannot be used	With release lever * Hold by release lever
					NEW 	PYF-14-PU-L*2	
		Option (Terminal cover sold separately) *3	Screw terminal (M3 screw size)	Forked terminals Solid wire Stranded wire	NEW 	PYFZ-14-E*4	MY4Z□-CBG-CR, MY4-CR 24 VAC, MY4N-CR 24 VAC/115 VA: Y92H-3 Other than those above: PYC-A1
					NEW 	PYFZ-14 * Terminal cover: PYCZ-C14	
	Mounted on a DIN track	Available	Screwless terminal (Clamp method)	Solid wire Stranded wire		PYF14S	PYCM-14S * MY4Z□-CBG-CR, MY4-CR 24 VAC, MY4N-CR 24 VAC/115 VAC cannot be used * Hold by release lever
	Mounted on a DIN track or with screws	None	Screw terminal (M3.5 screw size)	Round terminals Forked terminals Solid wire Stranded wire		PYF14T	MY4Z□-CBG-CR: Y92H-3 Other than those above: PYC-A1

- *1. The applicable relay model is a plug-in terminal type.
- *2. There are screw mounting holes in the DIN hooks on the PYF-□□-PU and P2RF-□□-PU. Pull out the DIN hook tabs to mount the Sockets with screws.
- *3. Terminal cover type is PYCZ-C14. (Order Separately) For details, refer to the *For Screw Terminal Sockets (PYFZ-08/PYFZ-14) Terminal covers* on page 43.
- *4. The finger-protection type (PYFZ-□-E) is a type in which the terminal cover is integrated into the socket. Round terminals cannot be used. Use forked terminals or ferrules instead.

MY



MYK

MYQ-MYH

Common Options (Order Separately)

Common Precautions

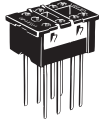
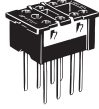
Back-mounting Sockets

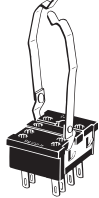
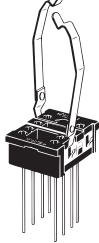
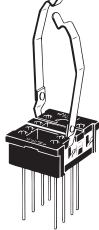
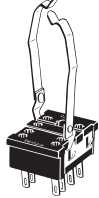
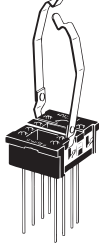
Applicable relay model*1	Terminal Type	Hold-down Clips	Appearance	Mode
MY2□ MY2□(S) MY2Z□-CR	Solder terminals	Accessories (Order Separately) * MY2Z□-CR: PYC-1 Other than those above: PYC-P		PY08
	Wrapping terminals Terminal length: 25 mm			PY08QN
	Wrapping terminals Terminal length: 20 mm			PY08QN2
	PCB terminals			PY08-02
MY2□ MY2□(S)	Solder terminals	With Hold-down Clips*2		PY08-Y1
	Wrapping terminals Terminal length: 25 mm			PY08QN-Y1
	Wrapping terminals Terminal length: 20 mm			PY08QN2-Y1
MY2Z□-CR	Solder terminals	With Hold-down Clips*2		PY08-Y3
	Wrapping terminals Terminal length: 25 mm			PY08QN-Y3

*1. The applicable relay model is a plug-in terminal type.

*2. The hold-down clips for connecting the relay and socket come as a set with the socket.

MY

MYK

MYQ-MYH

Common Options (Order Separately)

Common Precautions

MY/MYK/MYQ-MYH



MY

MYK

MYQ-MYH



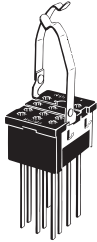



Common Options (Order Separately)

Common Precautions

Applicable relay model*1	Terminal Type	Hold-down Clips	Appearance	Mode
MY2Z□-CR	Wrapping terminals Terminal length: 20 mm	With Hold-down Clips*2		PY08QN2-Y3
MY3□	Solder terminals	Accessories (Order Separately) * PYC-P		PY11
		With Hold-down Clips*2		PY11-Y1
	Wrapping terminals Terminal length: 25 mm	Accessories (Order Separately) * PYC-P		PY11QN
		With Hold-down Clips*2		PY11QN-Y1
	Wrapping terminals Terminal length: 20 mm	Accessories (Order Separately) * PYC-P		PY11QN2
		With Hold-down Clips*2		PY11QN2-Y1
	PCB terminals	Accessories (Order Separately) * PYC-P		PY11-02
	MY4□ MY4□(S) MY4□H MYQ4□ MY4Z□-CBG-CR MY2K	Solder terminals	Accessories (Order Separately) * MY4Z□-CBG-CR: PYC-1 Other than those above: PYC-P	
Wrapping terminals Terminal length: 25 mm				PY14QN

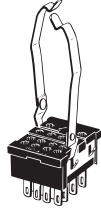
*1. The applicable relay model is a plug-in terminal type.

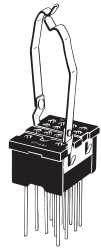
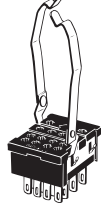
*2. The hold-down clips for connecting the relay and socket come as a set with the socket.

Applicable relay model*1	Terminal Type	Hold-down Clips	Appearance	Mode
MY4□ MY4□(S) MY4□H MYQ4□ MY4Z□-CBG-CR MY2K	Wrapping terminals Terminal length: 20 mm	Accessories (Order Separately) * MY4Z□-CBG-CR: PYC-1 Other than those above: PYC-P		PY14QN2
	PCB terminals			PY14-02
MY4□ MY4□(S) MY4□H MYQ4□ MY2K	Solder terminals	With Hold-down Clips*2		PY14-Y1
	Wrapping terminals Terminal length: 25 mm			PY14QN-Y1
	Wrapping terminals Terminal length: 20 mm			PY14QN2-Y1
Solder terminals			PY14-Y3	
MY4Z□-CBG-CR	Wrapping terminals Terminal length: 25 mm			PY14QN-Y3
	Wrapping terminals Terminal length: 20 mm			PY14QN2-Y3

MY

MYK

MYQ-MYH

Common Options (Order Separately)



Common Precautions

*1. The applicable relay model is a plug-in terminal type.

*2. The hold-down clips for connecting the relay and socket come as a set with the socket.

MY/MYK/MYQ-MYH

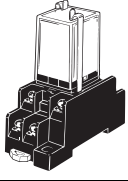
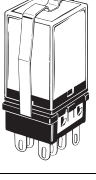
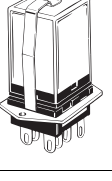
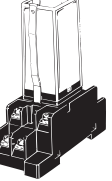
Hold-down Clip

Appearance*1	Model*2	Weight*3	Application	
	PYC-A1	Approx. 0.54 g	For connecting relays and sockets	
	PYC-E1	Approx. 0.6 g		
	PYC-P	Approx. 1.4 g		
	PYC-S	Approx. 1.8 g		For connecting sockets, socket mounting plates, and relays
	Y92H-3*4	Approx. 0.7 g		For connecting models with built-in CR circuit for coil surge absorption (MY2Z□-CR) and sockets
	PYC-1*5	Approx. 6 g		

*1. The appearance shown is one in which the relay, socket, and hold-down clip are assembled.

*2. Hold-down clips are used in sets of two. However, PYC-P and PYC-1.

*3. The weight shown above is the weight for one hold-down clip.

*4. MY2-CR 24 VAC, MY2N-CR 24 VAC, MY4-CR 24 VAC and MY4N-CR 24 VAC/115 VAC use in combination with hold-down clip Y92H-3.

*5. MY2-CR 24 VAC, MY2N-CR 24 VAC, MY4-CR 24 VAC and MY4N-CR 24 VAC/115 VAC use in combination with hold-down clip PYC-1.

Common Options (Order Separately)

Common Precautions

●Front-connecting Socket Accessories

For Push-In Plus Terminal Sockets (PYF-08-PU(-L)/PYF-14-PU(-L))

Short Bars

Applicable sockets	Pitch	Application	Shape/external dimensions	Number of poles	L (Length)	Insulation on color	Model*1
PYF-08-PU(-L) PYF-14PU(-L)	7.75 mm	Bridging contact terminals (common)		2	15.1	Red (R) Blue (S) Yellow(Y)	PYDN-7.75-020□
				3	22.85		PYDN-7.75-030□
				4	30.6		PYDN-7.75-040□
				20	154.6		PYDN-7.75-200□
	31.0 mm	For Coil terminals		8	224.35		PYDN-31.0-080□

*1. Replace the box (□) in the model number with the code for the covering color. □Color selection: R = Red, S = Blue, Y = Yellow

Labels

Applicable sockets	Model
PYF-08-PU(-L) PYF-14PU(-L)	XW5Z-P4.0LB1 (1 sheet/60 pieces)

For Screwless Terminal Sockets (PYF08S/PYF14S)

Short Bars

Applicable sockets	Pitch	Application	Shape/external dimensions	Number of poles	Insulation on color	Model*1
PYF08S	19.7 mm	For bridging coils between sockets		2	Red (R) Blue (B)	PYDM-08S□ (50 pcs./bag)
PYF14S	27.5 mm			2		PYDM-14S□ (50 pcs./bag)

*1. Replace the box (□) in the model number with the code for the covering color. □Color selection: R = Red, B = Blue

Labels

Applicable sockets	Model
PYF08S	R99-11 (100 pcs./bag)
PYF14S	

Release Levers

Applicable sockets	Shape/external dimensions	Model
PYF08S		PYCM-08S
PYF14S		PYCM-14S

MY

MYK

MYQ·MYH

Common Options (Order Separately)

Common Precautions

MY/MYK/MYQ-MYH

For Screw Terminal Sockets (PYFZ-08/PYFZ-14) Short Bars

Applicable sockets	Pitch	Application	Shape/external dimensions	Number of poles	Insulation color	Model*1
PYFZ-08	22 mm	For bridging adjacent sockets		2	B (Black) S (Blue) R (Red)	PYD-025B□ (2P) (10 pcs./bag)
				8		PYD-085B□ (8P) (10 pcs./bag)
PYFZ-14	29 mm	For bridging adjacent sockets		2	B (Black) S (Blue) R (Red)	PYD-026B□ (2P) (10 pcs./bag)
				8		PYD-086B□ (8P) (10 pcs./bag)
Common Options (Order Separately)	7 mm	For bridging with the same socket		2	B (Black) Y (Yellow)	PYD-020B□ (2P) (50 pcs./bag)
				3		PYD-030B□ (3P) (10 pcs./bag)

*1. Replace the box (□) in the model number with the code for the covering color.

MY

MYK

MYQ-MYH

Common Options (Order Separately)

Common Precautions

For Screw Terminal Sockets (PYFZ-08/PYFZ-14)

Terminal covers

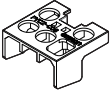
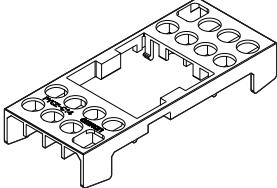
Applicable sockets	Appearance	Model
PYFZ-08		PYCZ-C08 (2 pcs/set)
PYFZ-14		PYCZ-C14 (1 pcs/set)

Note: These covers cannot be used for PYF08A and PYF14A.

Dimensions with terminal cover

(Unit: mm)

PYCZ-C08

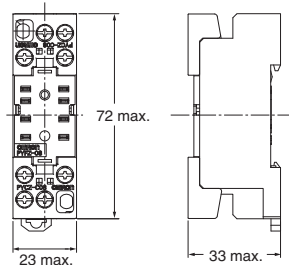

PYCZ-C14

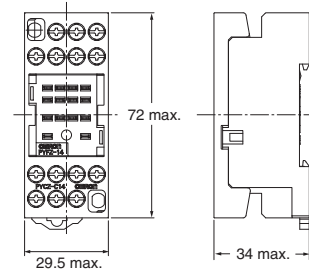

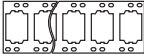
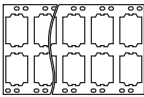

Socket Mounting Plates (For Back-connecting Socket PY□/Solder Terminals, PY□QN(2)/Wrapping Terminals)

Applicable Sockets		Socket Mounting Plates		
Model	Models with hold-down clips	Appearance	Number of sockets	Model
PY08 PY08QN PY08QN2	PY08-Y1, PY08-Y3 PY08QN-Y1, PY08QN-Y3 PY08QN2-Y1, PY08QN2-Y3		1	PYP-1
PY11 PY11QN PY11QN2	PY11-Y1 PY11QN-Y1 PY11QN2-Y1		18	PYP-18*
PY14 PY14QN PY14QN2	PY14-Y1, PY14-Y3 PY14QN-Y1, PY14QN-Y3 PY14QN2-Y1, PY14QN2-Y3		36	PYP-36*

*You can cut the PYP-18 and PYP-36 to any required length.

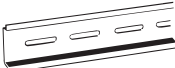
Parts for Track Mounting

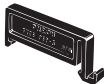
Type	Appearance	Model
DIN Tracks		PFP-100N
		PFP-50N
End Plate*		PFP-M
Spacer		PFP-S

Note: The track conforms to DIN standards.

*When mounting DIN track, please use End Plate (Model PFP-M).

MY

MYK

MYQ-MYH

Common Options (Order Separately)

Common Precautions

Ratings and Specifications

Characteristics

Sockets

MY

MYK

MYQ-MYH

Common Options (Order Separately)

Common Precautions

Model	Connection	Number of pins	Terminal Type	Ambient operating temperature	Ambient operating humidity	Continuous carry current	Dielectric strength			Insulation resistance *1	Weight																			
							Between contact terminals of same polarity	Between contact terminals of different polarity	Between coil and contact terminals																					
PYF-08-PU	Front	8	Push-In Plus Terminal	-40 to 70°C	5% to 85%	10 A*2	2,000 VAC for 1 min	2,000 VAC for 1 min	2,000 VAC for 1 min	1,000 MΩ min. (500 VAC)	Approx. 80 g																			
PYF08S			Screwless terminal	-55 to 70°C							10 A	2,250 VAC for 1 min	2,250 VAC for 1 min	2,250 VAC for 1 min	Approx. 46 g															
PYFZ-08			Screw terminal			-55 to 70°C	10 A	2,250 VAC for 1 min	2,250 VAC for 1 min						2,250 VAC for 1 min	Approx. 32 g														
PYFZ-08-E				Screw terminal							-55 to 70°C	10 A	2,250 VAC for 1 min	2,250 VAC for 1 min		2,250 VAC for 1 min	Approx. 32 g													
PYF08M		11	Screw terminal			-55 to 70°C	5 A	1,500 VAC for 1 min	1,500 VAC for 1 min						1,500 VAC for 1 min		Approx. 26 g													
PYF11A				11			Screw terminal	-55 to 70°C	5 A		2,000 VAC for 1 min	2,000 VAC for 1 min	2,000 VAC for 1 min	Approx. 43 g																
PYF-14-PU		14	Push-In Plus Terminal			-40 to 70°C			6 A		2,000 VAC for 1 min	2,000 VAC for 1 min	2,000 VAC for 1 min	Approx. 87 g																
PYF14S			Screwless terminal	-55 to 70°C		5 A	2,000 VAC for 1 min	2,000 VAC for 1 min	2,000 VAC for 1 min		Approx. 62 g																			
PYFZ-14			Screw terminal			-55 to 70°C	6 A	2,250 VAC for 1 min	2,250 VAC for 1 min		2,250 VAC for 1 min	Approx. 50 g																		
PYFZ-14-E							Screw terminal	-55 to 70°C	6 A		2,250 VAC for 1 min	2,250 VAC for 1 min	2,250 VAC for 1 min	Approx. 50 g																
PYF14T									Screw terminal		-55 to 70°C	3 A	2,000 VAC for 1 min	2,000 VAC for 1 min	2,000 VAC for 1 min	Approx. 53 g														
PY08												8	Solder terminals	-55 to 70°C	7 A	1,500 VAC for 1 min	1,500 VAC for 1 min	1,500 VAC for 1 min	100 MΩ min.	Approx. 8 g										
PY08-Y1		Solder terminals	-55 to 70°C			7 A														1,500 VAC for 1 min	1,500 VAC for 1 min	1,500 VAC for 1 min	100 MΩ min.	Approx. 9 g						
PY08-Y3				Solder terminals			-55 to 70°C	7 A																1,500 VAC for 1 min	1,500 VAC for 1 min	1,500 VAC for 1 min	100 MΩ min.	Approx. 9 g		
PY08QN	Solder terminals				-55 to 70°C				7 A	1,500 VAC for 1 min	1,500 VAC for 1 min																	1,500 VAC for 1 min	100 MΩ min.	Approx. 12 g
PY08QN-Y1													Wrapping terminals (Terminal length: 25 mm)																	-55 to 70°C
PY08QN-Y3		Wrapping terminals (Terminal length: 25 mm)	-55 to 70°C			7 A														1,500 VAC for 1 min	1,500 VAC for 1 min	1,500 VAC for 1 min	100 MΩ min.							
PY08QN2				Wrapping terminals (Terminal length: 20 mm)			-55 to 70°C	7 A					1,500 VAC for 1 min											1,500 VAC for 1 min	1,500 VAC for 1 min	100 MΩ min.	Approx. 11 g			
PY08QN2-Y1	Wrapping terminals (Terminal length: 20 mm)	-55 to 70°C	7 A		1,500 VAC for 1 min	1,500 VAC for 1 min			1,500 VAC for 1 min	100 MΩ min.	Approx. 12 g																			
PY08QN2-Y3				Wrapping terminals (Terminal length: 20 mm)			-55 to 70°C	7 A			1,500 VAC for 1 min		1,500 VAC for 1 min							1,500 VAC for 1 min	100 MΩ min.	Approx. 12 g								
PY08-02	PCB terminals	-55 to 70°C	7 A		1,500 VAC for 1 min	1,500 VAC for 1 min			1,500 VAC for 1 min	100 MΩ min.												Approx. 7 g								
PY11	11			Solder terminals			-55 to 70°C	5 A			1,500 VAC for 1 min		1,500 VAC for 1 min							1,500 VAC for 1 min	100 MΩ min.	Approx. 9 g								
PY11-Y1		Solder terminals	-55 to 70°C		5 A	1,500 VAC for 1 min			1,500 VAC for 1 min	1,500 VAC for 1 min												100 MΩ min.	Approx. 10 g							
PY11QN																							Solder terminals	-55 to 70°C	5 A	1,500 VAC for 1 min	1,500 VAC for 1 min	1,500 VAC for 1 min	100 MΩ min.	Approx. 13 g
PY11QN-Y1																														Wrapping terminals (Terminal length: 25 mm)
PY11QN2				Wrapping terminals (Terminal length: 25 mm)								-55 to 70°C		5 A	1,500 VAC for 1 min	1,500 VAC for 1 min	1,500 VAC for 1 min	100 MΩ min.	Approx. 12 g											
PY11QN2-Y1		Wrapping terminals (Terminal length: 20 mm)	-55 to 70°C		5 A	1,500 VAC for 1 min			1,500 VAC for 1 min	1,500 VAC for 1 min									100 MΩ min.			Approx. 13 g								
PY11-02	PCB terminals			-55 to 70°C			5 A	1,500 VAC for 1 min			1,500 VAC for 1 min	1,500 VAC for 1 min	100 MΩ min.	Approx. 8 g																
PY14	14	Solder terminals	-55 to 70°C		3 A	1,500 VAC for 1 min			1,500 VAC for 1 min	1,500 VAC for 1 min				100 MΩ min.	Approx. 10 g															
PY14-Y1				Solder terminals			-55 to 70°C	3 A			1,500 VAC for 1 min	1,500 VAC for 1 min	1,500 VAC for 1 min		100 MΩ min.	Approx. 11 g														
PY14-Y3																Solder terminals	-55 to 70°C	3 A	1,500 VAC for 1 min	1,500 VAC for 1 min	1,500 VAC for 1 min	100 MΩ min.	Approx. 11 g							
PY14QN																							Solder terminals	-55 to 70°C	3 A	1,500 VAC for 1 min	1,500 VAC for 1 min	1,500 VAC for 1 min	100 MΩ min.	Approx. 14 g
PY14QN-Y1		Wrapping terminals (Terminal length: 25 mm)																												-55 to 70°C
PY14QN-Y3				Wrapping terminals (Terminal length: 25 mm)			-55 to 70°C	3 A			1,500 VAC for 1 min	1,500 VAC for 1 min	1,500 VAC for 1 min		100 MΩ min.															
PY14QN2		Wrapping terminals (Terminal length: 20 mm)														-55 to 70°C	3 A	1,500 VAC for 1 min	1,500 VAC for 1 min	1,500 VAC for 1 min	100 MΩ min.	Approx. 13 g								
PY14QN2-Y1				Wrapping terminals (Terminal length: 20 mm)			-55 to 70°C	3 A			1,500 VAC for 1 min	1,500 VAC for 1 min	1,500 VAC for 1 min		100 MΩ min.							Approx. 14 g								
PY14QN2-Y3		Wrapping terminals (Terminal length: 20 mm)														-55 to 70°C	3 A	1,500 VAC for 1 min	1,500 VAC for 1 min	1,500 VAC for 1 min	100 MΩ min.	Approx. 14 g								
PY14-02				PCB terminals			-55 to 70°C	3 A			1,500 VAC for 1 min	1,500 VAC for 1 min	1,500 VAC for 1 min		100 MΩ min.							Approx. 9 g								

*1. For 500 VDC applied to the same location as for dielectric strength measurement.
 *2. The carrying current of 10 A is for an ambient temperature of 55°C or below. At an ambient temperature of 70°C, the value is 7 A.
 *3. This model is a set including a socket and relay hold-down clips. This weight shown is the total including the socket and relay hold-down clips.

Socket Accessories

●For Front-connecting Sockets

Short Bars

Application	Applicable sockets	Model	Maximum carry current	Ambient operating temperature	Ambient operating humidity			
Bridging contact terminals (common)	PYF-08-PU(-L) PYF-14-PU(-L)	PYDN-7.75-020□	20 A	-40 to 70°C	5% to 85%			
		PYDN-7.75-030□						
		PYDN-7.75-040□						
		PYDN-7.75-200□						
	PYFZ-08	PYD-025B□	20 A (However, 18 A when 70°C)	-40 to 70°C (with no icing or condensation)	45% to 85% (with no icing or condensation)			
		PYD-085B□						
	PYFZ-14	PYD-026B□						
		PYD-086B□						
		PYD-020B□						
		PYD-030B□						
For Coil terminals	PYF-08-PU(-L) PYF-14-PU(-L)	PYDN-31.0-080□				20 A	-40 to 70°C	5% to 85%
	PYF08S	PYDM-08S□				10 A	-40 to 70°C	5% to 85%
	PYF14S	PYDM-14S□	10 A	-40 to 70°C	5% to 85%			

Certified Standards

●CSA certification (File No. LR031928)

Model	Ratings	Class number	Standard number
PYF-08-PU	10 A, 250 V	3211 07	CSA C22.2 No14
PYF-14-PU	6 A, 250 V*		
PYF08S	10 A, 250 V		
PYF14S	5 A, 250 V		
PYFZ-08(-E)	10 A, 250 V		
PYFZ-14(-E)	6 A, 250 V		
PY□ PYF□A	7 A, 250 V		

*When power is supplied to all four poles, use with a total power current that does not exceed 20 A.

●UL certification (File No. E87929)

Model	Ratings	Standard number	Category	Listed/Recognized
PYF-08-PU	10 A, 250 V	UL508	SWIV2	Recognition
PYF-14-PU	6 A, 250 V*			
PYF08S PYF14S	10 A, 250 V			
PYFZ-08(-E)	10 A, 250 V			
PYFZ-14(-E)	6 A, 250 V			
PY□ PYF□A	7 A, 250 V			

*When power is supplied to all four poles, use with a total power current that does not exceed 20 A.

●TÜV Rheinland certification

Model	Ratings	Standard number	Certification No.
PYF-08-PU	10 A, 250 V*	EN 61984	R50327595
PYF-14-PU	6 A, 250 V		
PYFZ-08(-E)	10 A, 250 V		R50405329
PYFZ-14(-E)	6 A, 250 V		

*Ratings are for an ambient temperature of 55°C or below. At an ambient temperature of 70°C, the value is 7 A.

●VDE certification

Model	Standard number	Certification No.
PYF08S	VDE0627 (EN61984)	40015509
PYF14		

MY

MYK

MYQ-MYH

Common Options (Order Separately)

Common Precautions

Dimensions

Height with Socket

●Front-connecting Sockets

- Push-In Plus Terminal (PYF-□-PU)

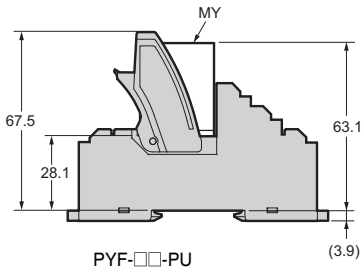

- Screwless terminal (PYF08S, PYF14S)

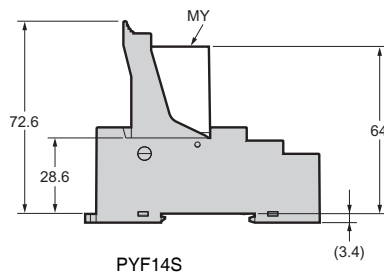
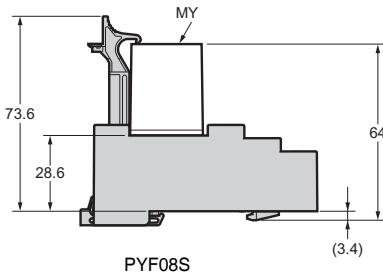

- Screw terminal (PYFZ-□(-E), PYF11A, PYF14T, PYF08M)

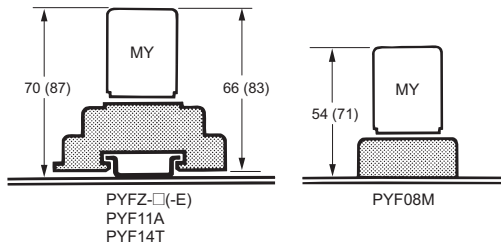

- Note:**
1. The PYF11A can be mounted on a track or with screws.
 2. The heights given in parentheses are the measurements for 53-mm-high Relays.
 3. Use the PYC-P Hold-down Clip for the PYF08M.

●Back-connecting Sockets

- Solder terminals/wrapping terminals (PY□)

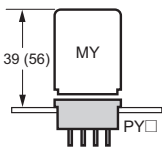

- PCB terminals (PY□-02)

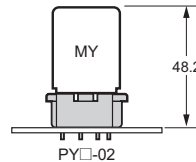

MY

MYK

MYQ-MYH

Common Options (Order Separately)

Common Precautions

Front-connecting Sockets

● Push-In Plus Terminal

PYF-08-PU(-L)

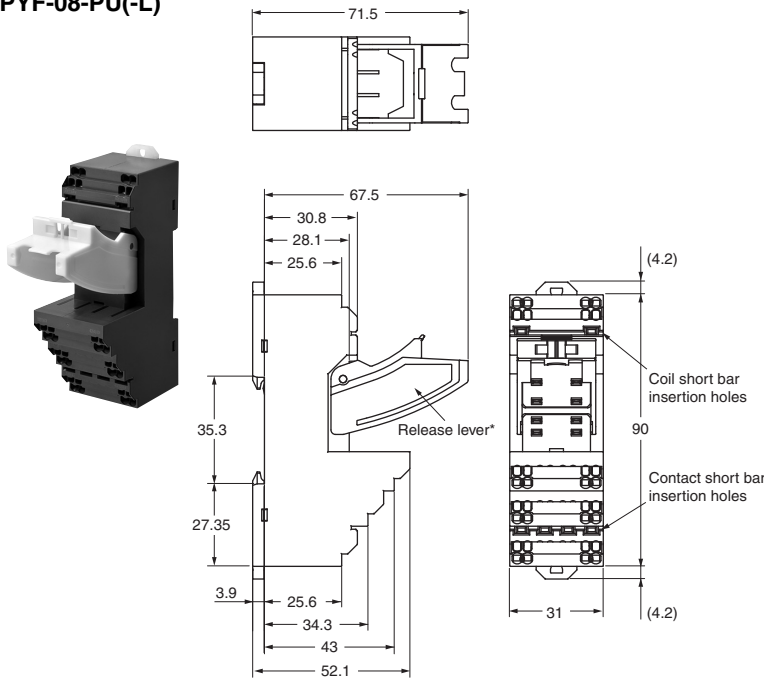

Terminal Arrangement/Internal Connection Diagram (Top View)

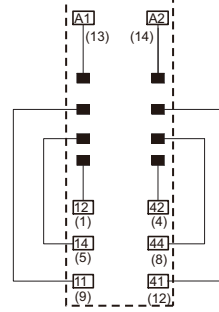

Note: The numbers in parentheses are traditionally used terminal numbers.

Mounting Hole Dimensions

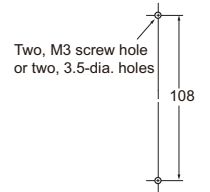

Note: Pull out the hooks to mount the Socket with screws.

* The PYF-08-PU-L Sockets do not have release levers.

PYF-14-PU(-L)

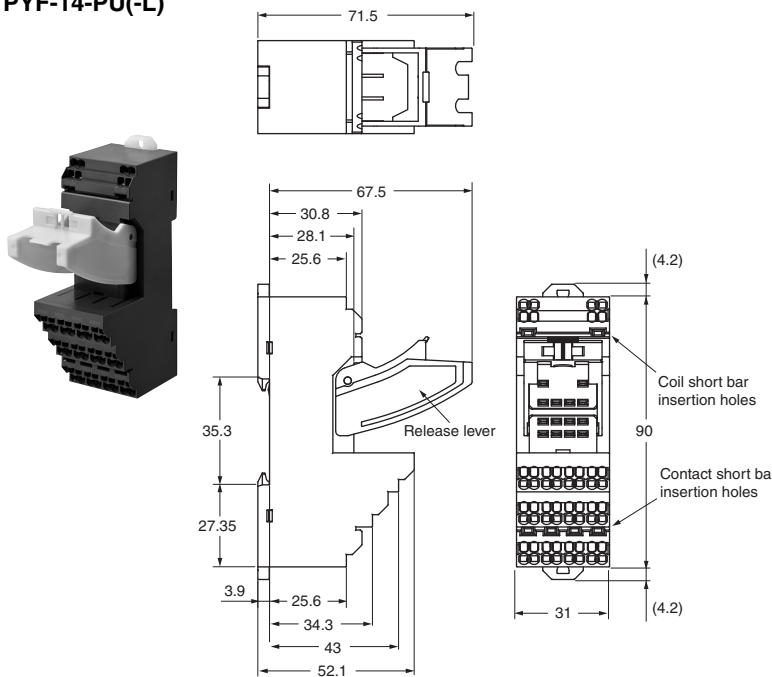

Terminal Arrangement/Internal Connection Diagram (Top View)

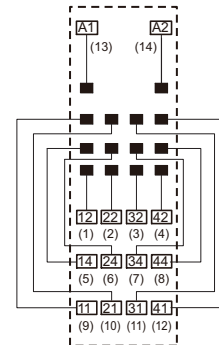

Note: The numbers in parentheses are traditionally used terminal numbers.

Mounting Hole Dimensions

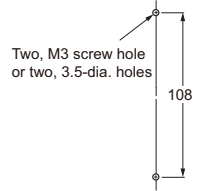

Note: Pull out the hooks to mount the Socket with screws.

* The PYF-14-PU-L Sockets do not have release levers.

MY

MYK

MYQ·MYH

Common Options (Order Separately)

Common Precautions

MY/MYK/MYQ-MYH

●Screwless terminal

PYF08S

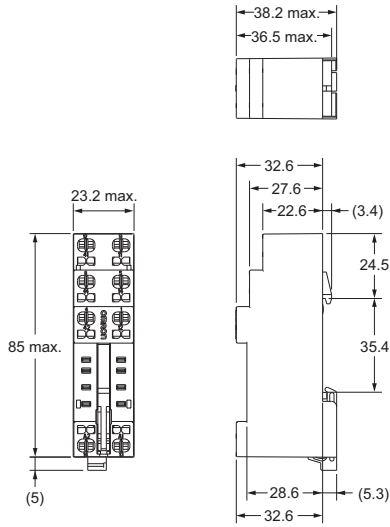
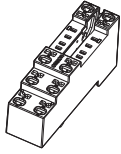

Terminal Arrangement/Internal Connection Diagram

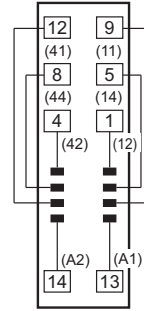

(Top View)

Note: The number shown in parentheses is the DIN standard.

PYF14S

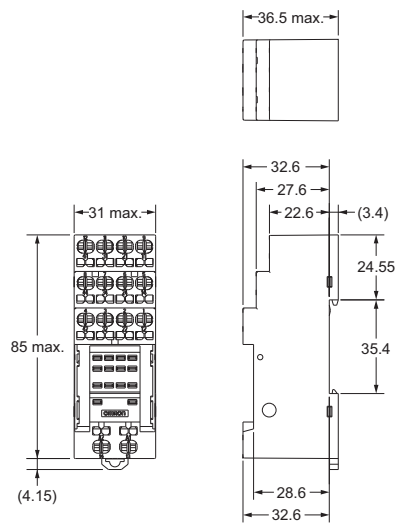
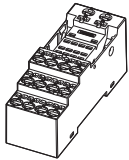

Terminal Arrangement/Internal Connection Diagram

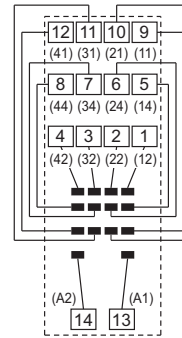

(Top View)

Note: The number shown in parentheses is the DIN standard.

MY

MYK

MYQ-MYH

Common Options (Order Separately)

Common Precautions

Front-connecting Sockets
● Screw terminal

PYFZ-08

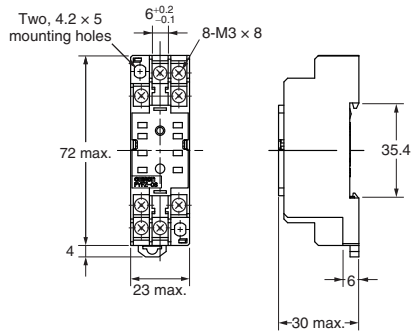

Terminal Arrangement/
Internal Connection Diagram

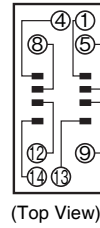

Mounting Hole Dimensions

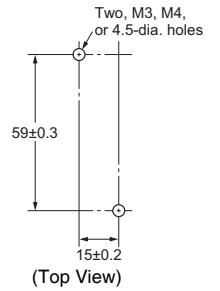

PYFZ-08-E
(Finger-protection structure)

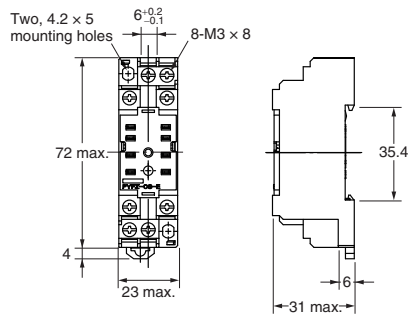

(Top View)

(Top View)

Note: Track mounting is also possible.

PYF08M

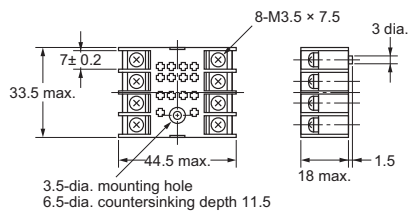
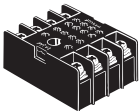

Terminal Arrangement/Internal
Connection Diagram

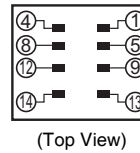

(Top View)

Mounting Hole Dimensions

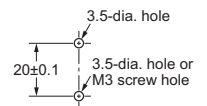

PYF11A

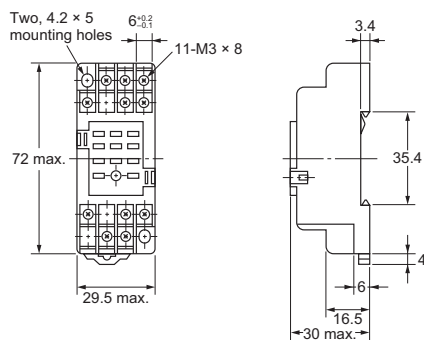
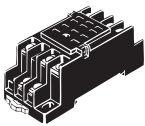

Terminal Arrangement/Internal
Connection Diagram

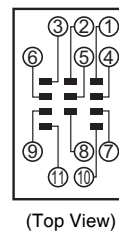

(Top View)

Mounting Hole Dimensions

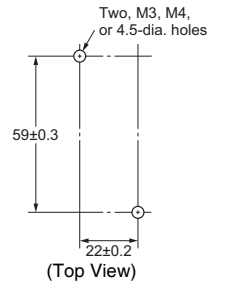

Note: Track mounting is also possible.

MY

MYK

MYQ-MYH

Common Options (Order Separately)

Common Precautions

MY/MYK/MYQ-MYH

MY

PYFZ-14

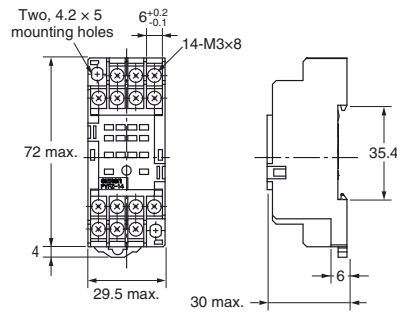

Mounting Hole Dimensions

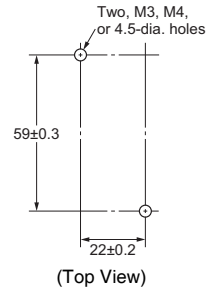

MYK

PYFZ-14-E (Finger-protection structure)

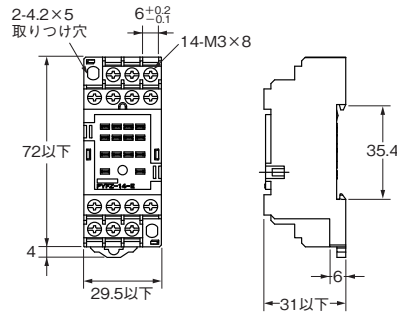

Terminal Arrangement/Internal Connection Diagram

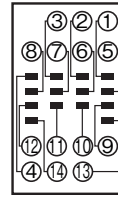

Note: Track mounting is also possible.

MYQ-MYH

PYF14T

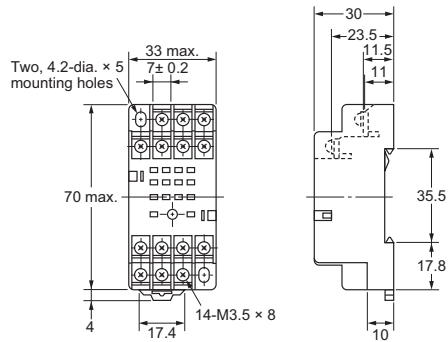
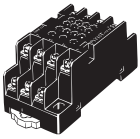

Mounting Hole Dimensions

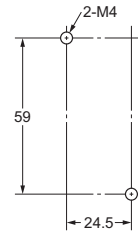

Common Options (Order Separately)

Common Precautions

Back-connecting Socket
●Solder terminals

PY08

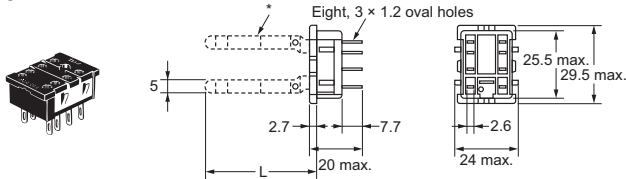

*PY08-Y□ includes the portion indicated by broken line.

Terminal Arrangement/Internal Connection Diagram

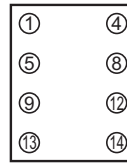

(Bottom View)

Mounting Hole Dimensions

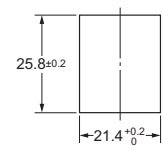

PY11
PY11-Y1

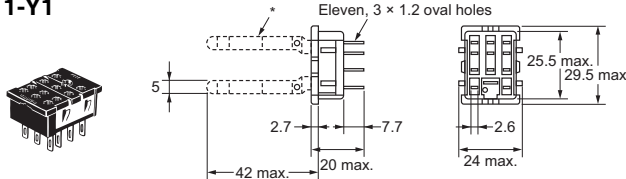

*PY11-Y1 includes the portion indicated by broken line.

Terminal Arrangement/Internal Connection Diagram



(Bottom View)

Mounting Hole Dimensions

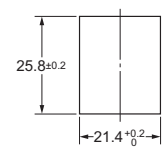

PY14
PY14-Y1
PY14-Y3

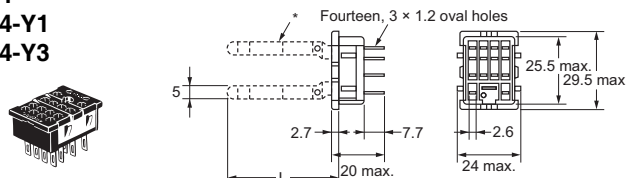

*PY14-Y□ includes the portion indicated by broken line.

Terminal Arrangement/Internal Connection Diagram



(Bottom View)

Mounting Hole Dimensions

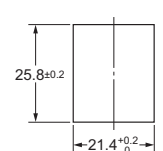

●Wrapping terminals

PY08QN
PY08QN2
PY08QN2-Y1
PY08QN2-Y3

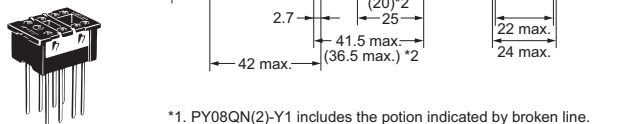

*1. PY08QN(2)-Y1 includes the portion indicated by broken line.
 *2. Dimensions in parentheses are for PY08QN2(-Y1).

Terminal Arrangement/Internal Connection Diagram

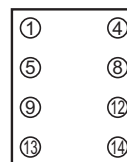

(Bottom View)

Mounting Hole Dimensions

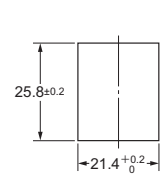

PY11QN
PY11QN2
PY11QN-Y1
PY11QN2-Y1

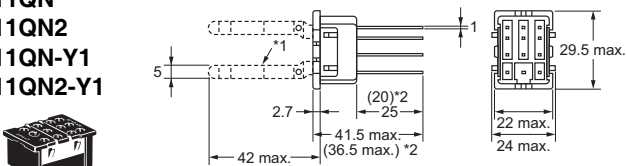

*1. PY11QN(2)-Y1 includes the portion indicated by broken line.
 *2. Dimensions in parentheses are for PY11QN2(-Y1).

Terminal Arrangement/Internal Connection Diagram

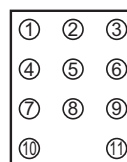

(Bottom View)

Mounting Hole Dimensions

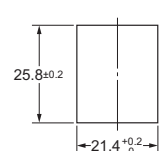

PY14QN/PY14QN2
PY14QN-Y1/PY14QN2-Y1
PY14QN-Y3 (L = 60 max.)
PY14QN2-Y3 (L = 60 max.)

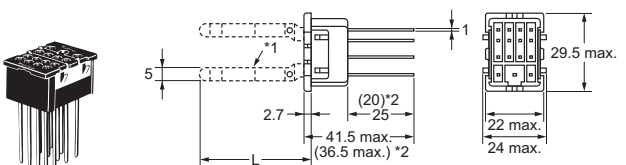

*1. PY14QN-Y□ and PY14QN2-Y□ include the portion indicated by broken line.
 *2. Dimensions in parentheses are for PY14QN2(-Y□).

Terminal Arrangement/Internal Connection Diagram

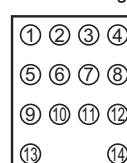

(Bottom View)

Mounting Hole Dimensions

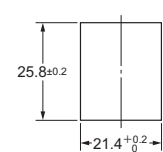

MY

MYK

MYQ-MYH

Common Options (Order Separately)

Common Precautions

●PCB terminals

PY08-02

• This is not a flux-tight structure. We recommend manual soldering for this product.

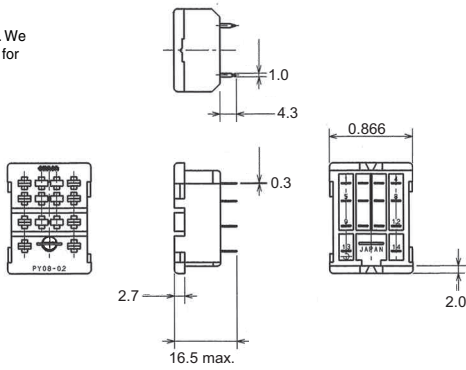

Terminal Arrangement/Internal Connection Diagram

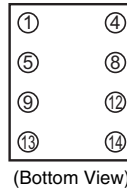

Mounting Hole and PCB Dimensions

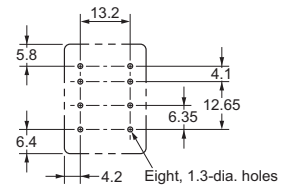

PY11-02

• This is not a flux-tight structure. We recommend manual soldering for this product.

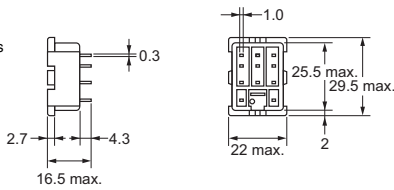

Terminal Arrangement/Internal Connection Diagram

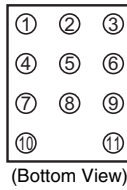

Mounting Hole and PCB Dimensions

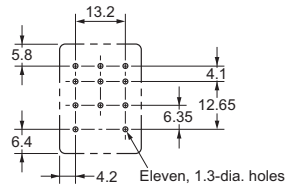

PY14-02

• This is not a flux-tight structure. We recommend manual soldering for this product.

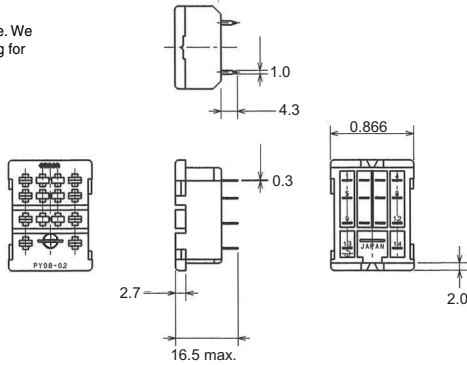

Terminal Arrangement/Internal Connection Diagram

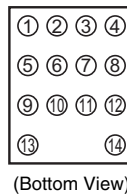

Mounting Hole and PCB Dimensions

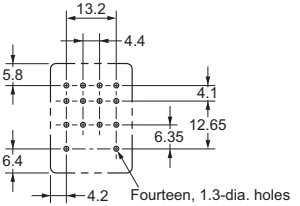

Socket Accessories

●Hold-down Clip

• PYC-A1
1 set (2 pcs.)

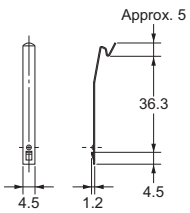

• PYC-E1
1 set (2 pcs.)

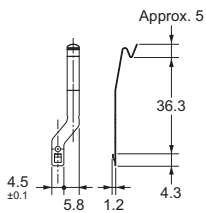

• PYC-P

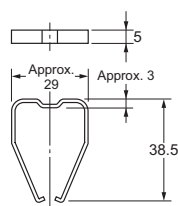

• PYC-S
1 set (2 pcs.)

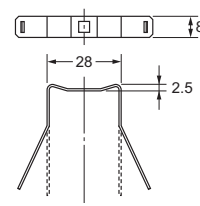

• Y92H-3
1 set (2 pcs.)

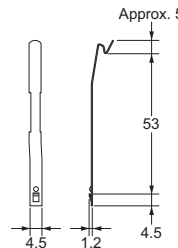

• PYC-1

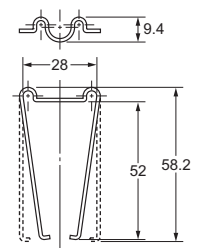

●Socket Mounting Plates

PYP-1

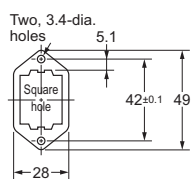

PYP-18

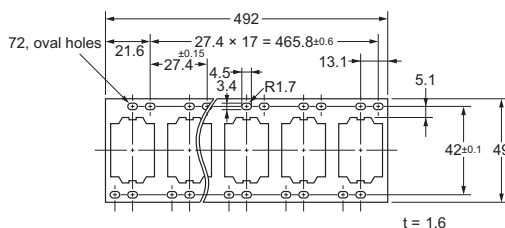

PYP-36

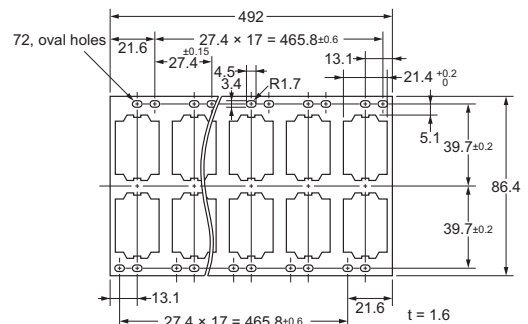

MY

MYK

MYQ-MYH

Common Options (Order Separately)

Common Precautions

● Accessories for DIN Track Mounting

DIN Tracks

PFP-100N

PFP-50N

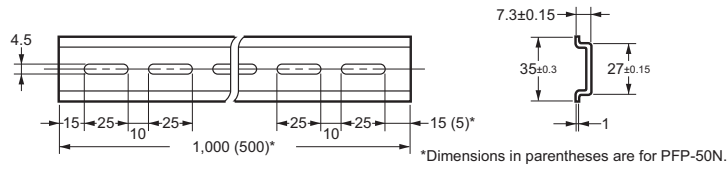
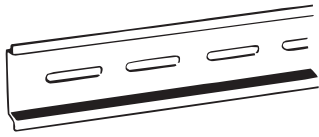

End Plate

PFP-M

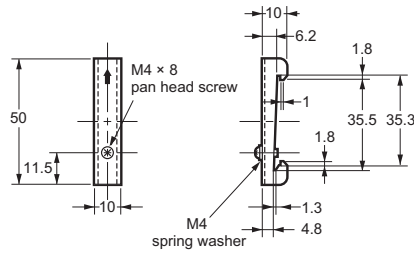

Spacer

PFP-S

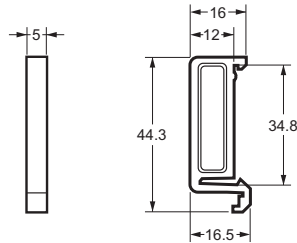
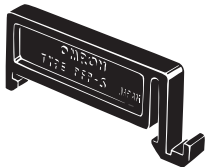

MY

MYK

MYQ-MYH

Common Options (Order Separately)



Common Precautions

Safety Precautions



Relays

Be sure to read the *Safety Precautions for All Relays* in the website at the following URL:
http://www.ia.omron.com/product/cautions/36/safety_precautions.html

Warning Indications

 WARNING	Indicates a potentially hazardous situation which, if not avoided, may result in minor or moderate injury, or may result in serious injury or death. Additionally there may be significant property damage.
 CAUTION	Indicates a potentially hazardous situation which, if not avoided, may result in minor or moderate injury or in property damage.
Precautions for Correct Use	Supplementary comments on what to do or avoid doing, to prevent failure to operate, malfunction, or undesirable effects on product performance.

Meaning of Product Safety Symbols

	<ul style="list-style-type: none"> ● General caution Indicates the possibility of non-specified general cautions, warnings, and danger.
	<ul style="list-style-type: none"> ● Electric shock caution Used to warn of the risk of electric shock under specific conditions.
	<ul style="list-style-type: none"> ● High temperature caution Indicates the possibility of injuries by high temperature under specific conditions.

 **CAUTION**

Do not touch terminal sections (i.e., current-carrying parts) while power is being supplied.

Also, always mount the terminal cover.

Touching current-carrying parts may result in electric shock.



Do not touch the main unit while power is being supplied or immediately after the power supply has been turned OFF. The main unit will be extremely hot and may result in burns.



Precautions for Correct Use

● **Handling**

For models with a built-in operation indicator, models with a built-in diode, or high-sensitivity models, check the coil polarity when wiring and wire all connections correctly (DC operation).

● **Installation**

• There is no specifically required installation orientation, but make sure that the Relays are installed so that the contacts are not subjected to vibration or shock in their movement direction.

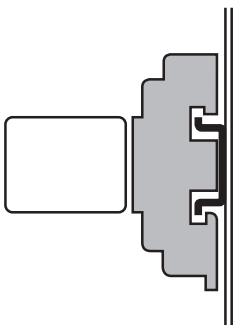

• Use two M3 screws to mount the case-surface mounting (MY□F) and tighten them securely. (Appropriate tightening torque: 0.98 N·m)

● **Relay Replacement**

To replace the Relay, turn OFF the power supply to the load and Relay coil sides to prevent unintended operation and possible electrical shock.

● **Applicable Sockets**

Use only combinations of OMRON Relays and Sockets.

● **Attaching and Removing Relay Hold-down Clips**

When you attach a Hold-down Clip to or remove it from a Socket, wear gloves or take other measures to prevent injuring your fingers on the Hold-down Clip.

● **Compliance with Electrical Appliances and Material Safety Act**

- MY standard models comply with the Electrical Appliances and Material Safety Act.
- Always protect any exposed terminals (including Socket terminals) after wiring with insulation tubes or resin coating on PCBs.

Model	Number of poles	Operating Coil ratings	Contact ratings
MY	1 2 3	6 to 220 VAC 6 to 120 VDC	5 A, 200 VAC
	4*	6 to 110 VAC 6 to 120 VDC	3 A, 115 VAC

*Under the Electrical Appliances and Material Safety Act, do not use the Type 4 model with a voltage that exceeds 150 VAC. However, this restriction can be ignored if compliance with the Electrical Appliances and Material Safety Act is not required.

● **Miniature Power Relays: MY**

Latching Levers

- Turn OFF the power supply when operating the latching lever. After you use the latching lever always return it to its original state.
- Do not use the latching lever as a switch.
- The latching lever can be used for 100 operations minimum.

About the Built-in Diode and CR Elements

The diode or CR element that are built into the Relay are designed to absorb the reverse voltage from the Relay coil. If a large surge in voltage is applied to the diode or CR element from an external source, the element will be destroyed.

If there is the possibility of large voltage surges that could be applied to the elements from an external source, take any necessary surge absorption measures.

Using Microloads with Infrequent Operation

If any standard MY-series Relays (e.g., MY4) are used infrequently to switch microloads, the contacts may become unstable and eventually result in failure contact. In this case, we recommend using the MY4Z-CBG Series, which has high contact reliability for microloads.

MY

MYK

MYQ-MYH

Common Options (Order Separately)

Common Precautions

● **Latching Relays (MYK)**

- For applications that use a 200 VAC power supply, connect external resistors R_s and R_r to a 100 VAC Relay.

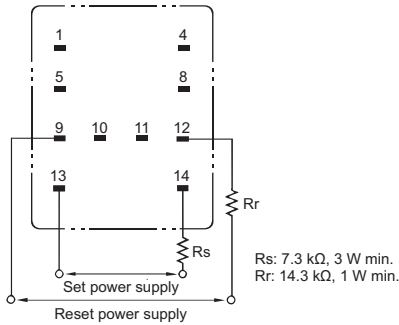

- Do not apply a voltage to the set and reset coils at the same time. If you apply the rated voltage to both coils simultaneously, the Relay will be set.
- The minimum pulse width in the performance column is the value for the following measurement conditions: an ambient temperature of 23°C with the rated operating voltage applied to the coil. Satisfactory performance may be unattainable due to decreased holding strength caused by changes in circuit conditions and ambient operating temperature, or due to changes caused by product aging. During actual use, apply a pulse width of the rated operating voltage suitable for the actual load to the coil and reset this at least once per year as a means of dealing with product aging.
- If the Relay is used in an environment with strong magnetic fields, the surrounding magnetic field can demagnetize the magnetic body and cause unintended operation. Therefore, do not use these Relays in environments with strong magnetic fields.

Optional Sockets (Order Separately)

Be sure to read the *Safety Precautions for All Relays* in the website at the following URL: http://www.ia.omron.com/product/cautions/36/safety_precautions.html

Front-connecting Sockets

● **Push-In Plus Terminal Sockets (PYF-08-PU(-L), PYF-14-PU(-L))**

Refer to *Safety Precautions* on the Push-In Plus Terminal Block Socket PYF-□□-PU/P2RF-□□-PU Data Sheet (Catalog No. SGFR-218).

● **Screwless Terminal Sockets (PYF08S, PYF14S)**

Refer to *Safety Precautions* on the Screwless Terminal Socket PYF□□S/P2RF-□□S Data Sheet (Catalog No. CDRR-011).

● **Screw Terminal Sockets (PYFZ-08(-E), PYF08M, PYF11A, PYFZ-14(-E), PYF-14T)**

Be sure to read the *Safety Precautions for All Relays*, 4-2-1 *Panel-mounting Sockets* and 4-2-2 *Relay Removal Direction* of the website at the following URL: http://www.ia.omron.com/product/cautions/36/safety_precautions.html

- Use the following tightening torque for screws during wiring.

Model	Tightening torque
PYFZ-08 PYFZ-14 PYF11A PYF14T	0.78 to 1.18 N·m
PYFZ-08-E PYFZ-14-E	0.59 to 0.88 N·m * Use a No. 1 screwdriver.

● **Hermetically Sealed Relays (MYH/MYQ)**

Relays with PCB Terminals

When a Relay with PCB Terminals is mounted, a short-circuit can occur depending on the design of the PCB pattern because the Relay itself is made out of metal.

Solution

Refer to the external dimensions of the Relay and design the PCB pattern with enough space to prevent this problem.

Application Environments

Humid environments can cause insulation problems, which may result in short-circuiting or unintended operation.

Solution

Do not use these Relays in any environment where the Relay will come into contact with water vapor, condensation, or water droplets. This can reduce the surface tension of the terminal insulating beads and cause short-circuiting or unintended operation due to insulation problem.

- Use the following wire diameters as a guide for wiring. (Select the appropriate wire diameter for the current used.)

Model	Recommended wire diameter (mm ²)	
PYFZ-08 PYFZ-14 PYF11A PYF14T	Stranded wire	0.75 to 2.5 mm ² AWG 18 to 14
	Solid wire	0.75 to 1.5 mm ² AWG 18 to 16
PYFZ-08-E PYFZ-14-E	Stranded wire	0.75 to 2.5 mm ² AWG 18 to 14
	Solid wire	0.75 to 1.5 mm ² AWG 18 to 16

Back-connecting Socket

● **Solder Terminal Sockets (PY08(-Y1/-Y3), PY11(-Y1/-Y3))**

● **Wrapping Terminals Sockets (PY08QN(-Y1/-Y3), PY08QN2(-Y1/-Y3), PY11QN(-Y1), PY11QN2(-Y1))**

● **PCB Terminal Sockets (PY08-02, PY11-02)**

Be sure to read the *Safety Precautions for All Relays*, 4-2-3 *Back-connecting Sockets* and 4-2-5 *Terminal Soldering* of the website at the following URL: http://www.ia.omron.com/product/cautions/36/safety_precautions.html

MY

MYK

MYQ-MYH

Common Options (Order Separately)

Common Precautions

MEMO

MY

MYK

MYQ-MYH

Common Options (Order Separately)

Common Precautions

Terms and Conditions Agreement

Read and understand this catalog.

Please read and understand this catalog before purchasing the products. Please consult your OMRON representative if you have any questions or comments.

Warranties.

- (a) Exclusive Warranty. Omron's exclusive warranty is that the Products will be free from defects in materials and workmanship for a period of twelve months from the date of sale by Omron (or such other period expressed in writing by Omron). Omron disclaims all other warranties, express or implied.
- (b) Limitations. OMRON MAKES NO WARRANTY OR REPRESENTATION, EXPRESS OR IMPLIED, ABOUT NON-INFRINGEMENT, MERCHANTABILITY OR FITNESS FOR A PARTICULAR PURPOSE OF THE PRODUCTS. BUYER ACKNOWLEDGES THAT IT ALONE HAS DETERMINED THAT THE PRODUCTS WILL SUITABLY MEET THE REQUIREMENTS OF THEIR INTENDED USE.

Omron further disclaims all warranties and responsibility of any type for claims or expenses based on infringement by the Products or otherwise of any intellectual property right. (c) Buyer Remedy. Omron's sole obligation hereunder shall be, at Omron's election, to (i) replace (in the form originally shipped with Buyer responsible for labor charges for removal or replacement thereof) the non-complying Product, (ii) repair the non-complying Product, or (iii) repay or credit Buyer an amount equal to the purchase price of the non-complying Product; provided that in no event shall Omron be responsible for warranty, repair, indemnity or any other claims or expenses regarding the Products unless Omron's analysis confirms that the Products were properly handled, stored, installed and maintained and not subject to contamination, abuse, misuse or inappropriate modification. Return of any Products by Buyer must be approved in writing by Omron before shipment. Omron Companies shall not be liable for the suitability or unsuitability or the results from the use of Products in combination with any electrical or electronic components, circuits, system assemblies or any other materials or substances or environments. Any advice, recommendations or information given orally or in writing, are not to be construed as an amendment or addition to the above warranty.

See <http://www.omron.com/global/> or contact your Omron representative for published information.

Limitation on Liability; Etc.

OMRON COMPANIES SHALL NOT BE LIABLE FOR SPECIAL, INDIRECT, INCIDENTAL, OR CONSEQUENTIAL DAMAGES, LOSS OF PROFITS OR PRODUCTION OR COMMERCIAL LOSS IN ANY WAY CONNECTED WITH THE PRODUCTS, WHETHER SUCH CLAIM IS BASED IN CONTRACT, WARRANTY, NEGLIGENCE OR STRICT LIABILITY.

Further, in no event shall liability of Omron Companies exceed the individual price of the Product on which liability is asserted.

Suitability of Use.

Omron Companies shall not be responsible for conformity with any standards, codes or regulations which apply to the combination of the Product in the Buyer's application or use of the Product. At Buyer's request, Omron will provide applicable third party certification documents identifying ratings and limitations of use which apply to the Product. This information by itself is not sufficient for a complete determination of the suitability of the Product in combination with the end product, machine, system, or other application or use. Buyer shall be solely responsible for determining appropriateness of the particular Product with respect to Buyer's application, product or system. Buyer shall take application responsibility in all cases.

NEVER USE THE PRODUCT FOR AN APPLICATION INVOLVING SERIOUS RISK TO LIFE OR PROPERTY OR IN LARGE QUANTITIES WITHOUT ENSURING THAT THE SYSTEM AS A WHOLE HAS BEEN DESIGNED TO ADDRESS THE RISKS, AND THAT THE OMRON PRODUCT(S) IS PROPERLY RATED AND INSTALLED FOR THE INTENDED USE WITHIN THE OVERALL EQUIPMENT OR SYSTEM.

Programmable Products.

Omron Companies shall not be responsible for the user's programming of a programmable Product, or any consequence thereof.

Performance Data.

Data presented in Omron Company websites, catalogs and other materials is provided as a guide for the user in determining suitability and does not constitute a warranty. It may represent the result of Omron's test conditions, and the user must correlate it to actual application requirements. Actual performance is subject to the Omron's Warranty and Limitations of Liability.

Change in Specifications.

Product specifications and accessories may be changed at any time based on improvements and other reasons. It is our practice to change part numbers when published ratings or features are changed, or when significant construction changes are made. However, some specifications of the Product may be changed without any notice. When in doubt, special part numbers may be assigned to fix or establish key specifications for your application. Please consult with your Omron's representative at any time to confirm actual specifications of purchased Product.

Errors and Omissions.

Information presented by Omron Companies has been checked and is believed to be accurate; however, no responsibility is assumed for clerical, typographical or proofreading errors or omissions.

OMRON Corporation Industrial Automation Company
Kyoto, JAPAN

Contact: www.ia.omron.com

Authorized Distributor:

© OMRON Corporation 2018-2021 All Rights Reserved.
In the interest of product improvement,
specifications are subject to change without notice.

CSM_10_12
Cat. No. J219-E1-11

1121 (0618) (O)