

M12 male 90° / M12 female 0° DeviceNet

PUR AWG24+AWG22 shielded vt UL/CSA+drag ch. 0,2m

DeviceNet, CANopen
 Male 90° to female straight
 M12 - M12
 5-pole, shielded

Plastic housings with good resistance against chemicals and oils. The resistance to aggressive media should be individually tested for your application. Further details on request. Further cable lengths on request.

[Link to Product](#)

Illustration

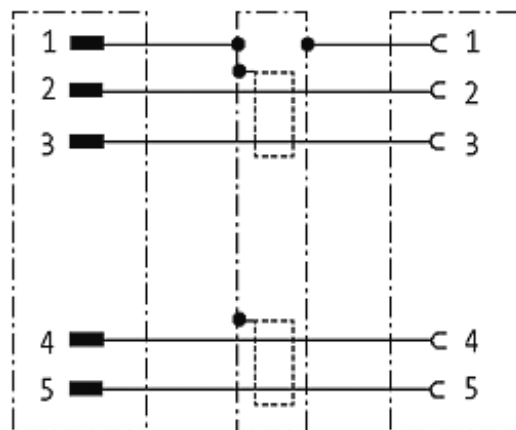
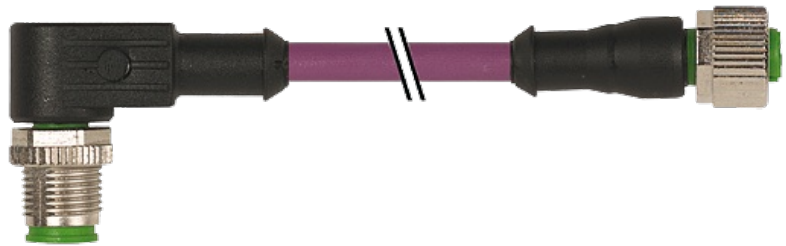

Male

Female

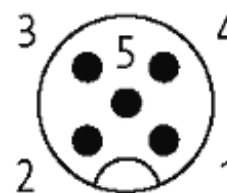
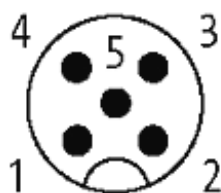

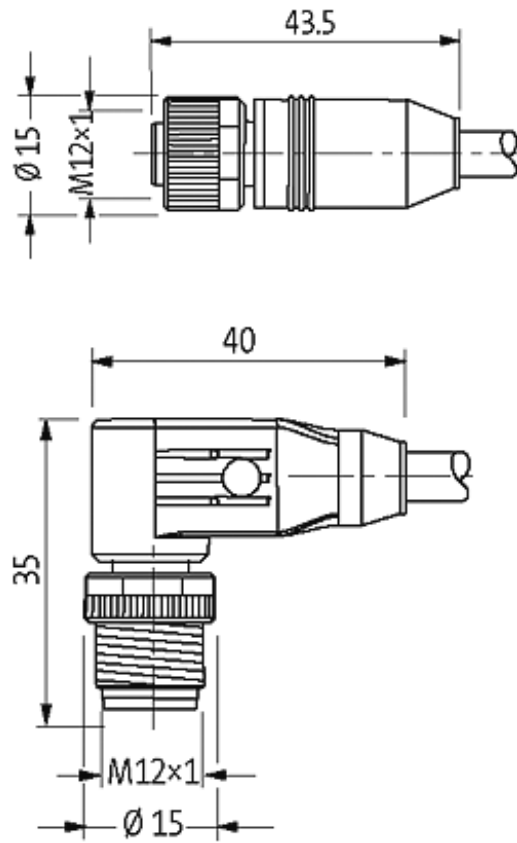

Product may differ from Image