

LED-INDICATOR RED/GREEN

LED 5mm - 24V DC - 15mA - IP40

(red/green)

24 V DC

Protection IP40

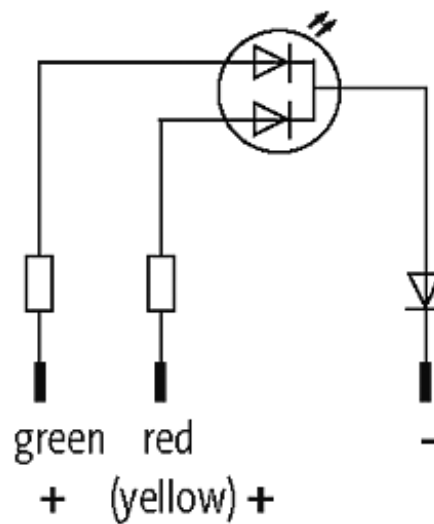
[Link to Product](#)**Illustration**

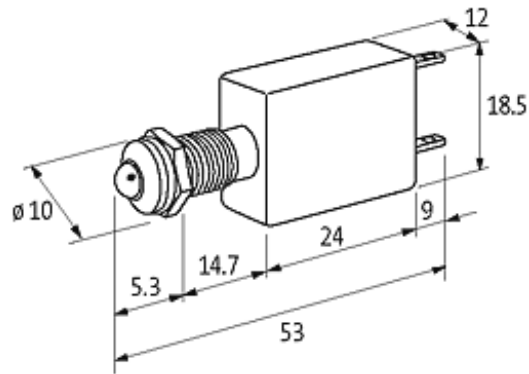

Product may differ from Image

Technical Data

Operating voltage	24 V DC $\pm 15\%$
Current consumption	15 ± 2 mA
Protection acc. to (IEC 60529/EN 60529)	IP40

General data

Housing	Adapter – PVC, gray
LED \varnothing	5 mm
Front panel hole diameter \varnothing	8 mm
Dimensions H \times W \times D	18.5 \times 12 \times 53 mm
Connection	Faston 2.8 \times 0.8 mm
Temperature range	-40...+70 °C

Commercial data

country of origin	DE
customs tariff number	85414010
minimum order quantity	10