

PRODUKTDATENBLATT

POLO-KAL NG Abzweig 50/40/67

Artikel-Nr. 02213

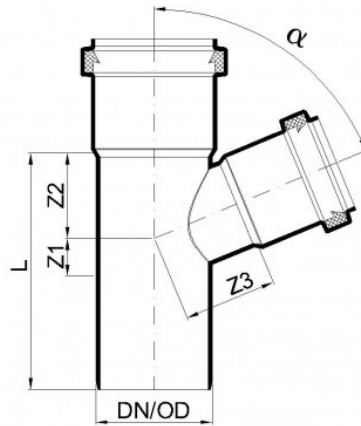
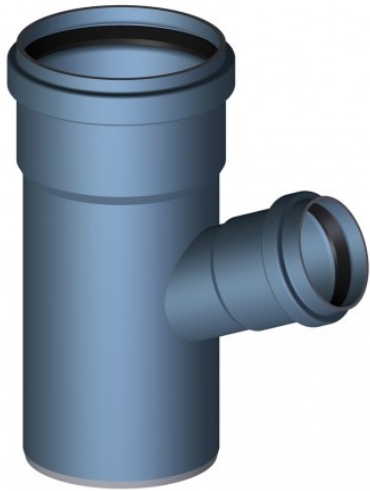

PURE
PROGRESS / poloplast

Technische Daten

DN/OD	50
DN/OD2	40
Winkel α	67,5°
Länge L	101 mm
Z1	16 mm
Z2	36 mm
Z3	40 mm
Gewicht	0,09 kg/Stk.
Verpackungseinheit	10 Stk.