

## Rubber Metal Buffers

25150.0041



### Product Description

To be used for elastic bearing of motors, compressors, pumps etc.  
The hardness is  $55 \pm 5^\circ$  shore A. Further shore hardnesses ( $40 \pm 5^\circ$  shore A and  $70 \pm 5^\circ$  shore A) on request.

### Material

#### Support washer

- Steel, zinc-plated, blue chromated

#### Threaded bushing

- Steel, zinc-plated, blue chromated

#### Body

- Rubber natural caoutchouc (NR), black

#### Screw

- Steel, zinc-plated, blue chromated

### Drawing

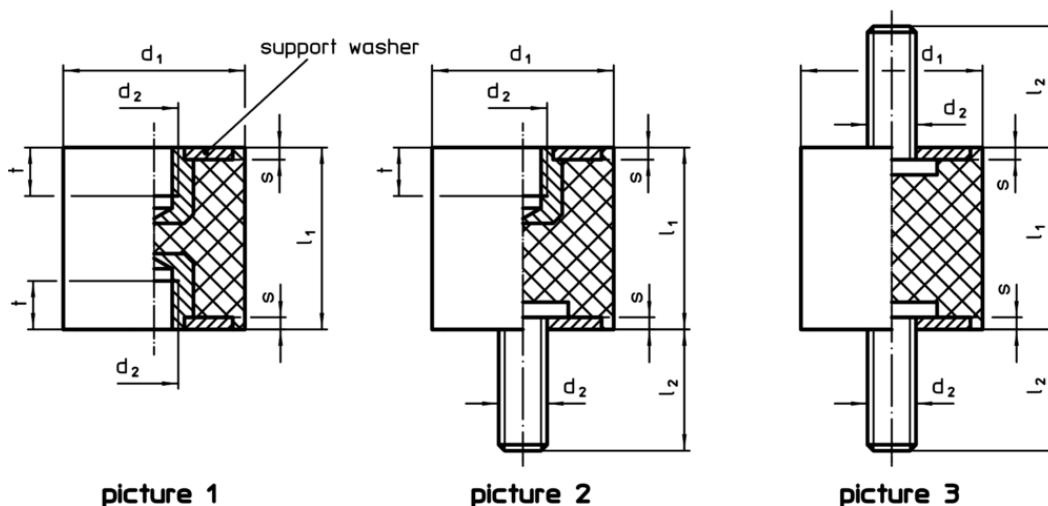

### Order information

Dimensions					Spring rate R	Load capacity max.	Spring range	Temperature range		Weight	Art. No.
$d_1$	$l_1$	$d_2$	$s$	$t$	~		~	min.	max.	[g]	
$\pm 1.5$	$\pm 1.5$			min.	[N/mm]	[N]	[mm]	[°C]			
with female thread, on both sides – picture 1											
40	30	M8	2	6.5	205	1535	7.5	-30	80	80	25150.0041

### Application example

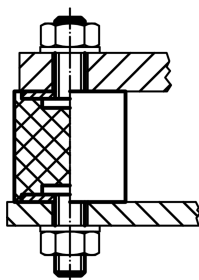



## Compliance

### RoHS compliant

Contains lead - compliant according to exceptions 6a / 6b / 6c

### Contains SVHC substances >0,1% w/w

Contains lead - SVHC list [REACH] as of 10.06.2022

### Contains Proposition 65 substances



Lead can cause cancer and reproductive harm from exposure  
<https://www.P65Warnings.ca.gov/>

### Free from Conflict Minerals

This product does not contain any substances designated as "conflict minerals" such as tantalum, tin, gold or tungsten from the Democratic Republic of Congo or adjacent countries.