

Desktop Power Supply Unit



Features

- IEC/EN/UL 62368-1 & 60950-1
- 100-240 VAC Universal Input, Without Any Slide Switch
- Regulated Output With Low Ripple Noise
- Safety Agency Requirements and EMI/EMS Certified
- CEC, DoE Level VI, Energy Star, ErP Stage 2, CoC Tier 2, NRCAN & GEMS Level VI
- No Load Power Consumption Less Than 0.15 W



Input Specification

Voltage	Universal 100 ... 240 VAC, Single Phase
Frequency	50 ... 60 Hz
Current	1.4 A max.
Inrush Current	80 A max. / 240 VAC Cold Start @ 25 °C, Full Load
Efficiency	88 % @ 115 & 230 VAC
Power Consumption	210 mW @ 230 VAC & No Load
Protection	Internal Primary Current Fuse
Configuration	IEC60320 C8

Output Specification

Voltage	12 V \pm 5%
Current	5 A max.
Regulation	11.4 V min. / 12 V typ. / 12.6 V max.
Ripple & Noise	120 mV max.
Total Power	60 W max.
Load Regulation	\pm 5% (Typ.)
Transient Response	0.5 ms for 50% Load Change Typ.
Hold-Up Time	10 ms @ Full Load
Configuration	2.1 x 5.5 mm Barrel Plug
DC Cord	16 AWG

Safety

Insulation Resistance	10 MOhm for 500 VDC (Primary to Secondary)
EMI Requirement	CE Class B, Conduction and Radiation Met
Approvals	CB / UL / cUL / FCC / GS / CE / PSE / BSMI / CCC / RCM / LPS
Over Voltage Protection (OVP)	V out * 150% (max.)
Short Circuit Protection (SCP)	Automatic recovery after short-circuit fault being removed
Over Current Protection (OCP)	I out * 180% (max.)

Notes

When short circuit protection or over current protection is activated, the power supply will shutdown automatically
Once the abnormal condition resulting in the failure is removed, the power supply will restart accordingly
When over voltage protection is activated, the power supply will shutdown

Electrical

Topology	Switching Flyback
Dielectric Withstand	3 kVAC Primary - Secondary
Leakage Current	0.25 mA
Efficiency	DoE Level VI, Energy Star, ErP Stage 2, CoC Tier 2, NRCAN & GEMS Level VI Certified
EMC Standards	EN55032 / EN61000-3-2,3 / EN55024
MTBF	300000 Calculated Hours at 25 °C

Desktop Power Supply Unit



Operation and Environment Performance

Operating Temperature	0 ... 40 °C
Storage Temperature	-20 ... 80 °C
Operating Humidity	20 ... 80% RH
Storage Humidity	10 ... 90% RH
Cooling	Natural Convection Cooling

Mechanical Specification

Cable Type	16 AWG, UL1185 Wire
Plug Type	∅ 5.5 * ∅ 2.1 * 9.5 mm
Cable Length	1.5 m
Case Dimensions (L*W*H)	115 x 53 x 38 mm
Material Flammability	UL94V-0
Weight	310 g, Typical

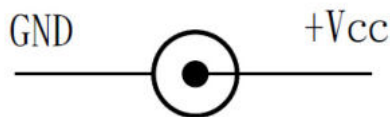

Cable & Plug Drawing

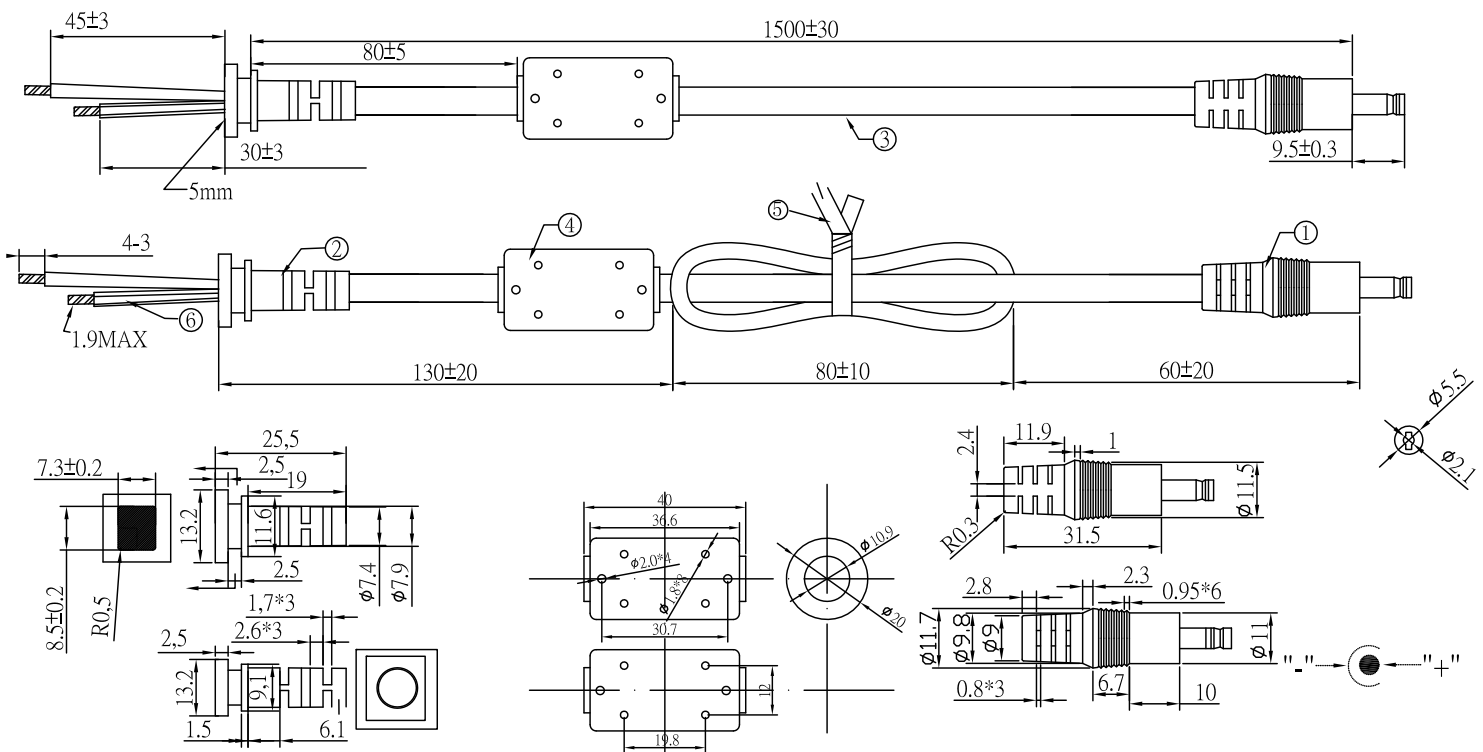

Desktop Power Supply Unit



Adapter Drawing

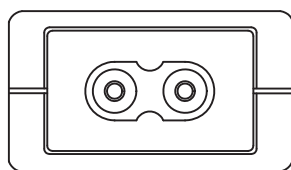
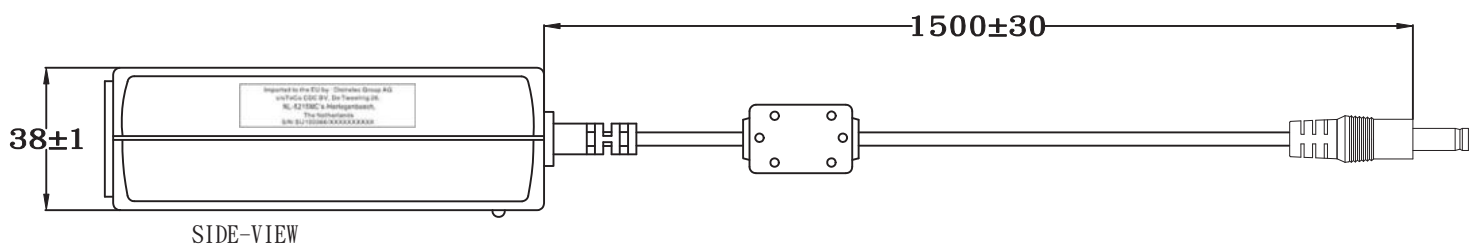
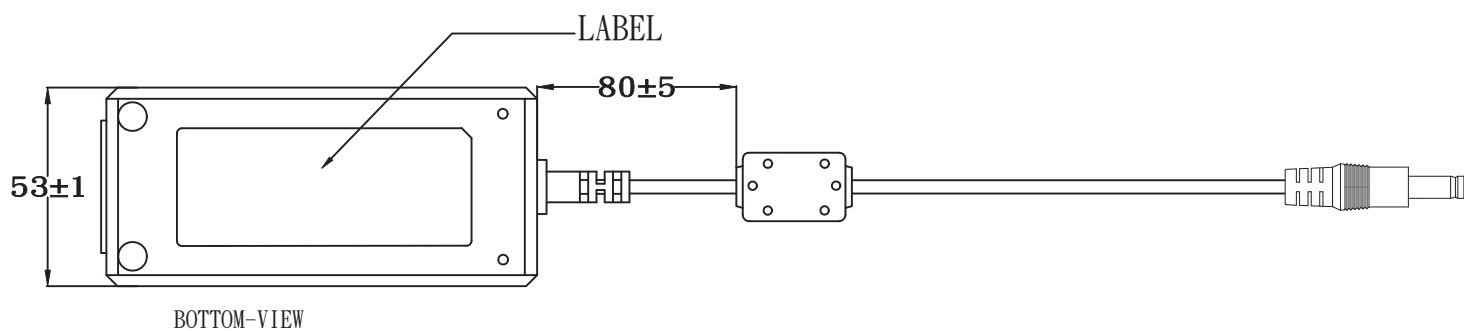
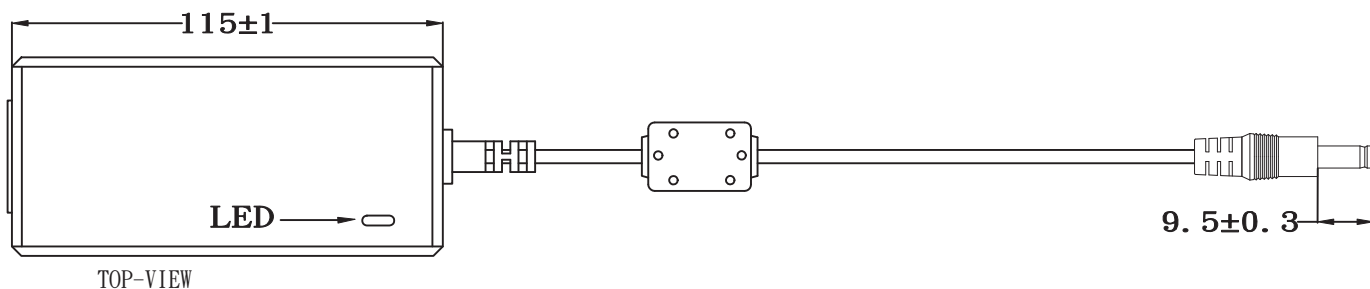

FRONT-VIEW

AC Adapter



Derating Curve

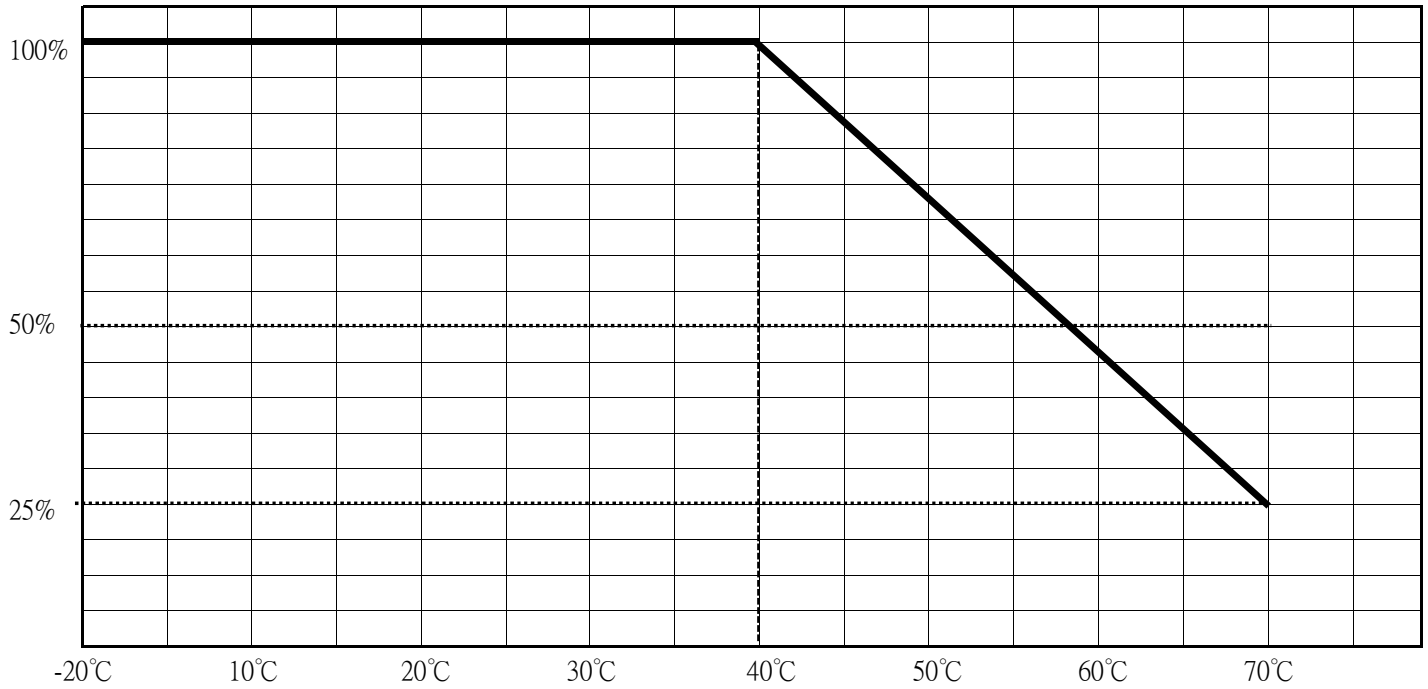

Static Characteristics

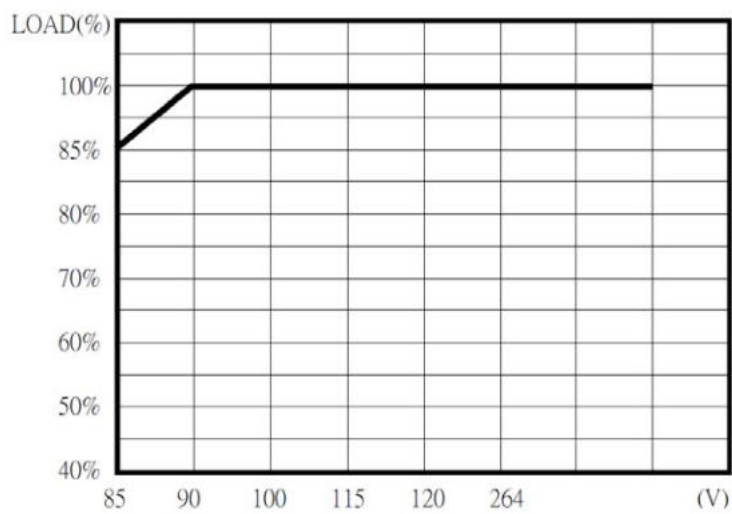

Art Nr.
RND 320-00085