

MIXED SYSTEM



For heavy applications
Fast commutation
Large number of cycles
High flow rate



AC 7

G1/8



1080
NI/min

AC 8

G1/4



1600
NI/min

AC 9

G1/2



4600
NI/min

Angle plate for "H"
solenoid option



Angle plate for "P"
solenoid option



Plate for external pilot
supply











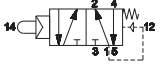

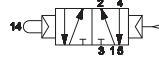
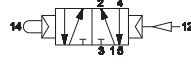







CHARACTERISTICS



Ambient temperature	-10 ÷ +45 °C		
Fluid	50 µm filtered air, with or without lubrication		
Commutation system	poppet mixed system		
Max pressure	10 bar		
Connections	G1/8	G1/4	G1/2
Nominal bore (mm)	6	8	15
Nominal flow rate (NI/min)	1080	1600	4600
Valve body	zamak	zamak	die-cast aluminium
Seals	NBR, polyurethane		
Spool	aluminium		
Electropilot	U1	U1	U2
Coil	DA	DA	DB
Power consumption	3,5 W (DC) - 5 VA (AC)	3,5 W (DC) - 5 VA (AC)	11 W (DC) - 10 VA (AC)
Connector	AM-5110	AM-5110	AM-5111
Voltage	12 V DC - 24 V DC - 24 V AC - 110 V AC - 230 V AC		
Manual override	impulse screw - 2 positions		



Indirect mechanical operation

<p>■ Preset for pneumatic, mechanical and manual operators</p>   <p>AC-7010 G1/8 AC-8010 G1/4 AC-9010 G1/2</p>								<p>■ Preset for panel operators Ø22</p>   <p>AC-7013 G1/8 AC-8013 G1/4 AC-9013 G1/2</p>   <p>AC-7013P G1/8 AC-8013P G1/4 AC-9013P G1/2</p>							
															
AI-3550	AI-3551	AI-3560	AI-3562	AI-3563	AI-3570	AI-3571	AI-3572	AI-3511Q	AI-3514Q	AI-3515Q	AI-3520Q	AI-3522Q	AI-3524Q	AI-3525Q	AI-3526Q
AI-3512	AI-3514	AI-3515	AI-3520	AI-3522	AI-3524	AI-3525	AI-3526	AI-3512Q	AI-3516Q	AI-3517Q	AI-3521Q	AI-3523Q			
AI-3513	AI-3514D	AI-3519						AI-3513Q	AI-3514QD	AI-3519Q					
	AI-3516D							AI-3516QD							

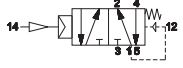
Pneumatic impulse

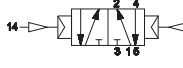
<p>■ Single impulse</p>   <p>AC-7100 G1/8 AC-8100 G1/4 AC-9100 G1/2</p>								<p>■ Double impulse</p>   <p>AC-7120 G1/8 AC-8120 G1/4 AC-9120 G1/2</p>							
---	--	--	--	--	--	--	--	--	--	--	--	--	--	--	--

Electrical impulse

■ Single impulse

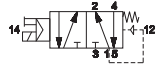

AC-7500 G1/8
 AC-8500 G1/4
 AC-9500 G1/2

■ Double impulse

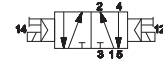

AC-7520 G1/8
 AC-8520 G1/4
 AC-9520 G1/2

Solenoid valves are supplied without coil/connector/locking nut

Modular sub-base

■ G1/8



AC-7900

AC-7905

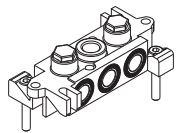

Sub-base with connections
 G1/8

5/2 MIXED system inlet
 plate - G1/8

■ G1/4



AC-8900

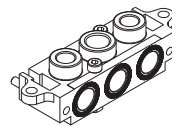

Sub-base with threaded
 connections G1/4

Sub-bases are supplied with fixing screws

AM-5148

AM-5151

AM-5152

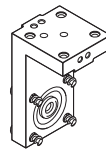
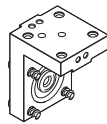
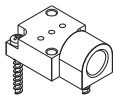

plate for external pilot supply
 G1/8 - G1/4

Angle plate for "H" solenoid
 option G1/8 - G1/4

Angle plate for "P" solenoid
 option G1/8 - G1/4

AC

MIXED threaded valves G1/8 - G 1/4 - G1/2

- Mixed commutation system (spool - poppet)
- High flow rate
- Quick response time
- High cycles
- Control: manual, mechanical, pneumatic, electric
- Modular sub-bases



TECHNICAL CHARACTERISTICS

Ambient temperature	-10 ÷ +45 °C		
Fluid temperature	max +50 °C		
Fluid	filtered air 50 µm, lubricated or not		
Commutation system	poppet mixed system		
Ways/Positions	5/2		
Pressure	10 bar max		
Control	pneumatic, electric, mechanical		
Return	pneumomechanical spring, pneumatic, electric		
Connections	G1/8	G1/4	G1/2
Nominal Ø (mm)	6	8	15
Nominal flow rate (NI/min)	1080	1600	4600

CONSTRUCTIVE CHARACTERISTICS

Valve body	G1/8 - G1/4 = zamak
	G1/2 = die-cast aluminium
Seals	nitrile rubber, polyurethane
Actuators	technopolymer
Spool	aluminium

ELECTRIC CHARACTERISTICS

	G1/8	G1/4	G1/2
Electropilot	U1		U2
Coil	DA		DB
Power consumption	3,5 W (DC) - 5 VA (AC)		11 W (DC) - 10 VA (AC)
Connector	AM-5110		AM-5111
Voltage	12 V DC - 24 V DC - 24 V AC - 110 V AC - 230 V AC		
Manual override	with 2 position screw		

Flow rate characteristics

>> G1/8

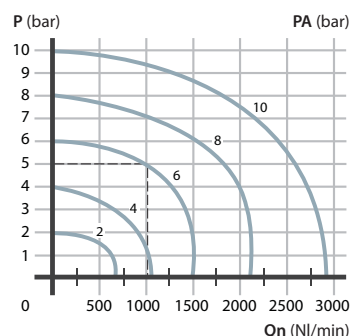

>> G1/4

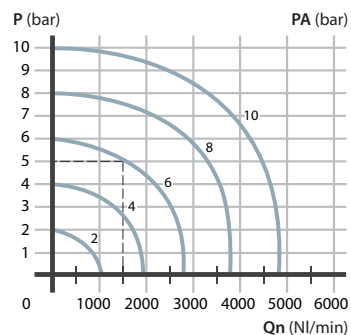

>> G1/2

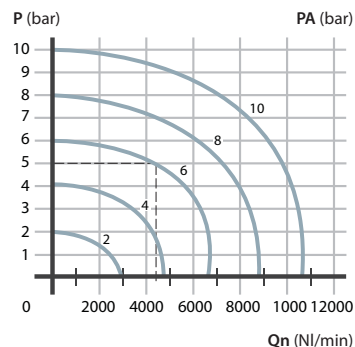

P = Working pressure
 PA = Supply pressure
 Qn = Flow rate

Indirect mechanical control for use with pneumatic, mechanical and manual actuators



1 = Supply port
2 - 4 = Use
3 - 5 = Exhaust
14 = Control
12 = Return

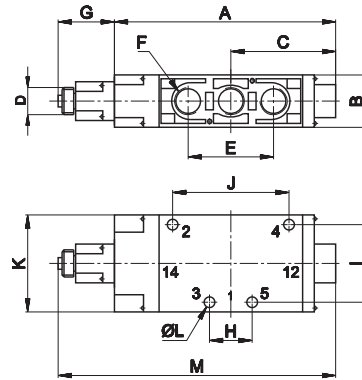

	G1/8	G1/4	G1/2
A	99	114	163
B	25	27	40
C	47	54	83
D	M14x1	M14x1	M14x1
E	36	44	80
F	G1/8	G1/4	G1/2
G	27	27	27
H	18	22	40
I	26	40	50
J	36	60	108
K	40	50	63
L	4,5	5,5	6,5
M	126	141	190

5/2

Symbol	Connection	Control	Return	Pressure bar	Weight Kg	Part no.
	G1/8			1,8÷10	0,27	AC-7010
	G1/4	ball pushrod	pneumomechanical spring	2,3÷10	0,28	AC-8010
	G1/2			2÷10	0,33	AC-9010

MANUAL ACTUATORS

	Recessed button	<ul style="list-style-type: none"> BLACK AI-3511 RED AI-3512 GREEN AI-3513 	
	Head button	<ul style="list-style-type: none"> RED AI-3514 BLACK AI-3516 RED AI-3514D BLACK AI-3516D 	
	Button	<ul style="list-style-type: none"> GREEN AI-3515 RED AI-3517 BLACK AI-3519 	
	Rotating selector	<ul style="list-style-type: none"> BLACK AI-3520 BLACK AI-3521 	
	Rotating lever selector	<ul style="list-style-type: none"> BLACK AI-3522 BLACK AI-3523 	
	Lever operator	<ul style="list-style-type: none"> BLACK AI-3524 	
	Omni-directional operator	<ul style="list-style-type: none"> BLACK AI-3525 	
	Push-pull operator	<ul style="list-style-type: none"> BLACK AI-3526 	

PNEUMATIC AND MECHANICAL ACTUATORS

	Pneumatic actuator	AI-3550	
	Amplified pneumatic actuator	AI-3551	
	Roller operator 1 position	AI-3560	
	Ball-push operator 1 position	AI-3562	
	Operator with omni-directional antenna 1 position	AI-3563	
	Roller lever operator 1 position	AI-3570	
	Articulated roller lever operator 1 position Complete actuation with stroke 2,5 mm, max stroke 4,7 mm	AI-3571	
	Key operator 1 position	AI-3572	

For actuator dimensions refer to section "Accessories > Actuators and buttons"

Indirect control
for panel mounting actuators Ø 22

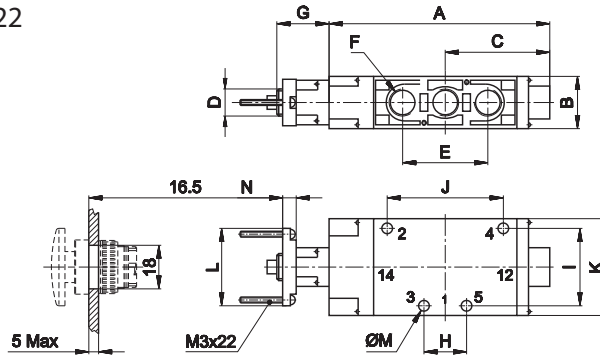

1 = Supply port
2 - 4 = Use
3 - 5 = Exhaust
14 = Control
12 = Return

	G1/8	G1/4	G1/2
A	99	114	163
B	25	27	40
C	47	54	83
D	M14x1	M14x1	M14x1
E	36	44	80
F	G1/8	G1/4	G1/2
G	27	27	27
H	18	22	40
I	26	40	50
J	36	60	108
K	40	50	63
L	40	40	40
M	4,5	5,5	6,5
N	7	7	7

	Symbol	Connection	Control	Return	Pressure bar	Weight Kg	Part no.
5/2		G1/8	ball pushrod	pneumomechanical spring	1,8÷10	0,28	AC-7013
		G1/4			2,3÷10	0,29	AC-8013
		G1/2			2÷10	0,84	AC-9013
5/2		G1/8	ball pushrod	pneumatic amplified	1÷10	0,29	AC-7013P
		G1/4			1÷10	0,28	AC-8013P
		G1/2			1÷10	0,83	AC-9013P

MANUAL ACTUATORS

	Recessed button	<ul style="list-style-type: none"> ■ BLACK AI-3511 ■ RED AI-3512 ■ GREEN AI-3513 	
	Head button	<ul style="list-style-type: none"> ■ RED AI-3514 ■ BLACK AI-3516 ■ RED AI-3514D ■ BLACK AI-3516D 	
	Button	<ul style="list-style-type: none"> ■ GREEN AI-3515 ■ RED AI-3517 ■ BLACK AI-3519 	
	Rotating selector	<ul style="list-style-type: none"> ■ BLACK AI-3520 ■ BLACK AI-3521 	
	Rotating lever selector	<ul style="list-style-type: none"> ■ BLACK AI-3522 ■ BLACK AI-3523 	
	Lever operator	<ul style="list-style-type: none"> ■ BLACK AI-3524 	
	Omni-directional operator	<ul style="list-style-type: none"> ■ BLACK AI-3525 	
	Push-pull operator	<ul style="list-style-type: none"> ■ BLACK AI-3526 	

For actuator dimensions refer to section "Accessories>Actuators and buttons"

Single/double **pneumatic impulse**



Symbol	Connection	Control	Return	Pressure bar	Times (ms)		Weight Kg	Part no.	
					En.	De-en.			
SINGLE PNEUMATIC IMPULSE									
5/2		G1/8	pneumatic amplified	pneumomechanical	1,8÷10	8	10	0,22	AC-7100
		G1/4			2,3÷10	10	10	0,23	AC-8100
		G1/2			2÷10	10	10	0,76	AC-9100
DOUBLE PNEUMATIC IMPULSE									
5/2		G1/8	pneumatic amplified	pneumatic amplified	1÷10	5	10	0,23	AC-7120
		G1/4			0,8÷10	6	6	0,21	AC-8120
		G1/2			0,8÷10	8	8	0,77	AC-9120

Single pneumatic impulse

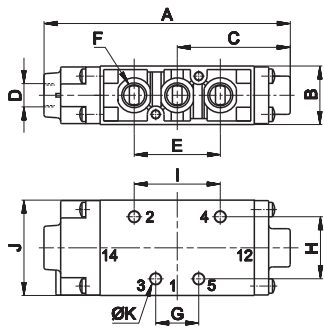

- 1 = Supply port
- 2 - 4 = Use
- 3 - 5 = Exhaust
- 14 = Control
- 12 = Return

	A	B	C	D	E	F	G	H	I	J	K
G1/8	103	25	47	G1/8	36	G1/8	18	26	36	40	4,5
G1/4	117	27	54	G1/8	44	G1/4	22	40	60	50	5,5
G1/2	165	40	82,5	G1/8	80	G1/2	40	50	108	63	6,5

Double pneumatic impulse

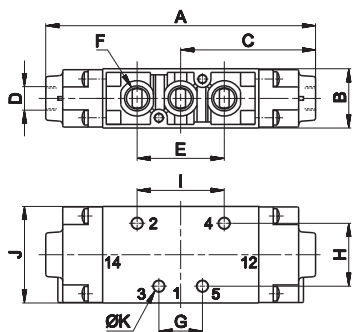

- 1 = Supply port
- 2 - 4 = Use
- 3 - 5 = Exhaust
- 14 = Control
- 12 = Return

	A	B	C	D	E	F	G	H	I	J	K
G1/8	112	25	56	G1/8	36	G1/8	18	26	36	40	4,5
G1/4	126,5	25	63	G1/8	44	G1/4	22	40	60	50	5,5
G1/2	165	40	82,5	G1/8	80	G1/2	40	50	108	63	6,5

Single/double electric impulse



Symbol	Connection	Control	Return	Pressure bar	Times (ms)		Weight Kg	Part no.	
					En.	De-en.			
SINGLE ELECTRIC IMPULSE									
5/2		G1/8			1,8÷10	18	20	0,27	AC-7500
		G1/4	electric amplified	pneumomechanical	2,3÷10	22	22	0,28	AC-8500
		G1/2			2÷10	23	30	1,1	AC-9500
DOUBLE ELECTRIC IMPULSE									
5/2		G1/8			1÷10	14	14	0,33	AC-7520
		G1/4	electric amplified	electric amplified	0,8÷10	14	14	0,31	AC-8520
		G1/2			0,8÷10	16	16	1,1	AC-9520

Single electric impulse

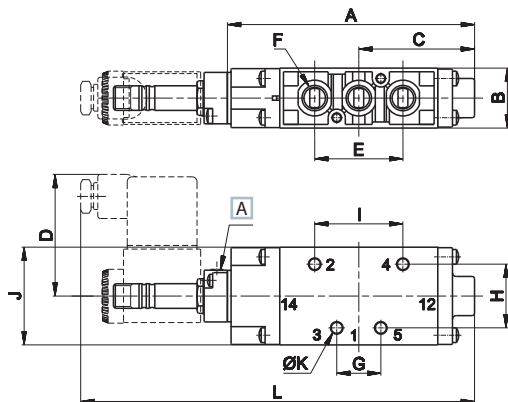

A Manual override

- 1 = Supply port
- 2 - 4 = Use
- 3 - 5 = Exhaust
- 14 = Control
- 12 = Return

	A	B	C	D	E	F	G	H	I	J	K	L
G1/8	101	25	47	50	36	G1/8	18	26	36	40	4,5	164
G1/4	116	27	54	50	44	G1/4	22	40	60	50	5,5	180
G1/2	165	40	83	48	80	G1/2	40	50	108	63	6,5	241

Double electric impulse

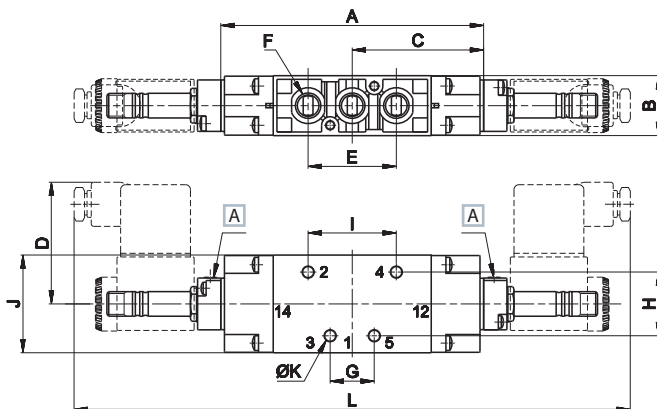

A Manual override

- 1 = Supply port
- 2 - 4 = Use
- 3 - 5 = Exhaust
- 14 = Control
- 12 = Return

	A	B	C	D	E	F	G	H	I	J	K	L
G1/8	107	25	53,5	50	36	G1/8	18	26	36	40	4,5	227
G1/4	124	27	62	50	44	G1/4	22	40	60	50	5,5	252
G1/2	164	40	80,5	48	80	G1/2	40	50	108	63	6,5	317

For technical data of coils, refer to section "Accessories>Coils"
 For external servoassisted pilot, use AM - 5148 plates (refer to next pages)
 Electrovalves are supplied without coil, connector and locking ring

Modular sub-base G1/8

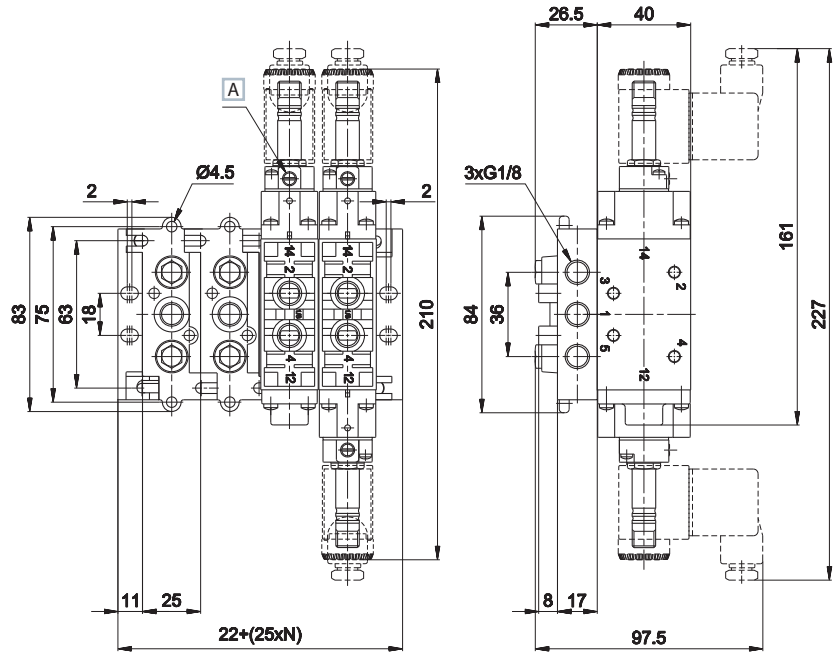

A Manual override

- 1 = Supply port
- 2 - 4 = Use
- 3 - 5 = Exhaust
- 14 = Control
- 12 = Return

AC-7900

AC-7905

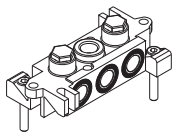

Sub-base with connections
G1/8
weight: 0,15 Kg

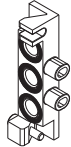

Inlet plate MIXED
system 5/2 - G1/8
weight: 0,06 Kg

Modular sub-base G1/4

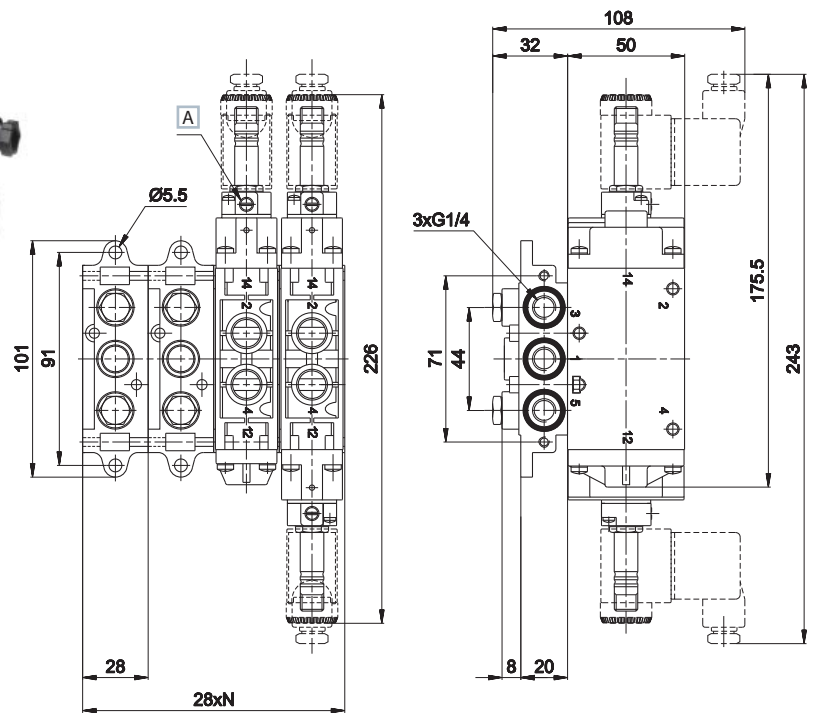

A Manual override

- 1 = Supply port
- 2 - 4 = Use
- 3 - 5 = Exhaust
- 14 = Control
- 12 = Return

AC-8900

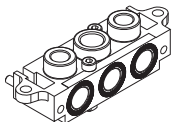

Sub-base with threaded
connections G1/4
Screws are supplied
separately
weight: 0,22 Kg

AM-5148

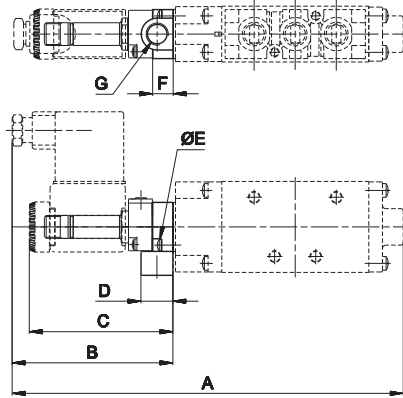
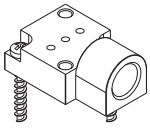

	G1/8	G1/4
A	171,5	186
B	70,5	70,5
C	63	63
D	14	14
E	2,9x10	2,9x10
F	9	9
G	G1/8	G1/8

Plate for external servoassisted pilot
weight: 0,03 Kg

AM-5151

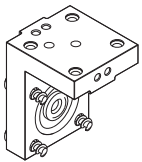

AM-5151 + AM-5148

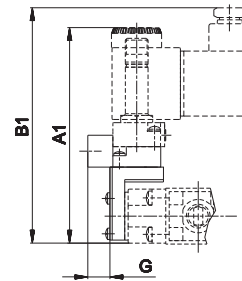
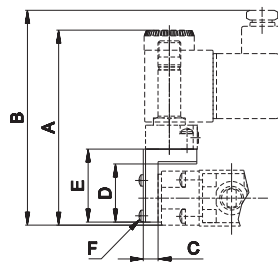

	G1/8	G1/4
A	87,7	88,7
A1	96,7	97,7
B	95,5	96,5
B1	104,5	105,5
C	6,5	6,5
D	25,5	25,5
E	32	32
F	2,9x10	2,9x10
G	9,7	9,7

"H" option solenoid square
weight: 0,035 Kg

AM-5152

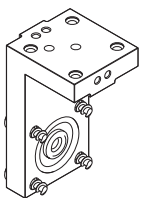

AM-5152 + AM-5148

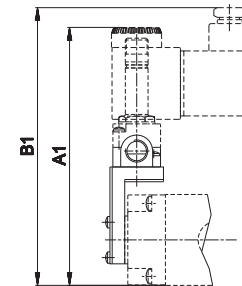
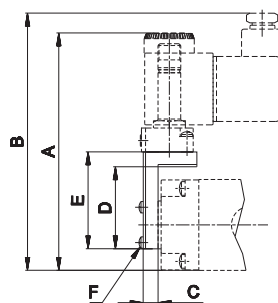

	G1/8	G1/4
A	106	111
A1	115	120
B	113,5	118,5
B1	122,5	127,5
C	6,5	6,5
D	36	36
E	42,5	42,5
F	2,9x10	2,9x10

"P" option solenoid square
weight: 0,05 Kg