

Studs • DIN 6379 for T-nuts 23040.0362



Product Description

Studs combined with T-nuts DIN 508 (EH 23010./23020.), fixture nuts DIN 6330 (EH 23070.) and plain washers DIN 6340 (EH 23060.) become complete clamping studs. These studs are characterised by the rolled thread.

Material

- Heat-treated steel

More information

References

For torques and strengths please refer to appendix - Technical Data - Studs with elongated dimension b_1 also available.

Further products

- Nuts for T-Slots, DIN 508
- Studs, DIN 6379 b_1 long for nut for T-Slots
- Studs, with internal hexagon, similar to DIN 6379, for nuts for T-Slots
- Shaft / Plain Washers, DIN 6340 heat-treated
- Fixture Nuts, DIN 6330 (height 1,5 d)

Drawing

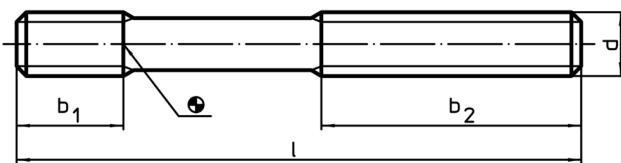

Order information

d	Dimensions			[g]	Art. No.
	l	b_1	b_2		
quality 8.8					
M36	250	51	160	1674	23040.0362

Application example



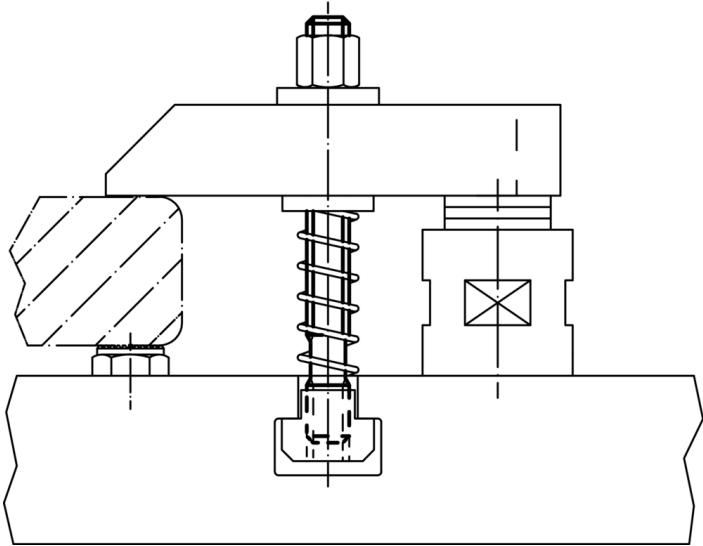

Compliance

RoHS compliant

Compliant according to Directive 2011/65/EU and Directive 2015/863

Does not contain SVHC substances

No SVHC substances with more than 0.1% w/w contained - SVHC list [REACH] as of 10.06.2022

Does not contain Proposition 65 substances

No Proposition 65 substances included

<https://www.P65Warnings.ca.gov/>

Free from Conflict Minerals

This product does not contain any substances designated as "conflict minerals" such as tantalum, tin, gold or tungsten from the Democratic Republic of Congo or adjacent countries.