

92mm sq.

San Ace 92

25mm thick (9GA type), 25mm thick (9S type)
 25mm thick (9P type), 25mm thick (San Cooler) (9A type)
 32mm thick (9G type), 38mm thick (9GA type)
 38mm thick (9HV type), 38mm thick (9GV type)
 38mm thick (9G type)



General Specifications

- Material Frame: Plastics (Flammability: UL94V-0),
Impeller: Plastics (Flammability: UL94V-0)
- Expected Life Refer to specifications (L10:Survival rate:90% at 60°C ,
rated voltage, and continuously run in a free air state)
- Lead Wire ⊕red ⊖black (Sensor) yellow (Control) brown
- Storage Temperature -30°C to +70°C (Non-condensing)

92×92×25mm (Mass : 125g) **9GA type** **Low Power Consumption Fan**

Specifications

The following nos. **have PWM controls, pulse sensors, and ribs.** For ribless, append "1" to the model no.

Model No.	Rated Voltage [V]	Operating Voltage Range [V]	PWM duty cycle※ [%]	Rated Current [A]	Rated Input [W]	Rated Speed [min ⁻¹]	Max. Airflow [m ³ /min] [CFM]	Max. Static Pressure [Pa] [inchH ₂ O]	SPL [dB(A)]	Operating Temperature [°C]	Expected Life [h]
9GA0912P4J03	12	10.2 to 13.8	100	0.39	4.68	5,000	2.20 77.7	105 0.42	43	-20 to +70	60,000
			0	0.06	0.72	1,500	0.66 23.3	9.5 0.04	14		
9GA0912P4G03			100	0.28	3.36	4,400	1.93 68.2	81 0.33	39		
			0	0.06	0.72	1,500	0.66 23.3	9.5 0.04	14		
9GA0912P4S03			100	0.2	2.4	3,800	1.67 59.0	60.6 0.24	35		
			0	0.06	0.72	1,500	0.66 23.3	9.5 0.04	14		
9GA0924P4J03	24	20.4 to 27.6	100	0.2	4.80	5,000	2.20 77.7	105 0.42	43		
			0	0.04	0.96	1,500	0.66 23.3	9.5 0.04	14		
9GA0924P4G03			100	0.15	3.60	4,400	1.93 68.2	81 0.33	39		
			0	0.04	0.96	1,500	0.66 23.3	9.5 0.04	14		
9GA0924P4S03			100	0.12	2.88	3,800	1.67 59.0	60.6 0.24	35		
			0	0.04	0.96	1,500	0.66 23.3	9.5 0.04	14		

※PWM Frequency : 25kHz

Some models can also be equipped without sensors or with pulse sensors (no PWM control functions) as an option. Please refer to the index (pp. 417 to 437).

Dimensions (unit : mm) (With ribs)

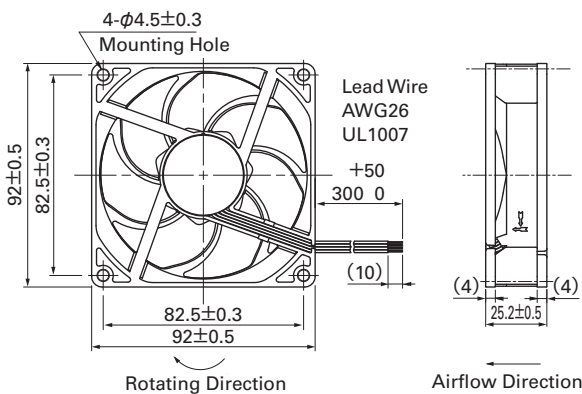

Reference Dimension of Mounting Holes and Vent Opening (unit : mm)

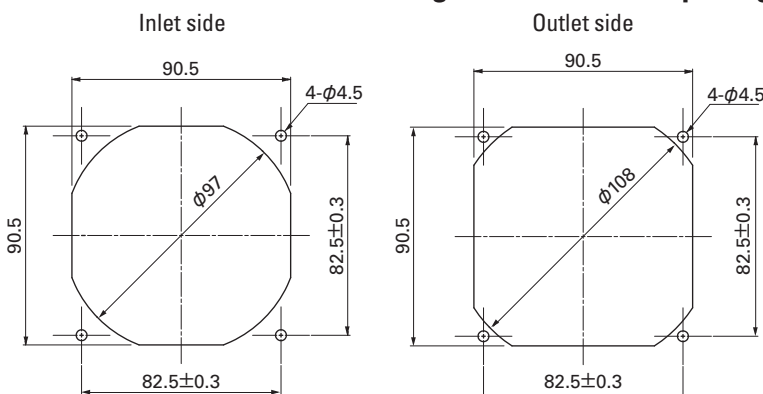

Options (unit : mm)

Finger Guards

Model : 109-099C Surface treatment : Nickel-chrome plating (silver) Color

Model : 109-099E Surface treatment : Nickel-chrome plating (silver) Color
: 109-099H : Cation electropainting (black)

Outlet side

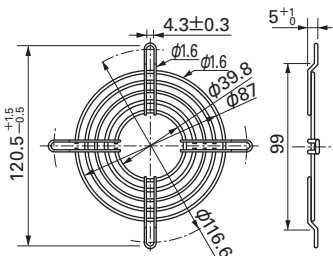

Mass : 22g

Inlet side, Outlet side

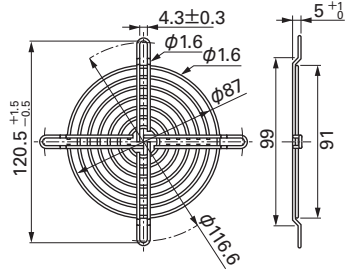

Mass : 29g

Resin Finger Guards

Model : 109-1001G

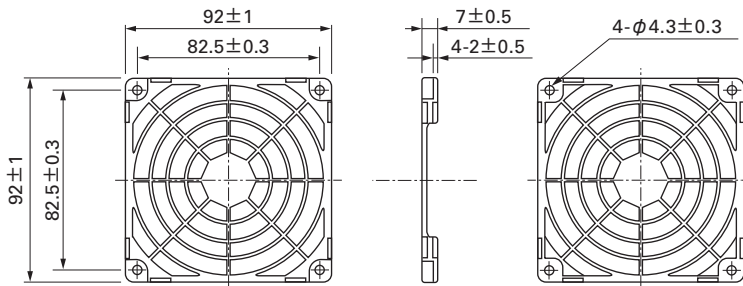

Mass : 12g

Resin Filter Kits

Model : 109-1001F13 (13PPI), 109-1001F20 (20PPI)
: 109-1001F30 (30PPI), 109-1001F40 (40PPI)

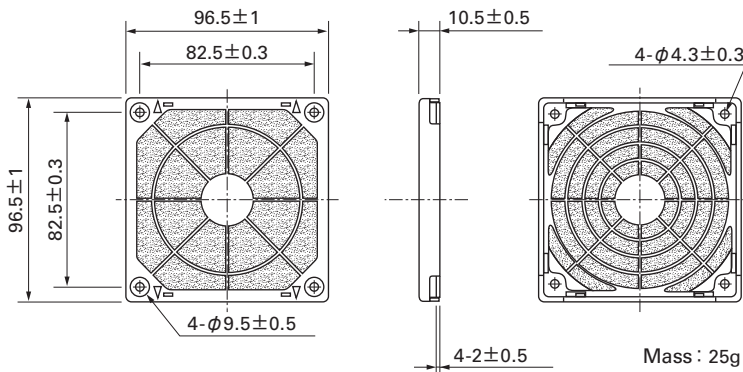

Mass : 25g

Airflow - Static Pressure Characteristics

PWM Duty Cycle

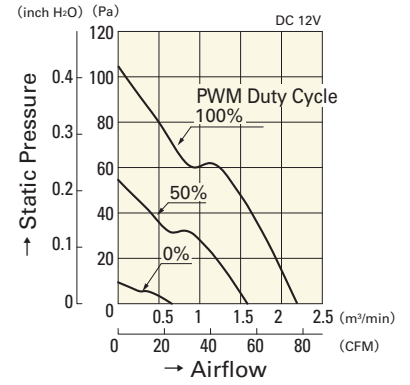

9GA0912P4J03

Operating Voltage Range

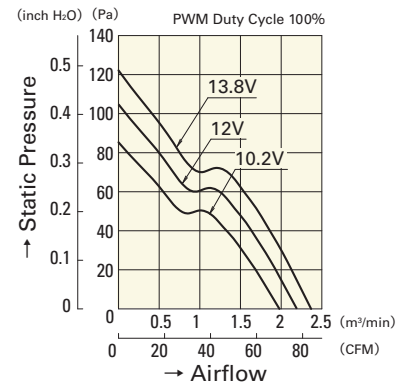

9GA0912P4J03

PWM Duty - Speed Characteristics Example

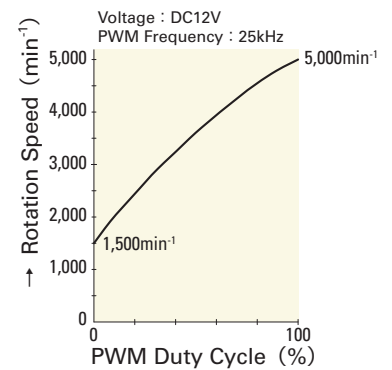

9GA0912P4J03

DC

DC Fan 92mm

92mm sq.

San Ace 92

92×92×25mm [Mass : 125g]

Airflow - Static Pressure Characteristics

PWM Duty Cycle

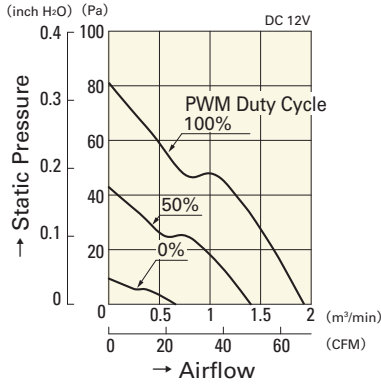

9GA0912P4G03

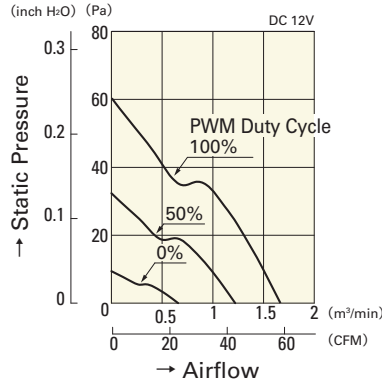

9GA0912P4S03

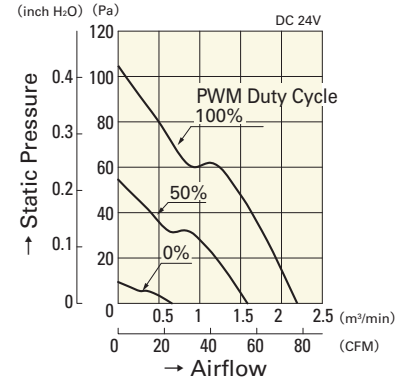

9GA0924P4J03

Operating Voltage Range

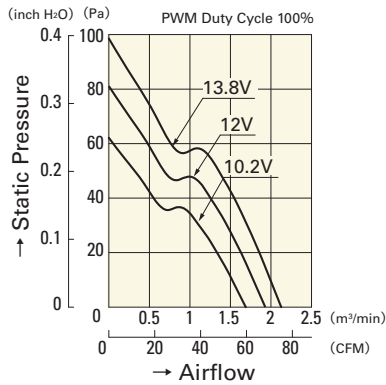

9GA0912P4G03

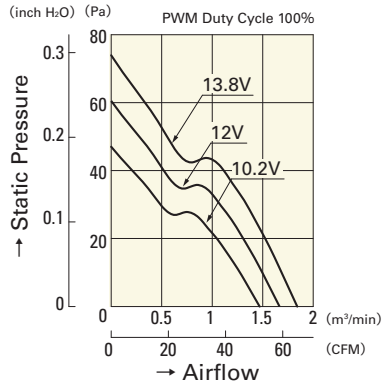

9GA0912P4S03

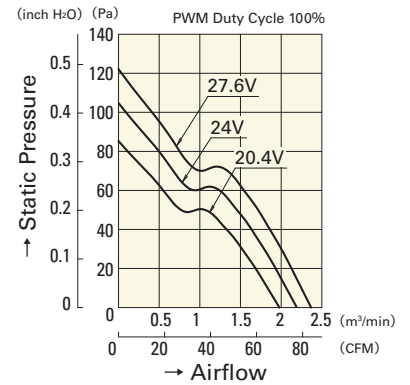

9GA0924P4J03

PWM Duty - Speed Characteristics Example

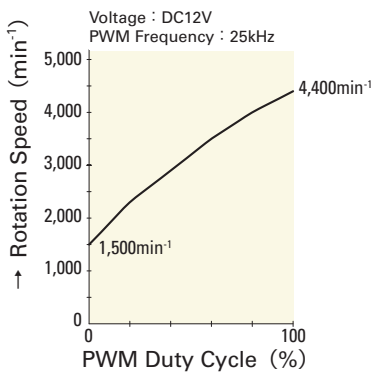

9GA0912P4G03

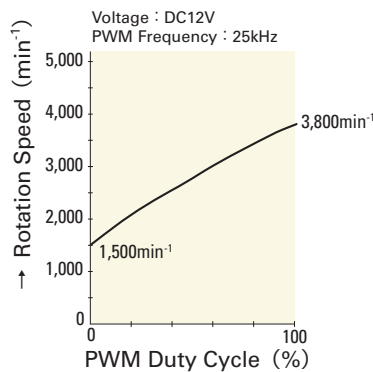

9GA0912P4S03

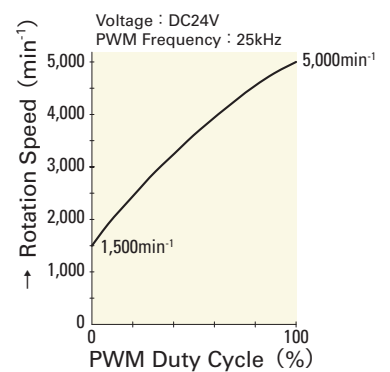

9GA0924P4J03

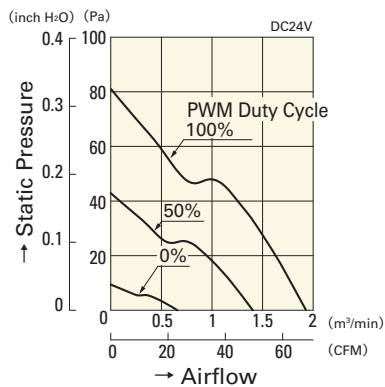

9GA0924P4G03

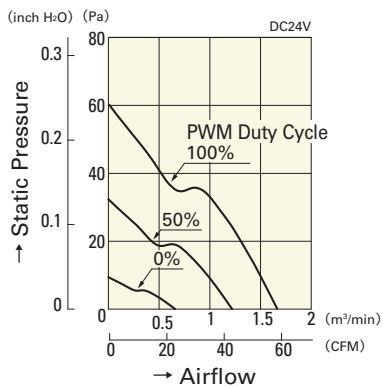

9GA0924P4S03

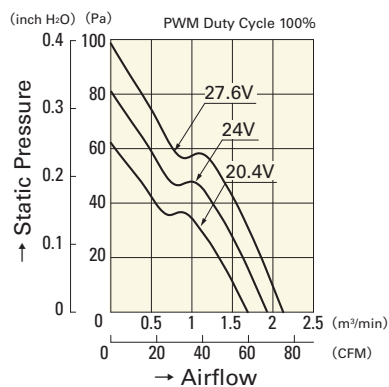

9GA0924P4G03

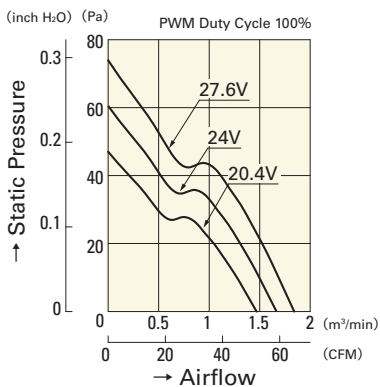

9GA0924P4S03

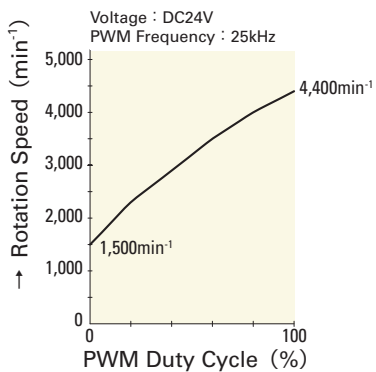

9GA0924P4G03

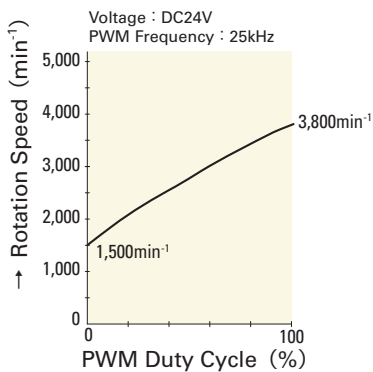

9GA0924P4S03