

Visualisation; Diagnostics

Easy to Configure

Programming IEC 61131-3

Rapid Installation

PSWZ X1P

PILZ

THE SPIRIT OF SAFETY

► Safe monitoring relays

This document is a translation of the original document.

All rights to this documentation are reserved by Pilz GmbH & Co. KG. Copies may be made for internal purposes. Suggestions and comments for improving this documentation will be gratefully received.

Source code from third-party manufacturers or open source software has been used for some components. The relevant licence information is available on the Internet on the Pilz homepage.

Pilz®, PIT®, PMI®, PNOZ®, Primo®, PSEN®, PSS®, PVIS®, SafetyBUS p®, SafetyEYE®, SafetyNET p®, the spirit of safety® are registered and protected trademarks of Pilz GmbH & Co. KG in some countries.



SD means Secure Digital

Introduction	5
Validity of documentation	5
Using the documentation	5
Definition of symbols	5
Safety	6
Intended use	6
Safety regulations	6
Safety assessment	6
Use of qualified personnel	7
Warranty and liability	7
Disposal	7
For your safety	7
Unit features	8
Safety features	8
Block diagram/terminal configuration	9
Function description	9
Operating modes	10
Timing diagram	11
Installation	11
Wiring	11
Preparing for operation	13
Connection	13
Set standstill detection	14
Application example	15
Operation	16
Status indicators	16
Fault indicators	16
Faults – Interference	17
Dimensions in mm	17
Technical details	18
Safety characteristic data	30
Supplementary data	31
Service life graph	31

Order reference	32
EC declaration of conformity	33

Introduction

Validity of documentation

This documentation is valid for the product PSWZ X1P. It is valid until new documentation is published.

This operating manual explains the function and operation, describes the installation and provides guidelines on how to connect the product.

Using the documentation

This document is intended for instruction. Only install and commission the product if you have read and understood this document. The document should be retained for future reference.

Definition of symbols

Information that is particularly important is identified as follows:



DANGER!

This warning must be heeded! It warns of a hazardous situation that poses an immediate threat of serious injury and death and indicates preventive measures that can be taken.



WARNING!

This warning must be heeded! It warns of a hazardous situation that could lead to serious injury and death and indicates preventive measures that can be taken.



CAUTION!

This refers to a hazard that can lead to a less serious or minor injury plus material damage, and also provides information on preventive measures that can be taken.



NOTICE

This describes a situation in which the product or devices could be damaged and also provides information on preventive measures that can be taken. It also highlights areas within the text that are of particular importance.

**INFORMATION**

This gives advice on applications and provides information on special features.

Safety**Intended use**

The PSWZ X1P is used for safe standstill monitoring.

The unit is designed for use with

- ▶ Standstill monitoring at plants with dangerous machine parts or tools in safety circuits in accordance with VDE 0113-1 and EN 60204-1

Standstill is only detected on power-free measuring circuits. Residual voltages, induced voltages or drives within the position control will prevent safe standstill detection!

The following is deemed improper use in particular:

- ▶ Any component, technical or electrical modification to the product
- ▶ Use of the product outside the areas described in this manual
- ▶ Use of the product outside the technical details (see [Technical details](#) [ 18]).

**NOTICE****EMC-compliant electrical installation**

The product is designed for use in an industrial environment. The product may cause interference if installed in other environments. If installed in other environments, measures should be taken to comply with the applicable standards and directives for the respective installation site with regard to interference.

Safety regulations**Safety assessment**

Before using a unit it is necessary to perform a safety assessment in accordance with the Machinery Directive.

Functional safety is guaranteed for the product as a single component. However, this does not guarantee the functional safety of the overall plant/machine. In order to achieve the required safety level for the overall plant/machine, define the safety requirements for the plant/machine and then define how these must be implemented from a technical and organisational standpoint.

Use of qualified personnel

The products may only be assembled, installed, programmed, commissioned, operated, maintained and decommissioned by competent persons.

A competent person is someone who, because of their training, experience and current professional activity, has the specialist knowledge required to test, assess and operate the work equipment, devices, systems, plant and machinery in accordance with the general standards and guidelines for safety technology.

It is the company's responsibility only to employ personnel who:

- ▶ Are familiar with the basic regulations concerning health and safety / accident prevention
- ▶ Have read and understood the information provided in this description under "Safety"
- ▶ And have a good knowledge of the generic and specialist standards applicable to the specific application.

Warranty and liability

All claims to warranty and liability will be rendered invalid if

- ▶ The product was used contrary to the purpose for which it is intended
- ▶ Damage can be attributed to not having followed the guidelines in the manual
- ▶ Operating personnel are not suitably qualified
- ▶ Any type of modification has been made (e.g. exchanging components on the PCB boards, soldering work etc.).

Disposal

- ▶ In safety-related applications, please comply with the mission time T_M in the safety-related characteristic data.
- ▶ When decommissioning, please comply with local regulations regarding the disposal of electronic devices (e.g. Electrical and Electronic Equipment Act).

For your safety

The unit meets all the necessary conditions for safe operation. However, please note the following:

- ▶ Note for overvoltage category III: If voltages higher than low voltage (>50 VAC or >120 VDC) are present on the unit, connected control elements and sensors must have a rated insulation voltage of at least 250 V.

Unit features

- ▶ Measuring inputs for 3- or 1-phase motors
- ▶ Measuring voltage on both channels can be set jointly
- ▶ 1 Reset input
- ▶ Positive-guided relay outputs:
 - 2 safety contacts (N/O), instantaneous
 - 1 auxiliary contact (N/C), instantaneous
- ▶ 2 semiconductor outputs
- ▶ LED display for:
 - Standstill on channel 1/2
 - Supply voltage/fault
- ▶ Semiconductor outputs signal:
 - Supply voltage/fault
 - Switch status
- ▶ Feedback loop for monitoring external contactors
- ▶ Plug-in connection terminals (either spring-loaded terminal or screw terminal)
- ▶ See order reference for unit types

Safety features

- ▶ The relay meets the following safety requirements:
 - The circuit is redundant with built-in self-monitoring.
 - The safety device remains effective in the case of a component failure.
 - The correct opening and closing of the safety device relays is tested automatically in each on-off cycle.
- ▶ The unit monitors the measuring circuits for open circuit. If an open circuit occurs between the unit and the motor or on the motor itself, the unit immediately switches off.
- ▶ The standstill monitor prevents the plant from being enabled in the following cases:
 - Power supply failure
 - Component failure
 - Measuring circuits are open circuit
 - Coil defect/open circuit

Block diagram/terminal configuration

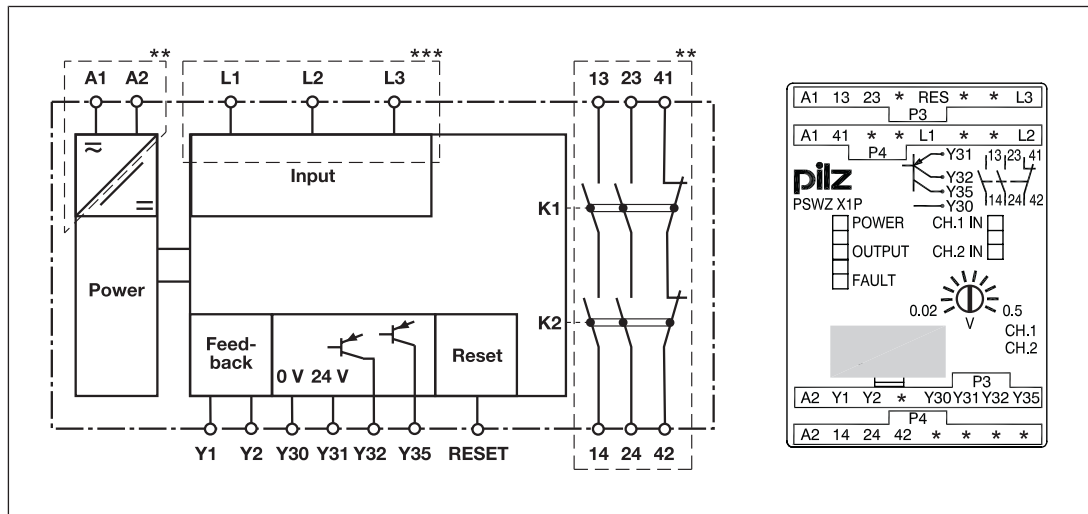

**Insulation against the non-marked area and between the relay contacts: Basic insulation (overvoltage category III), protective separation (overvoltage category II); at 250 V, 4 kV

***Insulation against the non-marked area and between the measurement connections: Basic insulation (overvoltage category III), protective separation (overvoltage category II); at 690 V, 6 kV

- ▶ Channel 1: L1-L3
- ▶ Channel 2: L2-L3

Function description

The device uses two separate measuring channels to measure the regenerated voltage, induced from the motor during the rundown period. If the voltage falls below the set response value (standstill threshold), the PSWZ X1P enables the monitored plant.

When used with frequency converters, the PSWZ X1P cannot detect standstill until the controller inhibit has been switched off.

After the supply voltage U_B is switched on, the unit performs a self test. The unit simulates a situation in which the release value is exceeded and the measuring circuit has an open circuit. The correct function of the output relay and feedback loop is also tested. The test takes approx. 1.5 s.

The unit is ready for operation when the feedback loop is closed and the measuring circuits are not interrupted.

- ▶ Procedure when the measuring voltage falls below the response value U_{on} on both channels L1-L3 and L2-L3:
 - LEDs "POWER", "CH.1 IN", "CH.2 IN" and "OUTPUT" are lit.
 - Safety contacts 13-14 and 23-24 are closed, auxiliary contact 41-42 is open.
 - A high signal is present at semiconductor output Y32.

- ▶ Procedure when after the motor has started, the voltage in one of the two measuring circuits exceeds the release value U_{off} :
 - Safety contacts 13-14 and 23-24 are opened redundantly, auxiliary contact 41-42 is closed.
 - A low signal is present at semiconductor output Y32.
 - LEDs "CH.1 IN", "CH.2 IN" and "OUTPUT" go out.

To reactivate, the voltage at both channels L1-L3 and L2-L3 must fall below the response value U_{on} within the time t_g (simultaneity monitoring) and the feedback loop must be closed. The response value U_{on} can be set jointly for both channels in order to suit the motor that is to be monitored. The release value U_{off} (hysteresis) corresponds to twice the response value.

If the simultaneity requirement is exceeded, the "FAULT" LED is lit and on the semiconductor output Y35 there is a High signal. The PSWZ X1P does not enable the monitored plant. The fault is reset by applying a High signal and then a Low signal at the reset input.

Self test

An internal self test is carried out during initial commissioning and each time the supply voltage is switched off and on. The process simulates switching all measuring voltages on and then off again. Provided no error occurs during the self test, the unit will then be ready for operation.

Operating modes

- ▶ Single-phase operation:
 - One measuring circuit (calculated at two different measuring points) affects both channels
- ▶ Three-phase operation:
 - Two redundant (identical) measuring circuits affect channel 1 and 2
 - Voltages in the measuring circuit are monitored (failsafe in the event of a short circuit)

Timing diagram

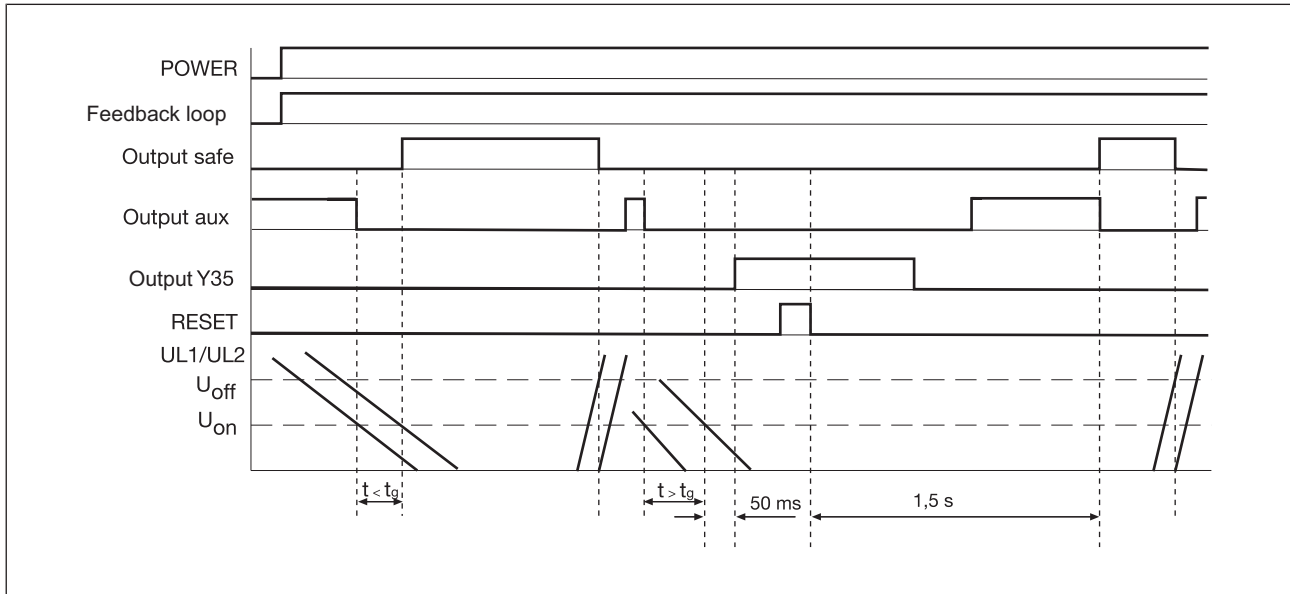

Legend

- ▶ POWER: Supply voltage
- ▶ UL1/UL2: Input circuit L1, L2, L3
- ▶ Feedback loop: Feedback loop Y1-Y2
- ▶ Output safe: Safety contacts 13-14, 23-24
- ▶ Output aux: Auxiliary contact 41-42
- ▶ Output Y35: Semiconductor output for fault signal
- ▶ RESET: Reset input
- ▶ U_{on} : Response value
- ▶ U_{off} : Release value
- ▶ t_g : Simultaneity

Installation

- ▶ The unit should be installed in a control cabinet with a protection type of at least IP54.
- ▶ Use the notch on the rear of the unit to attach it to a DIN rail.
- ▶ Ensure the unit is mounted securely on a vertical DIN rail (35 mm) by using a fixing element (e.g. retaining bracket or an end angle).

Wiring

Please note:

- ▶ Information given in the "[Technical details \[18\]](#)" must be followed.
- ▶ Outputs 13-14, 23-24 are safety contacts, the output 41-42 is an auxiliary contact (e.g. for display).
- ▶ Auxiliary contact 41-42 should **not** be used for safety circuits!
- ▶ To prevent contact welding, a fuse should be connected before the output contacts (see [Technical details \[18\]](#)).

- ▶ Calculation of the max. cable length l_{\max} in the input circuit:

$$l_{\max} = \frac{R_{l_{\max}}}{R_l / \text{km}}$$



$R_{l_{\max}}$ = max. overall cable resistance (see [Technical details](#) [ 18])

R_l / km = cable resistance/km

- ▶ Use copper wire that can withstand 60/75 °C.
- ▶ Sufficient fuse protection must be provided on all output contacts with capacitive and inductive loads.
- ▶ Do not switch low currents using contacts that have been used previously with high currents.
- ▶ Ensure the wiring and EMC requirements of IEC 60204-1 are met.
- ▶ When used with converters: Please comply with the information regarding installation and wiring in the documentation of the converter. Use screened cable for the wiring between the PSWZ X1P and the motor. Connect the cable screening on the motor.
- ▶ Protect the measuring circuits according to the conductor cross section.
- ▶ Single-phase motor: Connect terminal L1 directly to motor connection terminal L, and terminal L3 directly to motor connection terminal N. Connect terminal L2 directly to the element that switches the motor on (contactor, converter, etc.). Separate cables with separate insulation should be used for the measuring voltages L1 and L2. The cables should also be physically separate.
- ▶ Three-phase motor: Connect the connection terminals L1, L2 and L3 directly to the motor connection terminals L1, L2 and L3.
- ▶ Do **not** connect the terminals labelled "***".

Preparing for operation

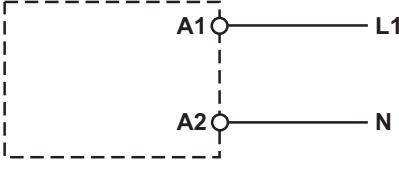
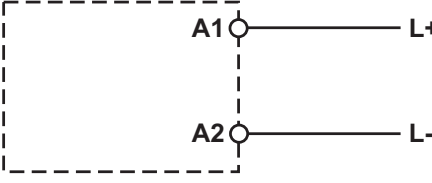
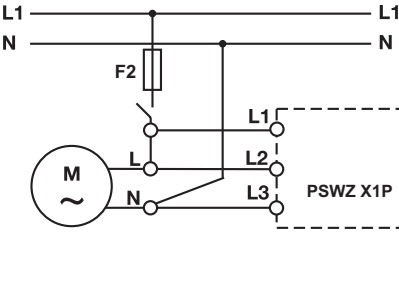
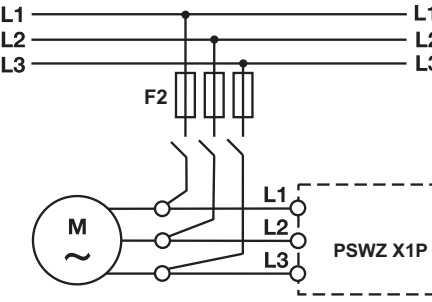
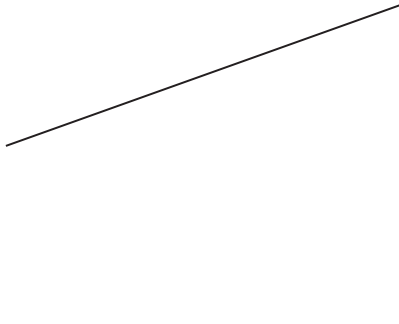
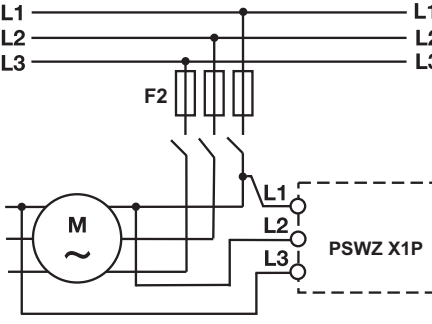
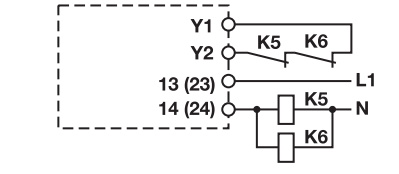
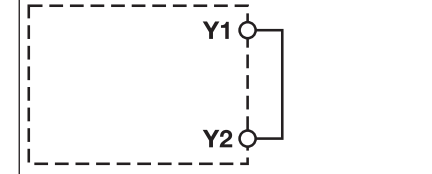
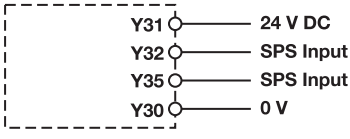
Connection

Supply voltage	AC	DC
		
Input circuit	Single-phase motor	Three-phase motor
<p>Single-phase motor = single-phase measurement signal evaluation</p> <p>Three-phase motor = two-phase measurement signal evaluation</p>		
<p>Single-phase measurement signal evaluation</p>		
Feedback loop	with feedback loop monitoring	without feedback loop monitoring
<p>Contacts from external contactors or link</p>		
Semiconductor output		
<p>Y32: Semiconductor output for switch status</p> <p>Y35: Semiconductor output for fault signal</p>		
Semiconductor input		
		

Set standstill detection

- ▶ Turn the potentiometer to the left-hand stop (default setting)
- ▶ Set standstill detection
 - At motor standstill, the LEDs "CH.1 IN" and "CH.2 IN" must light up. If the LEDs do not light in the default setting, turn the potentiometer gradually to the right until the LEDs "CH.1 IN" and "CH.2 IN" light up.
 - If the simultaneity requirement is met, the "OUTPUT" LED will also light up. Safety contacts 13-14 and 23-24 are closed, auxiliary contact 41-42 is open, there is a High signal at the semiconductor output Y32.
 - If the simultaneity requirement is exceeded, the "FAULT" LED will light up. Safety contacts 13-14 and 23-24 are open, auxiliary contact 41-42 is closed, a low signal is present at semiconductor output Y32. Reset the error by a pulse (High- Low- signal) at the reset input.
- ▶ Test standstill detection
 - Close the feedback loop, start up the motor and then switch it off again. As soon as the motor is at standstill, the LEDs "CH.1 IN", "CH.2 IN" and "OUTPUT" light up. Safety contacts 13-14 and 23-24 are closed, auxiliary contact 41-42 is open, there is a High signal at the semiconductor output Y32.

Application example

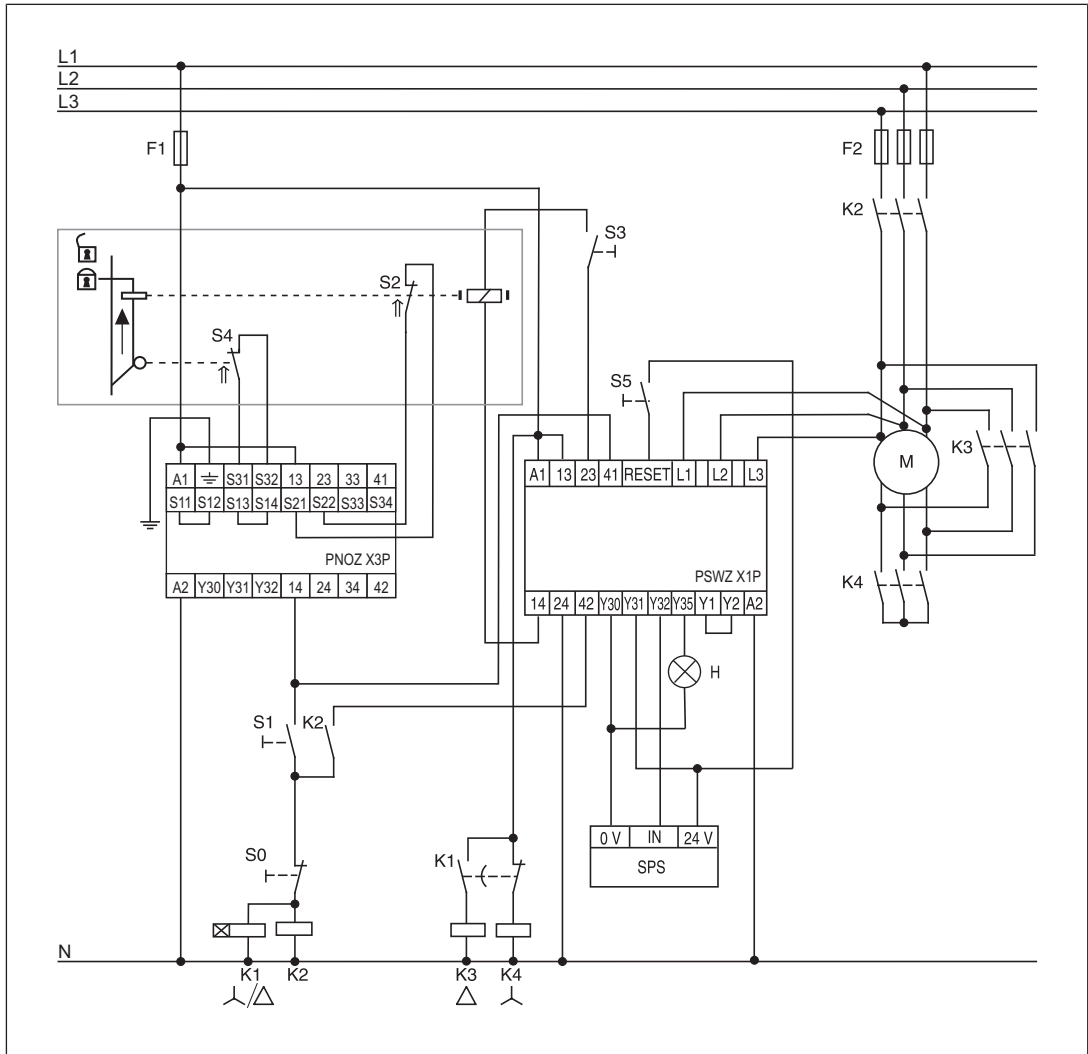

Standstill detection only with closed star contactor contacts

Legend

- ▶ S0: Off switch
- ▶ S1: On switch
- ▶ S2/S4: Safety gate switch
- ▶ S3: Release
- ▶ S5: Reset button
- ▶ K1: Star/delta control relay
- ▶ K2: Motor contactor
- ▶ K3: Delta contactor
- ▶ K4: Star contactor
- ▶ H: Fault indicator
- ▶ ↑↑: Operated element
- ▶ : Gate open

- ▶ : Gate closed

Operation



NOTICE

The safety function should be checked after initial commissioning and each time the plant/machine is changed. The safety functions may only be checked by qualified personnel.



NOTICE

When operated with increased safety (e.g. safe standstill monitoring), the following test must be performed at least once a week:

- Start up the motor. All LEDs except "POWER" must go out. Safety contacts 13-14 and 23-24 must be open and auxiliary contact 41-42 must be closed.
- Switch the motor off again. The LEDs "CH.1 IN", "CH.2 IN" and "OUTPUT" should not light up / safety contacts 13-14 and 23-24 should not be closed and the auxiliary contact 41-42 open until the motor shaft has come to a standstill.

LEDs indicate the status and errors during operation:



LED on

Status indicators



POWER

Supply voltage is present.



CH.1 IN

Channel 1 safety contacts are closed.



CH.2 IN

Channel 2 safety contacts are closed.



OUTPUT

Safety contacts are closed and semiconductor output Y32 carries a high signal.

Fault indicators



FAULT

Diagnostics: Simultaneity requirement is exceeded or single-channel exceeding and subsequent value falls again below the standstill threshold U_{off}

- ▶ Remedy: Reset the error by supplying a High signal and then a Low signal at the Reset input.

Faults – Interference

- ▶ LED "POWER" does not light: Short circuit or no supply voltage.
- ▶ Contact malfunctions: If the contacts have welded, reactivation will not be possible after the input circuit has opened.
- ▶ When exceeding the simultaneity time the safety contacts 13-14, 23-24 remain open.

Dimensions in mm

* with spring-loaded terminals

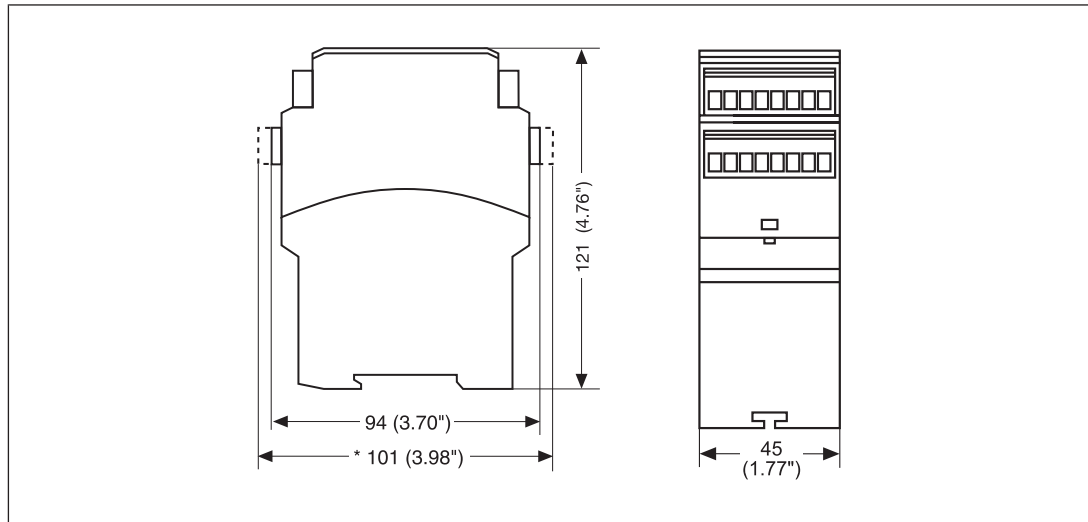

Technical details

Order no. 777949 – 777950

See below for more order numbers

General	777949	777950
Approvals	CCC, CE, EAC (Eurasian), TÜV, cULus Listed	CCC, CE, EAC (Eurasian), TÜV, cULus Listed
Electrical data	777949	777950
Supply voltage		
Voltage	24 - 240 V	24 - 240 V
Kind	AC/DC	AC/DC
Voltage tolerance	-15 %/+10 %	-15 %/+10 %
Output of external power supply (AC)	5 VA	5 VA
Output of external power supply (DC)	3 W	3 W
Frequency range AC	50 - 60 Hz	50 - 60 Hz
Residual ripple DC	160 %	160 %
Max. inrush current at UB	10 A	10 A
Duty cycle	100 %	100 %
Measuring circuit	777949	777950
Min. measuring voltage	0,0 V	0,0 V
Max. measuring voltage	690 V	690 V
Measuring voltage in accordance with UL	600 V	600 V
Frequency range	0 - 3 kHz	0 - 3 kHz
Input resistance	1.300 kOhm	1.300 kOhm
Switching threshold per channel		
Response value U _{on} (adjustable)	20 - 500 mV	120 - 3000 mV
Release value U _{off}	2 x U _{on}	2 x U _{on}
Inputs	777949	777950
Voltage at		
Feedback loop DC	24 V	24 V
Current at		
Feedback loop DC	35 mA	35 mA
Max. inrush current impulse		
Current pulse, feedback loop	0,12 A	0,12 A
Pulse duration, feedback loop	0,1 s	0,1 s
Reset input	777949	777950
Low signal	< 5 V	< 5 V
High signal	> 15 V	> 15 V
Current	20 mA	20 mA
Semiconductor outputs	777949	777950
Number	2	2

Semiconductor outputs	777949	777950
Voltage	24 V	24 V
Current	50 mA	50 mA
External supply voltage	24 V	24 V
Voltage tolerance	-20 %/+20 %	-20 %/+20 %
Relay outputs	777949	777950
Number of output contacts		
Safety contacts (N/O), instantaneous	2	2
Auxiliary contacts (N/C)	1	1
Max. short circuit current I _K	1 kA	1 kA
Utilisation category		
In accordance with the standard	EN 60947-4-1	EN 60947-4-1
Utilisation category of safety contacts		
AC1 at	240 V	240 V
Min. current	0,01 A	0,01 A
Max. current	6 A	6 A
Max. power	1500 VA	1500 VA
DC1 at	24 V	24 V
Min. current	0,01 A	0,01 A
Max. current	6 A	6 A
Max. power	150 W	150 W
Utilisation category of auxiliary contacts		
AC1 at	240 V	240 V
Min. current	0,01 A	0,01 A
Max. current	6 A	6 A
Max. power	1500 VA	1500 VA
DC1 at	24 V	24 V
Min. current	0,01 A	0,01 A
Max. current	6 A	6 A
Max. power	150 W	150 W
Utilisation category		
In accordance with the standard	EN 60947-5-1	EN 60947-5-1
Utilisation category of safety contacts		
AC15 at	230 V	230 V
Max. current	3 A	3 A
DC13 (6 cycles/min) at	24 V	24 V
Max. current	4 A	4 A
Utilisation category of auxiliary contacts		
AC15 at	230 V	230 V
Max. current	3 A	3 A
DC13 (6 cycles/min) at	24 V	24 V
Max. current	4 A	4 A

Relay outputs	777949	777950
Utilisation category in accordance with UL		
Voltage	240 V AC G. P.	240 V AC G. P.
With current	6 A	6 A
External contact fuse protection, safety contacts		
In accordance with the standard	EN 60947-5-1	EN 60947-5-1
Max. melting integral	66 A²s	66 A²s
Blow-out fuse, quick	6 A	6 A
Blow-out fuse, slow	4 A	4 A
Blow-out fuse, gG	6 A	6 A
Circuit breaker 24V AC/DC, characteristic B/C	4 A	4 A
External contact fuse protection, auxiliary contacts		
Max. melting integral	66 A²s	66 A²s
Blow-out fuse, quick	6 A	6 A
Blow-out fuse, slow	4 A	4 A
Blow-out fuse, gG	6 A	6 A
Circuit breaker 24 V AC/DC, characteristic B/C	4 A	4 A
Conventional thermal current	6 A	6 A
Contact material	AgCuNi + 0,2 µm Au	AgCuNi + 0,2 µm Au
Conventional thermal current while loading several contacts	777949	777950
I _{th} per contact at UB DC; AC1: 240 V, DC1: 24 V		
Conv. therm. current with 1 contact	6 A	6 A
Conv. therm. current with 2 contacts	4 A	4 A
Times	777949	777950
Delay-on de-energisation		
After motor on max.	170 ms	170 ms
Max. switch-on delay		
After motor standstill max.	1.500 ms	1.500 ms
After power on max.	2.200 ms	2.200 ms
Recovery time at max. switching frequency 1/s		
After motor on	2.200 ms	2.200 ms
Supply interruption before de-energisation	20 ms	20 ms
Simultaneity, channel 1 and 2 max.	7 s	7 s
Environmental data	777949	777950
Climatic suitability	EN 60068-2-78	EN 60068-2-78
Ambient temperature		
Temperature range	-10 - 55 °C	-10 - 55 °C

Environmental data	777949	777950
Storage temperature		
Temperature range	-40 - 85 °C	-40 - 85 °C
Climatic suitability		
Humidity	93 % r. h. at 40 °C	93 % r. h. at 40 °C
Condensation during operation	Not permitted	Not permitted
EMC	EN 60947-5-1, EN 61000-6-2, EN 61000-6-4, EN 61326-3-1	EN 60947-5-1, EN 61000-6-2, EN 61000-6-4, EN 61326-3-1
Vibration		
In accordance with the standard	EN 60068-2-6	EN 60068-2-6
Frequency	10 - 55 Hz	10 - 55 Hz
Amplitude	0,35 mm	0,35 mm
Airgap creepage		
In accordance with the standard	EN 60947-1	EN 60947-1
Overvoltage category	III / II	III / II
Pollution degree	2	2
Rated insulation voltage	690 V	690 V
Rated impulse withstand voltage	6 kV	6 kV
Protection type		
Mounting area (e.g. control cabinet)	IP54	IP54
Housing	IP40	IP40
Terminals	IP20	IP20
Mechanical data	777949	777950
Mounting position	Any	Any
Mechanical life	10,000,000 cycles	10,000,000 cycles
Material		
Bottom	PPO UL 94 V0	PPO UL 94 V0
Front	ABS UL 94 V0	ABS UL 94 V0
Top	PPO UL 94 V0	PPO UL 94 V0
Connection type	Screw terminal	Screw terminal
Mounting type	plug-in	plug-in
Conductor cross section with screw terminals		
1 core flexible	0,25 - 2,5 mm², 24 - 14 AWG	0,25 - 2,5 mm², 24 - 14 AWG
2 core with the same cross section, flexible with crimp connectors, no plastic sleeve	0,25 - 1 mm², 24 - 16 AWG	0,25 - 1 mm², 24 - 16 AWG
2 core with the same cross section, flexible without crimp connectors or with TWIN crimp connectors	0,5 - 1,5 mm², 24 - 16 AWG	0,5 - 1,5 mm², 24 - 16 AWG
Torque setting with screw terminals	0,6 Nm	0,6 Nm
Dimensions		
Height	94 mm	94 mm
Width	45 mm	45 mm
Depth	121 mm	121 mm
Weight	325 g	325 g

Where standards are undated, the 2014-07 latest editions shall apply.

Order no. 777951 – 777959

See below for more order numbers

General	777951	777959
Approvals	CCC, CE, EAC (Eurasian), TÜV, cULus Listed	CCC, CE, EAC (Eurasian), TÜV, cULus Listed
Electrical data	777951	777959
Supply voltage		
Voltage	24 - 240 V	24 - 240 V
Kind	AC/DC	AC/DC
Voltage tolerance	-15 %/+10 %	-15 %/+10 %
Output of external power supply (AC)	5 VA	5 VA
Output of external power supply (DC)	3 W	3 W
Frequency range AC	50 - 60 Hz	50 - 60 Hz
Residual ripple DC	160 %	160 %
Max. inrush current at UB	10 A	10 A
Duty cycle	100 %	100 %
Measuring circuit	777951	777959
Min. measuring voltage	0,0 V	0,0 V
Max. measuring voltage	690 V	690 V
Measuring voltage in accordance with UL	600 V	600 V
Frequency range	0 - 3 kHz	0 - 3 kHz
Input resistance	1.300 kOhm	1.300 kOhm
Switching threshold per channel		
Response value Uon (adjustable)	7,5 - 500 mV	20 - 500 mV
Release value Uoff	2 x Uon	2 x Uon
Inputs	777951	777959
Voltage at		
Feedback loop DC	24 V	24 V
Current at		
Feedback loop DC	35 mA	35 mA
Max. inrush current impulse		
Current pulse, feedback loop	0,12 A	0,12 A
Pulse duration, feedback loop	0,1 s	0,1 s
Reset input	777951	777959
Low signal	< 5 V	< 5 V
High signal	> 15 V	> 15 V
Current	20 mA	20 mA

Semiconductor outputs	777951	777959
Number	2	2
Voltage	24 V	24 V
Current	50 mA	50 mA
External supply voltage	24 V	24 V
Voltage tolerance	-20 %/+20 %	-20 %/+20 %
Relay outputs	777951	777959
Number of output contacts		
Safety contacts (N/O), instantaneous	2	2
Auxiliary contacts (N/C)	1	1
Max. short circuit current IK	1 kA	1 kA
Utilisation category		
In accordance with the standard	EN 60947-4-1	EN 60947-4-1
Utilisation category of safety contacts		
AC1 at	240 V	240 V
Min. current	0,01 A	0,01 A
Max. current	6 A	6 A
Max. power	1500 VA	1500 VA
DC1 at	24 V	24 V
Min. current	0,01 A	0,01 A
Max. current	6 A	6 A
Max. power	150 W	150 W
Utilisation category of auxiliary contacts		
AC1 at	240 V	240 V
Min. current	0,01 A	0,01 A
Max. current	6 A	6 A
Max. power	1500 VA	1500 VA
DC1 at	24 V	24 V
Min. current	0,01 A	0,01 A
Max. current	6 A	6 A
Max. power	150 W	150 W
Utilisation category		
In accordance with the standard	EN 60947-5-1	EN 60947-5-1
Utilisation category of safety contacts		
AC15 at	230 V	230 V
Max. current	3 A	3 A
DC13 (6 cycles/min) at	24 V	24 V
Max. current	4 A	4 A

Relay outputs	777951	777959
Utilisation category of auxiliary contacts		
AC15 at	230 V	230 V
Max. current	3 A	3 A
DC13 (6 cycles/min) at	24 V	24 V
Max. current	4 A	4 A
Utilisation category in accordance with UL		
Voltage	240 V AC G. P.	240 V AC G. P.
With current	6 A	6 A
External contact fuse protection, safety contacts		
In accordance with the standard	EN 60947-5-1	EN 60947-5-1
Max. melting integral	66 A²s	66 A²s
Blow-out fuse, quick	6 A	6 A
Blow-out fuse, slow	4 A	4 A
Blow-out fuse, gG	6 A	6 A
Circuit breaker 24V AC/DC, characteristic B/C	4 A	4 A
External contact fuse protection, auxiliary contacts		
Max. melting integral	66 A²s	66 A²s
Blow-out fuse, quick	6 A	6 A
Blow-out fuse, slow	4 A	4 A
Blow-out fuse, gG	6 A	6 A
Circuit breaker 24 V AC/DC, characteristic B/C	4 A	4 A
Conventional thermal current	6 A	6 A
Contact material	AgCuNi + 0,2 µm Au	AgCuNi + 0,2 µm Au
Conventional thermal current while loading several contacts	777951	777959
I _{th} per contact at UB DC; AC1: 240 V, DC1: 24 V		
Conv. therm. current with 1 contact	6 A	6 A
Conv. therm. current with 2 contacts	4 A	4 A
Times	777951	777959
Delay-on de-energisation		
After motor on max.	170 ms	170 ms
Max. switch-on delay		
After motor standstill max.	1.500 ms	1.500 ms
After power on max.	2.200 ms	2.200 ms
Recovery time at max. switching frequency 1/s		
After motor on	2.200 ms	2.200 ms
Supply interruption before de-energisation		
	20 ms	20 ms

Times	777951	777959
Simultaneity, channel 1 and 2 max.	7 s	7 s
Environmental data	777951	777959
Climatic suitability	EN 60068-2-78	EN 60068-2-78
Ambient temperature		
Temperature range	-10 - 55 °C	-10 - 55 °C
Storage temperature		
Temperature range	-40 - 85 °C	-40 - 85 °C
Climatic suitability		
Humidity	93 % r. h. at 40 °C	93 % r. h. at 40 °C
Condensation during operation	Not permitted	Short-term
EMC	EN 60947-5-1, EN 61000-6-2, EN 61000-6-4, EN 61326-3-1	EN 60947-5-1, EN 61000-6-2, EN 61000-6-4, EN 61326-3-1
Vibration		
In accordance with the standard	EN 60068-2-6	EN 60068-2-6
Frequency	10 - 55 Hz	10 - 55 Hz
Amplitude	0,35 mm	0,35 mm
Airgap creepage		
In accordance with the standard	EN 60947-1	EN 60947-1
Overvoltage category	III / II	III / II
Pollution degree	2	2
Rated insulation voltage	690 V	690 V
Rated impulse withstand voltage	6 kV	6 kV
Protection type		
Mounting area (e.g. control cabinet)	IP54	IP54
Housing	IP40	IP40
Terminals	IP20	IP20
Mechanical data	777951	777959
Mounting position	Any	Any
Mechanical life	10,000,000 cycles	10,000,000 cycles
Material		
Bottom	PPO UL 94 V0	PPO UL 94 V0
Front	ABS UL 94 V0	ABS UL 94 V0
Top	PPO UL 94 V0	PPO UL 94 V0
Connection type	Screw terminal	Screw terminal
Mounting type	plug-in	plug-in
Conductor cross section with screw terminals		
1 core flexible	0,25 - 2,5 mm², 24 - 14 AWG	0,25 - 2,5 mm², 24 - 14 AWG
2 core with the same cross section, flexible with crimp connectors, no plastic sleeve	0,25 - 1 mm², 24 - 16 AWG	0,25 - 1 mm², 24 - 16 AWG
2 core with the same cross section, flexible without crimp connectors or with TWIN crimp connectors	0,5 - 1,5 mm², 24 - 16 AWG	0,5 - 1,5 mm², 24 - 16 AWG
Torque setting with screw terminals	0,6 Nm	0,6 Nm

Mechanical data	777951	777959
Dimensions		
Height	94 mm	94 mm
Width	45 mm	45 mm
Depth	121 mm	121 mm
Weight	325 g	325 g

Where standards are undated, the 2014-07 latest editions shall apply.

Order no. 787949 – 787951

General	787949	787950	787951
Approvals	CCC, CE, EAC (Eurasian), TÜV, cULus Listed	CCC, CE, EAC (Eurasian), TÜV, cULus Listed	CCC, CE, EAC (Eurasian), TÜV, cULus Listed
Electrical data	787949	787950	787951
Supply voltage			
Voltage	24 - 240 V	24 - 240 V	24 - 240 V
Kind	AC/DC	AC/DC	AC/DC
Voltage tolerance	-15 %/+10 %	-15 %/+10 %	-15 %/+10 %
Output of external power supply (AC)	5 VA	5 VA	5 VA
Output of external power supply (DC)	3 W	3 W	3 W
Frequency range AC	50 - 60 Hz	50 - 60 Hz	50 - 60 Hz
Residual ripple DC	160 %	160 %	160 %
Max. inrush current at UB	10 A	10 A	10 A
Duty cycle	100 %	100 %	100 %
Measuring circuit	787949	787950	787951
Min. measuring voltage	0,0 V	0,0 V	0,0 V
Max. measuring voltage	690 V	690 V	690 V
Measuring voltage in accordance with UL	600 V	600 V	600 V
Frequency range	0 - 3 kHz	0 - 3 kHz	0 - 3 kHz
Input resistance	1.300 kOhm	1.300 kOhm	1.300 kOhm
Switching threshold per channel			
Response value U _{on} (adjustable)	20 - 500 mV	120 - 3000 mV	7,5 - 500 mV
Release value U _{off}	2 x U_{on}	2 x U_{on}	2 x U_{on}
Inputs	787949	787950	787951
Voltage at			
Feedback loop DC	24 V	24 V	24 V
Current at			
Feedback loop DC	35 mA	35 mA	35 mA

Inputs	787949	787950	787951
Max. inrush current impulse			
Current pulse, feedback loop	0,12 A	0,12 A	0,12 A
Pulse duration, feedback loop	0,1 s	0,1 s	0,1 s
Reset input	787949	787950	787951
Low signal	< 5 V	< 5 V	< 5 V
High signal	> 15 V	> 15 V	> 15 V
Current	20 mA	20 mA	20 mA
Semiconductor outputs	787949	787950	787951
Number	2	2	2
Voltage	24 V	24 V	24 V
Current	50 mA	50 mA	50 mA
External supply voltage	24 V	24 V	24 V
Voltage tolerance	-20 %/+20 %	-20 %/+20 %	-20 %/+20 %
Relay outputs	787949	787950	787951
Number of output contacts			
Safety contacts (N/O), instantaneous	2	2	2
Auxiliary contacts (N/C)	1	1	1
Max. short circuit current IK	1 kA	1 kA	1 kA
Utilisation category			
In accordance with the standard	EN 60947-4-1	EN 60947-4-1	EN 60947-4-1
Utilisation category of safety contacts			
AC1 at	240 V	240 V	240 V
Min. current	0,01 A	0,01 A	0,01 A
Max. current	6 A	6 A	6 A
Max. power	1500 VA	1500 VA	1500 VA
DC1 at	24 V	24 V	24 V
Min. current	0,01 A	0,01 A	0,01 A
Max. current	6 A	6 A	6 A
Max. power	150 W	150 W	150 W
Utilisation category of auxiliary contacts			
AC1 at	240 V	240 V	240 V
Min. current	0,01 A	0,01 A	0,01 A
Max. current	6 A	6 A	6 A
Max. power	1500 VA	1500 VA	1500 VA
DC1 at	24 V	24 V	24 V
Min. current	0,01 A	0,01 A	0,01 A
Max. current	6 A	6 A	6 A
Max. power	150 W	150 W	150 W

Relay outputs	787949	787950	787951
Utilisation category			
In accordance with the standard	EN 60947-5-1	EN 60947-5-1	EN 60947-5-1
Utilisation category of safety contacts			
AC15 at	230 V	230 V	230 V
Max. current	3 A	3 A	3 A
DC13 (6 cycles/min) at	24 V	24 V	24 V
Max. current	4 A	4 A	4 A
Utilisation category of auxiliary contacts			
AC15 at	230 V	230 V	230 V
Max. current	3 A	3 A	3 A
DC13 (6 cycles/min) at	24 V	24 V	24 V
Max. current	4 A	4 A	4 A
Utilisation category in accordance with UL			
Voltage	240 V AC G. P.	240 V AC G. P.	240 V AC G. P.
With current	6 A	6 A	6 A
External contact fuse protection, safety contacts			
In accordance with the standard	EN 60947-5-1	EN 60947-5-1	EN 60947-5-1
Max. melting integral	66 A²s	66 A²s	66 A²s
Blow-out fuse, quick	6 A	6 A	6 A
Blow-out fuse, slow	4 A	4 A	4 A
Blow-out fuse, gG	6 A	6 A	6 A
Circuit breaker 24V AC/DC, characteristic B/C	4 A	4 A	4 A
External contact fuse protection, auxiliary contacts			
Max. melting integral	66 A²s	66 A²s	66 A²s
Blow-out fuse, quick	6 A	6 A	6 A
Blow-out fuse, slow	4 A	4 A	4 A
Blow-out fuse, gG	6 A	6 A	6 A
Circuit breaker 24 V AC/DC, characteristic B/C	4 A	4 A	4 A
Conventional thermal current	6 A	6 A	6 A
Contact material	AgCuNi + 0,2 µm Au	AgCuNi + 0,2 µm Au	AgCuNi + 0,2 µm Au

Conventional thermal current while loading several contacts	787949	787950	787951
I _{th} per contact at UB DC; AC1: 240 V, DC1: 24 V			
Conv. therm. current with 1 contact	6 A	6 A	6 A
Conv. therm. current with 2 contacts	4 A	4 A	4 A
Times	787949	787950	787951
Delay-on de-energisation			
After motor on max.	170 ms	170 ms	170 ms
Max. switch-on delay			
After motor standstill max.	1.500 ms	1.500 ms	1.500 ms
After power on max.	2.200 ms	2.200 ms	2.200 ms
Recovery time at max. switching frequency 1/s			
After motor on	2.200 ms	2.200 ms	2.200 ms
Supply interruption before de-energisation	20 ms	20 ms	20 ms
Simultaneity, channel 1 and 2 max.	7 s	7 s	7 s
Environmental data	787949	787950	787951
Climatic suitability	EN 60068-2-78	EN 60068-2-78	EN 60068-2-78
Ambient temperature			
Temperature range	-10 - 55 °C	-10 - 55 °C	-10 - 55 °C
Storage temperature			
Temperature range	-40 - 85 °C	-40 - 85 °C	-40 - 85 °C
Climatic suitability			
Humidity	93 % r. h. at 40 °C	93 % r. h. at 40 °C	93 % r. h. at 40 °C
Condensation during operation	Not permitted	Not permitted	Not permitted
EMC	EN 60947-5-1, EN 61000-6-2, EN 61000-6-4, EN 61326-3-1	EN 60947-5-1, EN 61000-6-2, EN 61000-6-4, EN 61326-3-1	EN 60947-5-1, EN 61000-6-2, EN 61000-6-4, EN 61326-3-1
Vibration			
In accordance with the standard	EN 60068-2-6	EN 60068-2-6	EN 60068-2-6
Frequency	10 - 55 Hz	10 - 55 Hz	10 - 55 Hz
Amplitude	0,35 mm	0,35 mm	0,35 mm
Airgap creepage			
In accordance with the standard	EN 60947-1	EN 60947-1	EN 60947-1
Overvoltage category	III / II	III / II	III / II
Pollution degree	2	2	2
Rated insulation voltage	690 V	690 V	690 V
Rated impulse withstand voltage	6 kV	6 kV	6 kV

Environmental data	787949	787950	787951
Protection type			
Mounting area (e.g. control cabinet)	IP54	IP54	IP54
Housing	IP40	IP40	IP40
Terminals	IP20	IP20	IP20
Mechanical data	787949	787950	787951
Mounting position	Any	Any	Any
Mechanical life	10,000,000 cycles	10,000,000 cycles	10,000,000 cycles
Material			
Bottom	PPO UL 94 V0	PPO UL 94 V0	PPO UL 94 V0
Front	ABS UL 94 V0	ABS UL 94 V0	ABS UL 94 V0
Top	PPO UL 94 V0	PPO UL 94 V0	PPO UL 94 V0
Connection type	Cage clamp terminal	Cage clamp terminal	Cage clamp terminal
Mounting type	plug-in	plug-in	plug-in
Conductor cross section with spring-loaded terminals: Flexible with/without crimp connector	0,2 - 1,5 mm², 24 - 16 AWG	0,2 - 1,5 mm², 24 - 16 AWG	0,2 - 1,5 mm², 24 - 16 AWG
Spring-loaded terminals: Terminal points per connection	2	2	2
Stripping length with spring-loaded terminals	8 mm	8 mm	8 mm
Dimensions			
Height	101 mm	101 mm	101 mm
Width	45 mm	45 mm	45 mm
Depth	121 mm	121 mm	121 mm
Weight	325 g	325 g	325 g

Where standards are undated, the 2014-07 latest editions shall apply.

Safety characteristic data



NOTICE

You must comply with the safety-related characteristic data in order to achieve the required safety level for your plant/machine.

Operating mode	EN ISO 13849-1: 2008	EN ISO 13849-1: 2008	EN 62061	EN 62061	IEC 61511	IEC 61511	EN ISO 13849-1: 2008
	PL	Category	SIL CL	PFH_D [1/h]	SIL	PFD	T_M [year]
–	PL e	Cat. 4	SIL CL 3	6,23E-09	SIL 3	6,47E-05	20

All the units used within a safety function must be considered when calculating the safety characteristic data.



INFORMATION

A safety function's SIL/PL values are **not** identical to the SIL/PL values of the units that are used and may be different. We recommend that you use the PAScal software tool to calculate the safety function's SIL/PL values.

Supplementary data



CAUTION!

It is essential to consider the relay's service life graphs. The relay outputs' safety-related characteristic data is only valid if the values in the service life graphs are met.

The PFH value depends on the switching frequency and the load on the relay output. If the service life graphs are not accessible, the stated PFH value can be used irrespective of the switching frequency and the load, as the PFH value already considers the relay's B10d value as well as the failure rates of the other components.

Service life graph

The service life graphs indicate the number of cycles from which failures due to wear must be expected. The wear is mainly caused by the electrical load; the mechanical load is negligible.

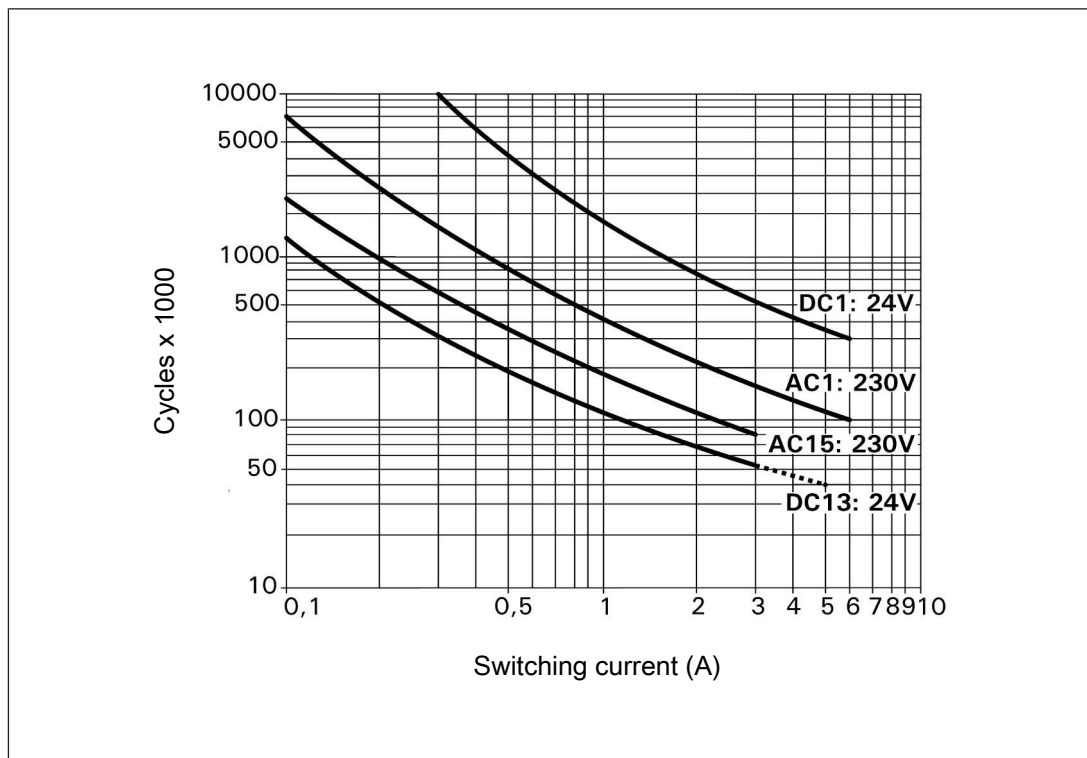

Fig.: Service life graphs at 24 VDC and 230 VAC

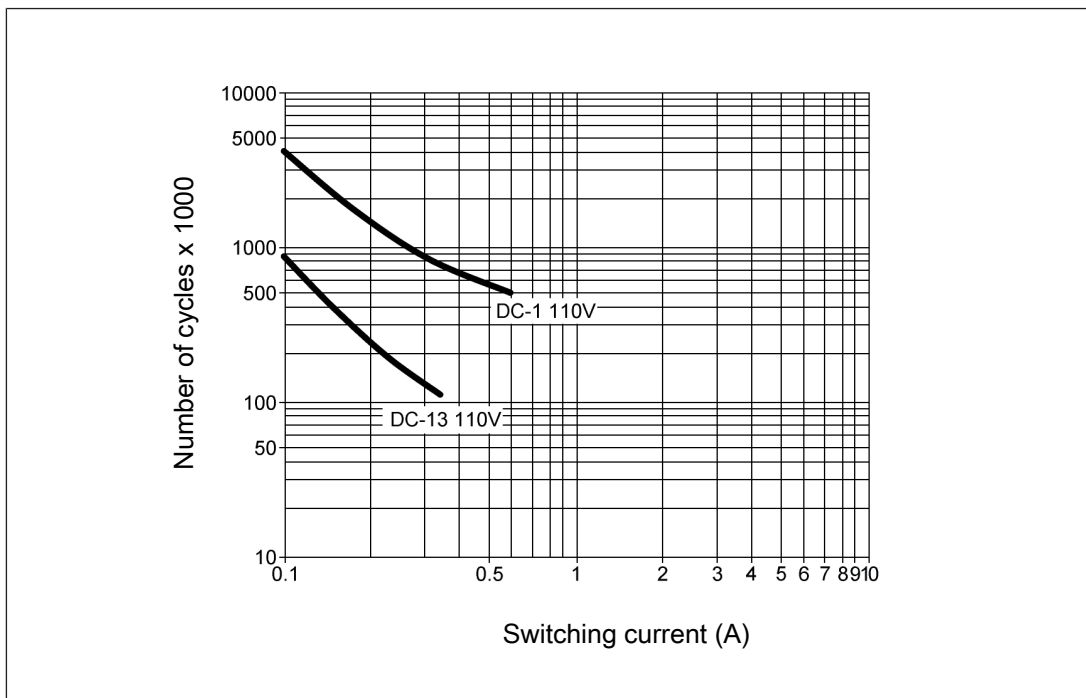

Fig.: Service life graphs at 110 VDC

Example

- ▶ Inductive load: 0.2 A
- ▶ Utilisation category: AC15
- ▶ Contact service life: 1 000 000 cycles

Provided the application to be implemented requires fewer than 1 000 000 cycles, the PFH value (see [Technical details \[18\]](#)) can be used in the calculation.

To increase the service life, sufficient spark suppression must be provided on all relay contacts. With capacitive loads, any power surges that occur must be noted. With DC contactors, use flywheel diodes for spark suppression.

Order reference

Type	Features	Connection type	Order no.
PSWZ X1P C	24 - 240 V AC/DC; 0,02 - 0,5 V; U_{on} : 20 - 500 mV	Spring-loaded terminal	787 949
PSWZ X1P	24 - 240 V AC/DC; 0,02 - 0,5 V; U_{on} : 20 - 500 mV	Screw terminals	777 949
PSWZ X1P C	24 - 240 V AC/DC; 0,12 - 3 V; U_{on} : 120 - 3000 mV	Spring-loaded terminal	787 950
PSWZ X1P	24 - 240 V AC/DC; 0,12 - 3 V; U_{on} : 120 - 3000 mV	Screw terminals	777 950
PSWZ X1P C	24 - 240 V AC/DC; 0,0075 - 0,5 V; U_{on} : 7.5 - 500 mV	Spring-loaded terminal	787 951
PSWZ X1P	24 - 240 V AC/DC; 0,0075 - 0,5 V; U_{on} : 7.5 - 500 mV	Screw terminals	777 951

Type	Features	Connection type	Order no.
PSWZ X1P (coated version)	24 - 240 V AC/DC; 0,02 - 0,5 V; U_{on} : 20 - 500 mV	Screw terminals	777 959

Selection guide: Determine remanence voltage

The remanence voltage has to be within the response range of the device.

EC declaration of conformity

This product/these products meet the requirements of the directive 2006/42/EC for machinery of the European Parliament and of the Council. The complete EC Declaration of Conformity is available on the Internet at www.pilz.com/support/downloads.

Representative: Norbert Fröhlich, Pilz GmbH & Co. KG, Felix-Wankel-Str. 2, 73760 Ostfildern, Germany

► Support

Technical support is available from Pilz round the clock.

Americas

Brazil

+55 11 97569-2804

Canada

+1 888-315-PILZ (315-7459)

Mexico

+52 55 5572 1300

USA (toll-free)

+1 877-PILZUSA (745-9872)

Asia

China

+86 21 60880878-216

Japan

+81 45 471-2281

South Korea

+82 31 450 0680

Australia

+61 3 95446300

Europe

Austria

+43 1 7986263-0

Belgium, Luxembourg

+32 9 3217575

France

+33 3 88104000

Germany

+49 711 3409-444

Ireland

+353 21 4804983

Italy

+39 0362 1826711

Scandinavia

+45 74436332

Spain

+34 938497433

Switzerland

+41 62 88979-30

The Netherlands

+31 347 320477

Turkey

+90 216 5775552

United Kingdom

+44 1536 462203

You can reach our international hotline on:

+49 711 3409-444

support@pilz.com

Pilz develops environmentally-friendly products using ecological materials and energy-saving technologies. Offices and production facilities are ecologically designed, environmentally-aware and energy-saving. So Pilz offers sustainability, plus the security of using energy-efficient products and environmentally-friendly solutions.

Energy saving by Pilz



Pilz GmbH & Co. KG
Felix-Wankel-Straße 2
73760 Ostfildern, Germany
Tel.: +49 711 3409-0
Fax: +49 711 3409-133
info@pilz.com
www.pilz.com

PILZ
THE SPIRIT OF SAFETY