

THIRD ANGLE PROJECTION

ALL DIMENSIONS IN MM IF IN DOUBT ASK

TOLERANCE UNLESS OTHERWISE STATED		
GENERAL TOLERANCE		
NO DECIMAL PLACE	±	0.5mm
ONE DECIMAL PLACE	±	0.3mm
TWO DECIMAL PLACES	±	0.1mm
ANGLES	±	1°

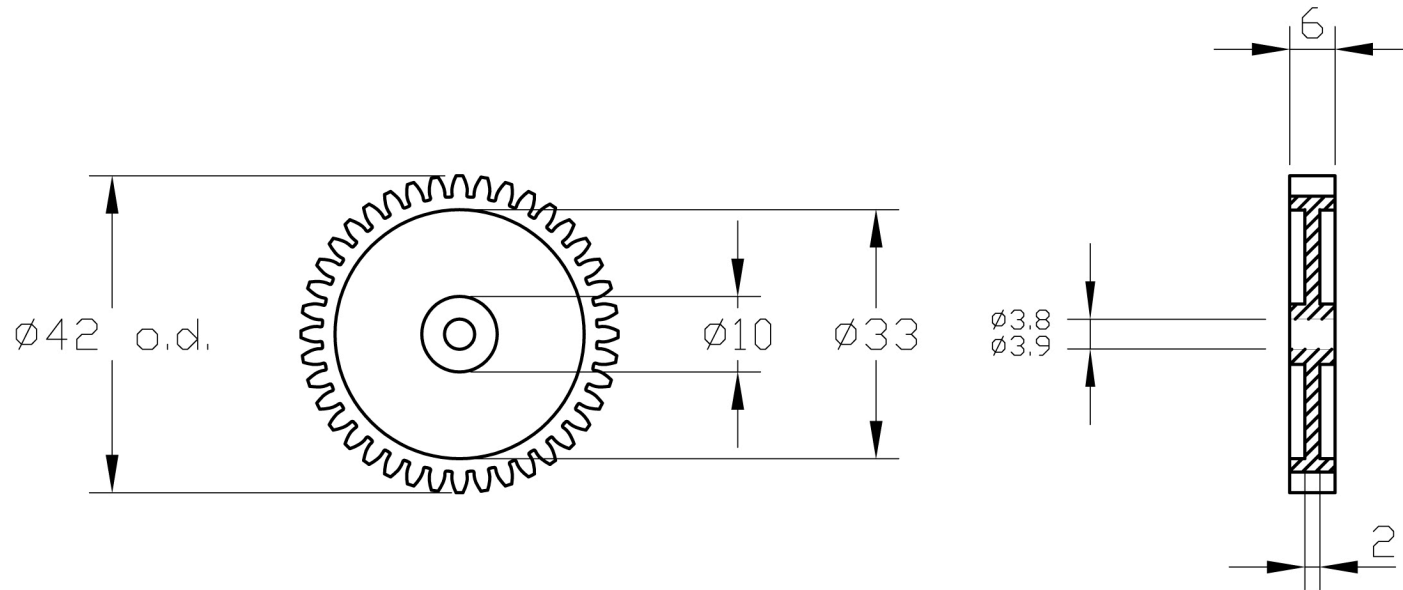

$\phi 40$ PCD
1 module

19/06/02	1
Date	Issue

DESCRIPTION :	40T Gear
PROD Code:	4040
PART No.:	4040
DRAWING No. :	

MATERIAL :	Polypropelene	drawn	checked	date
SCALE :	FINISH : Red			19/06/02