



Mueller clips are the industry standard. Our designs □
 reflect over 100 years of innovation and improvement. □
 Mueller clips assure teeth that bite, springs that hold, □
 plating that lasts and insulators that protect.

Color Key		
0=Black	4=Yellow	6=Blue
2=Red	5=Green	9=White

Miniature Alligator

Model # BU-30/BU-30C

Solder or crimp connection
 Jaw opens 0.188" (4.8 mm) max

Material: nickel-plated steel (BU-30)
 or solid copper (BU-30C)

Length: 1.1" (27.78mm)

Federal Spec: CID AA59466-001
 (BU-30C)

Rating: 5 Amps

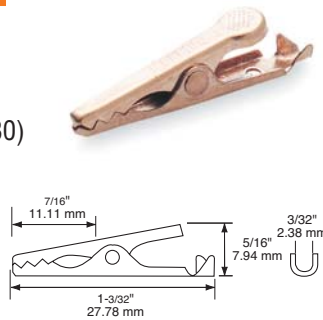

Miniature Alligator with Barrel

Model # BU-30BL

Solder or crimp connection
 Jaw opens 0.188" (4.8 mm) max

Material: nickel-plated steel

Length: 1.25" (31.75mm)

Rating: 5 Amps

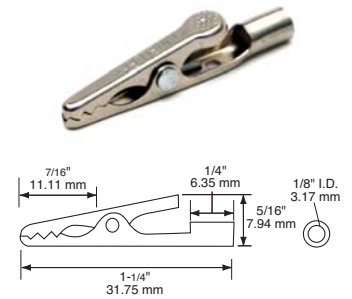

Insulator for Miniature Alligator

Model # BU-32-*

Protective flexible vinyl insulator for 30, 30C

Material: PVC

Length: 1.63" (41.28mm)

***Std. Colors:** -0 Black, -2 Red,
 -4 Yellow, -5 Green, -6 Blue, -9 White

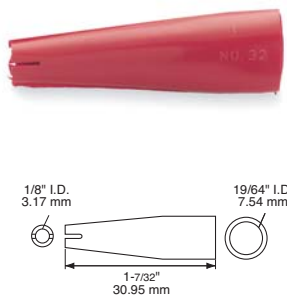

Miniature Alligator with Threaded Barrel

Model # BU-30TBO

6-32 threaded steel barrel connection

Jaw opens 0.188" (4.8 mm) max

Material: nickel-plated steel

Length: 1.5" (38.75mm)

Rating: 5 Amps



Insulator for Mini Alligator Barrel/Threaded Barrel

Model # BU-31-*

Protective flexible vinyl insulator for 30BL, 30TBO

Material: PVC

Length: 1.63" (41.28mm)

***Std. Colors:** -0 Black, -2 Red, -4 Yellow, -5 Green, -6 Blue, -9 White

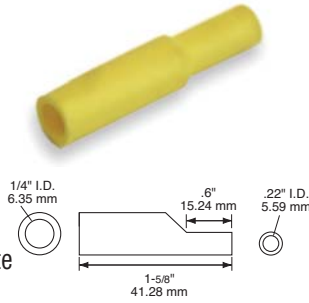

Micro-Alligator

Model # BU-34/BU-34C

Solder or crimp connection

Jaw opens 0.22" (5.6 mm) max

Material: nickel-plated steel (BU-34) or solid copper (BU-34C)

Length: 1.09" (27.78mm)

Rating: 5 Amps

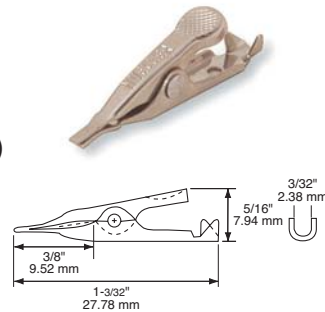

Insulator for Micro Alligator

Model # BU-36-*

Protective flexible vinyl insulator for 34, 34C

Material: PVC

Length: 1.22" (30.95mm)

***Std. Colors:** -0 Black, -2 Red, -4 Yellow, -5 Green, -6 Blue, -9 White



Alligator Clip with Barrel

Model # BU-60/BU-60C/BU-60X

Compatible with all shrouded, unshrouded, or retractable 0.16" (4mm) banana plugs

Solder or crimp connection

Jaw opens 0.31" (7.9 mm) max

Material: nickel-plated steel (BU-60), solid copper (BU-60C), solid stainless steel (BU-60X)

Length: 1.97" (50mm)

Rating: 10 Amps

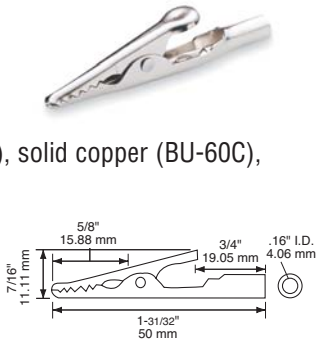

Alligator Clip with Screw

Model # BU-60S/BU-60CS

Compatible with all shrouded, unshrouded, or retractable 0.16" (4mm) banana plugs

6-40 screw connection

Jaw opens 0.31" (7.9 mm) max

Material: nickel-plated steel (BU-60S) or solid copper (BU-60CS)

Length: 1.97" (50mm)

Federal Spec: CID AA59466-002 (BU-60CS)

Rating: 10 Amps

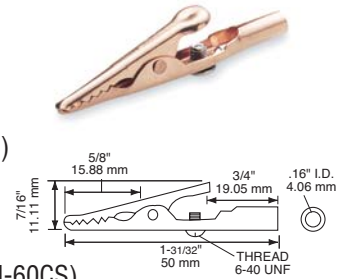

Phone Tip Alligator Clip

Model # BU-60PR2

Accepts standard phone tip or test prod tip

Jaw opens 0.31" (7.9 mm) max

Material: nickel-plated steel

Length: 1.97" (50mm)

Rating: 10 Amps

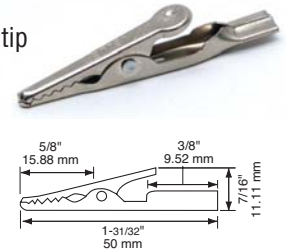

Threaded Barrel Alligator Clip

Model # BU-60TBO

8-32 threaded barrel connection

Jaw opens 0.31" (7.9 mm) max

Material: nickel-plated steel

Length: 2.13" (53.97mm)

Rating: 10 Amps



Alligator Clip

Model # BU-60U

Solder or crimp connection

Jaw opens 0.31" (7.9 mm) max

Material: nickel-plated steel

Length: 1.97" (50mm)

Rating: 10 Amps

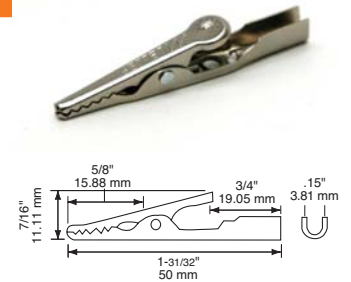

Alligator Clip with Cage Spring Barrel

Model # BU-61

Cage spring connection accepts standard prod needle (0.080 dia.)

Jaw opens 0.31" (7.9 mm) max

Material: nickel-plated steel clip, nickel-plated brass insert, gold plated beryllium copper cage spring

Length: 2.03" (51.59mm)

Rating: 10 Amps

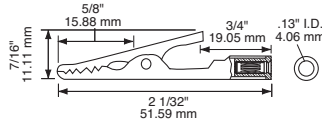

Insulator for Alligator Clips

Model # BU-62-*

Protective flexible vinyl insulator for 60, 60C, 60CS, 60PR2, 60S, 60TBO, 60U, 60X and 61

Material: PVC

Length: 2.03" (51.59mm)

***Std. Colors:** -0 Black, -2 Red, -4 Yellow, -5 Green, -6 Blue, -9 White

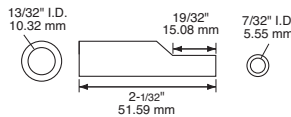

Alligator Clip with Acetate Handle

Model # BU-60H-*

Compatible with all shrouded, unshrouded, or retractable 0.16" (4mm) banana plugs

Jaw opens 0.31" (7.9 mm) max

Material: nickel-plated steel clip; tenite acetate insulated handle

Length: 2.23" (56.75mm)

***Std. Colors:** -0 Black, -2 Red, -4 Yellow, -5 Green, -6 Blue, -9 White

Rating: 10 Amps

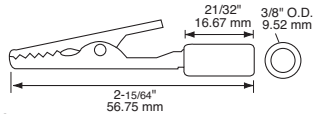

Alligator Clip with Acetate Handle and Screw

Model # BU-60HS-*/BU-60CHS-*

Compatible with all shrouded, unshrouded, or retractable 0.16" (4mm) banana plugs

Jaw opens 0.31" (7.9 mm) max

Material: nickel-plated steel (BU-60HS-*) or solid copper (BU-60CHS-*) clip; tenite acetate insulated handle

Length: 2.34" (59.53mm)

***Std. Colors:** -0 Black, -2 Red, -4 Yellow, -5 Green, -6 Blue, -9 White

Federal Spec: AA59466-003 (red), AA59466-016 (black), (BU-60CHS-*)

Rating: 10 Amps

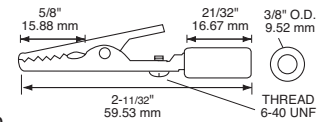

Phone Tip Alligator Clip with Acetate Handle

Model # BU-60HPR-*

Accepts standard phone tip or test prod tip

Material: nickel-plated steel clip; tenite acetate insulated handle

Length: 2.23" (56.75mm)

***Std. Colors:** -0 Black, -2 Red, -4 Yellow, -5 Green, -6 Blue, -9 White

Rating: 10 Amps

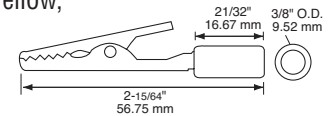

Insulated Alligator Clip

Model # BU-63-*/BU-63C-*

BU-63-* same as BU-60S and includes a skin-tight, two-piece, flexible insulator

BU-63C-* same as BU-60CS and includes a skin-tight, two piece, flexible insulator

Compatible with all shrouded, unshrouded, or retractable 0.16" (4mm) banana plugs

Material: nickel-plated steel (BU-63-*) or solid copper (BU-63C-*); PVC insulator

Length: 2.25" (57.15mm)

***Std. Colors:** -0 Black, -2 Red, -4 Yellow, -5 Green, -6 Blue, -9 White

Rating: 10 Amps

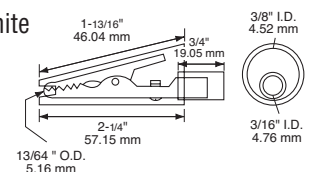

Alligator Clip

Model # BU-70/BU-70C

Solder or crimp connection
Jaw opens 0.313" (7.9 mm) max

Material: nickel-plated steel (BU-70) or solid copper (BU-70C)

Length: 1.69" (42.86mm)

Rating: 5 Amps (BU-70) or 10 Amps (BU-70C)

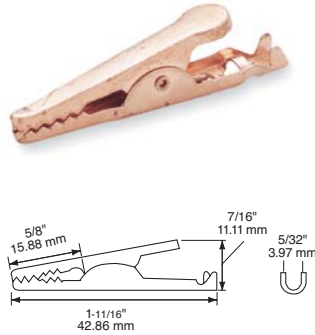

Alligator Clip with Screw

Model # BU-70S/BU-70CS

6-40 screw or crimp connection
Jaw opens 0.313" (7.9 mm) max

Material: nickel-plated steel (BU-70S) or solid copper (BU-70CS)

Length: 1.69" (42.86mm)

Federal Spec: AA59466-0017 (BU-70CS-*)

Rating: 5 Amps (BU-70S) or 10 Amps (BU-70CS)

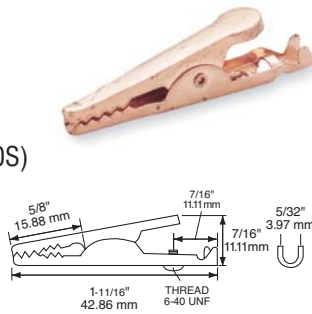

Insulator for Alligator Clip

Model # BU-72-*

Protective flexible vinyl insulator for 70, 70C, 70CS, 70S

Material: PVC

Length: 1.81" (46.04mm)

*Std. Colors: -0 Black, -2 Red, -4 Yellow, -5 Green, -6 Blue, -9 White

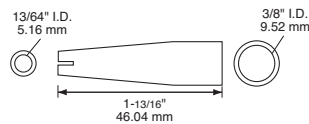

Crocodile Clip

Model # BU-85/BU-85C

Crimp or screw connection
Jaw opens 0.313" (7.9 mm) max

Nesting teeth provide solid contact along entire length of jaw

Material: zinc-plated steel (BU-85) or solid copper (BU-85C)

Length: 2.125" (53.97mm)

Federal Spec: AA59466-005 (BU-85C)

Rating: 5 Amps (BU-85) or 10 Amps (BU-85C)

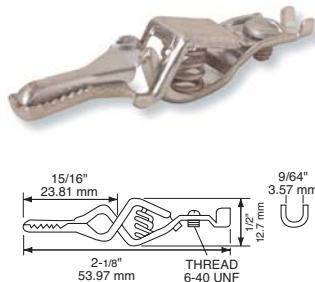

Insulator for Crocodile Clip

Model # BU-87-*

Protective flexible vinyl insulator for 85, 85C

Material: PVC

Length: 1.7" (43.26mm)

*Std. Colors: -0 Black, -2 Red, -4 Yellow, -5 Green, -6 Blue, -9 White

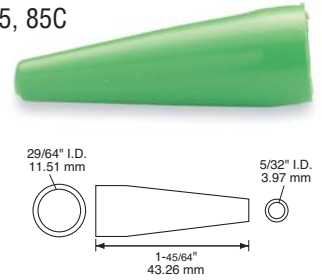

Small Safety Alligator Clip

Model # BU-651-*

Compatible with all shrouded, unshrouded, or retractable 0.16" (4mm) banana plugs

Jaw opens 0.27" (7 mm) max

Material: nickel-plated steel clip, glass-filled nylon housing

Length: 2.24" (57mm)

*Std. Colors: -0 Black, -2 Red

Rating: 1000 V category II, 600V category III, 20 Amps, IEC 1010 Compliant



Small Safety Alligator Clip with Extended Banana Jack

Model # BU-652-*

Compatible with all shrouded, unshrouded, or retractable 0.16" (4mm) banana plugs

Jaw opens 0.27" (7 mm) max

Material: nickel-plated steel clip, glass-filled nylon housing

Length: 3.24" (82mm)

*Std. Colors: -0 Black, -2 Red

Rating: 1000 V category II, 600V category III, 20 Amps, IEC 1010 Compliant



Large Safety Alligator Clip

Model # BU-65-*

Compatible with all shrouded, unshrouded, or retractable 0.16" (4mm) banana plugs

Jaw opens 0.75" (19 mm) max

Material: nickel-plated steel clip, glass-filled nylon housing

Length: 3.23" (82.04mm)

*Std. Colors: -0 Black, -2 Red, -4 Yellow, -6 Blue

Rating: 1000 V, 30 Amps, IEC 1010 Compliant



Large Flanged Safety Alligator Clip

Model # BU-654-*

Compatible with all shrouded, unshrouded, or retractable 0.16" (4mm) banana plugs

Jaw opens 1.00" (26 mm) max

Material: nickel-plated steel clip, glass-filled nylon housing

Length: 3.19" (81mm)

***Std. Colors:** -0 Black, -2 Red

Rating: 1000 V category II, 600V category III, 20 Amps, IEC 1010 Compliant



Pee-Wee Clip

Model # BU-45/BU-45C

Screw or crimp connection

Jaw opens 0.31" (7.9 mm) max

Material: zinc-plated steel (BU-45) or solid copper (BU-45C)

Length: 1.53" (38.89mm)

Federal Spec: CID AA59466-006 (BU-45C)

Rating: 5 Amps (BU-45) or 10 Amps (BU-45C)

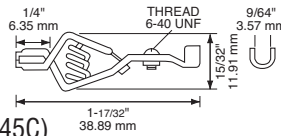

Insulator for Pee-Wee Clip

Model # BU-47-*

Protective flexible vinyl insulator for 45, 45C

Material: PVC

Length: 2.02" (51.2 mm)

***Std. Colors:** -0 Black, -2 Red, -4 Yellow, -5 Green, -6 Blue, -9 White

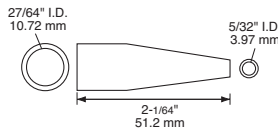

Economy Clip

Model # BU-55

Screw or crimp connection

Jaw opens 0.44" (11.1 mm) max

Material: zinc-plated steel

Length: 2" (50.8mm)

Rating: 10 Amps

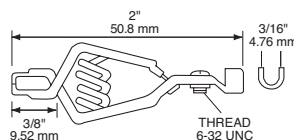

Insulator

Model # BU-74-*

Protective flexible vinyl insulator for 55

Accepts 0.27" (7 mm) ignition wire

Material: PVC

Length: 2.875" (73mm)

***Std. Colors:** -0 Black, -2 Red, -4 Yellow, -5 Green, -6 Blue, -9 White

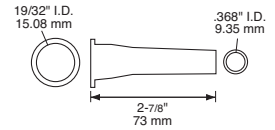

Automotive Analyzer Clip

Model # BU-48B/BU-48C

Screw or crimp connection

Jaw opens 0.5" (12.7 mm) max

Teeth mesh on three sides of the jaw

Material: zinc-plated steel (BU-48B) or solid copper (BU-48C)

Length: 2" (50.8mm)

Federal Spec: CID AA59466-007 (BU-48C)

Rating: 10 Amps (BU-48B) or 20 Amps (BU-48C)

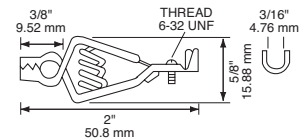

Automotive Analyzer Clip

Model # BU-48B2E

Screw or double crimp connection

Jaw opens 0.5" (12.7 mm) max

Material: zinc-plated steel

Length: 2" (50.8mm)

Rating: 10 Amps

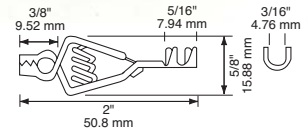

Meter Testing Clip With Needle

Model # BU-50C

Solid copper clip with beryllium copper piercing needle in the top jaw

Jaw opens 0.5" (12.7 mm) max

Material: Solid copper

Length: 2.28" (57.12mm)

Federal Spec: CID AA59466-013

Rating: 20 Amps

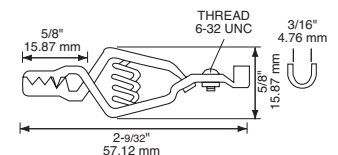

Meter Testing Clip

Model # BU-51C

Same as BU-50C except without insulation piercing needle

Jaw opens 0.5" (12.7 mm) max

Material: Solid copper

Length: 2.28" (57.12mm)

Rating: 20 Amps

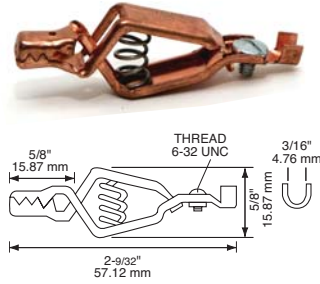

Insulator for Automotive Analyzer Clip

Model # BU-49-*

Protective flexible vinyl insulator for 48B, 48B2E, 48C, 50C, 51C, 55, 95

Material: PVC

Length: 2.56" (65.09mm)

*Std. Colors: -0 Black, -2 Red, -4 Yellow, -5 Green, -6 Blue, -9 White

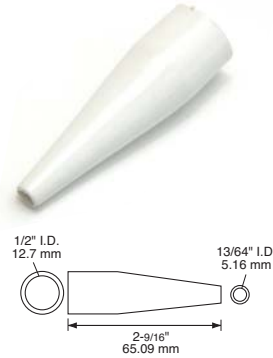

General Purpose Clip

Model # BU-27/BU-27C

Crimp or screw connection; jaw opens 0.625" (16 mm) max

Material: zinc-plated steel (BU-27) or solid copper (BU-27C); *Spring:* steel

Length: 2.44" (61.9mm)

Federal Spec: CID AA59466-008 (BU-27C)

Rating: 20 Amps (BU-27) or 40 Amps (BU-27C)

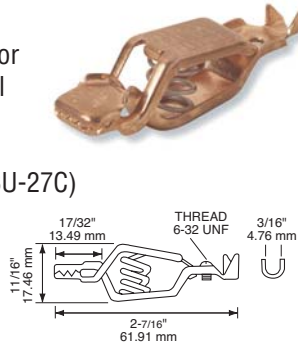

Geophone Clip

Model # BU-27CG/BU-27CGW

Crimp or screw connection; jaw opens 0.625" (16 mm) max; curved jaws clip on to seismograph rings

Material: solid copper; *Spring:* steel

Length: 2.4" (61.1mm)

Rating: 40 Amps

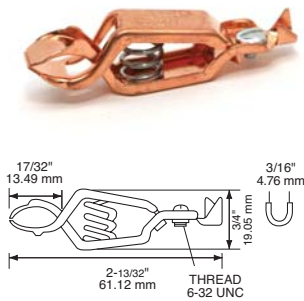

General Purpose/Geophone Clips

Model # BU-29-*

Protective flexible vinyl insulator for 27, 27C, 27CG, 27CGW

Material: PVC

Length: 3.5" (88.9mm)

*Std. Colors: -0 Black, -2 Red, -4 Yellow, -5 Green, -6 Blue, -9 White



Insulator for General Purpose/Geophone Clips

Model # BU-90-*

Protective flexible vinyl insulator for 27, 27C, 27CG and 27CGW

Accepts larger wires or cables than BU-29-*

Material: PVC

Length: 3.375" (92mm)

*Std. Colors: -0 Black, -2 Red, -4 Yellow, -5 Green, -6 Blue, -9 White

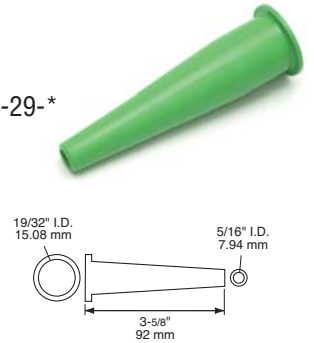

Heavy Duty Clip

Model # BU-24APN/BU-24APS

Crimp or screw connection; jaw opens 0.75" (19 mm) max; clip unmarked (BU-24APN) and marked positive (BU-24APS)

Material: zinc-plated steel; *Spring:* steel

Length: 2.84" (72.23mm)

Rating: 25 Amps

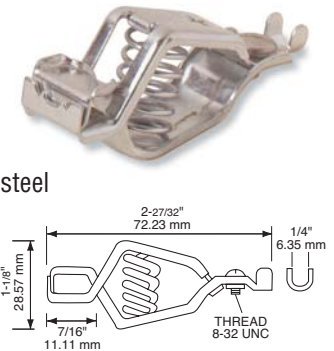

Automotive Clip

Model # BU-25/BU-25C

Crimp or screw connection; jaw opens 0.75" (19 mm) max; teeth mesh on three sides of the jaw

Material: zinc-plated steel (BU-25) or solid copper (BU-25C); *Spring:* steel

Length: 3" (72.6mm)

Federal Spec: CID AA59466-009 (BU-25C)

Rating: 40 Amps (BU-25) or 75 Amps (BU-25C)

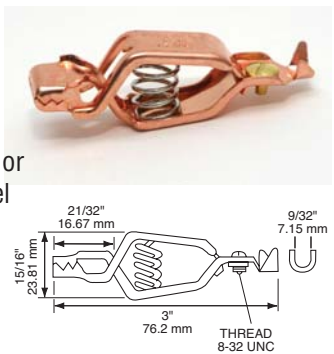

Insulator for Automotive Clip

Model # BU-26-*

Protective flexible vinyl insulator for 24A, 25, 25C

Material: PVC

Length: 3.88" (98.4 mm)

***Std. Colors:** -0 Black, -2 Red, -4 Yellow, -5 Green, -6 Blue, -9 White

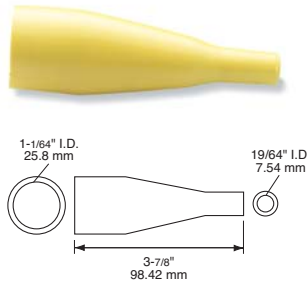

Heavy Duty Clip for Battery and Test Work

Model # BU-21APN/BU-21APS/BU-21CPN/BU-21CPS

Crimp or screw connection; copper version (21C) equipped with removable copper lug; jaw opens 1.06" (27 mm) max; clip unmarked (BU-21APN/CPN) and marked positive (BU-21APS/CPS)

Material: zinc-plated steel (21A) or solid copper (21C); *Spring:* steel

Length: 4.11" (104.4mm)

Federal Spec: CID AA59466-010 (BU-21CPN)

Rating: 50 Amps (21A) or 100 Amps (21C)

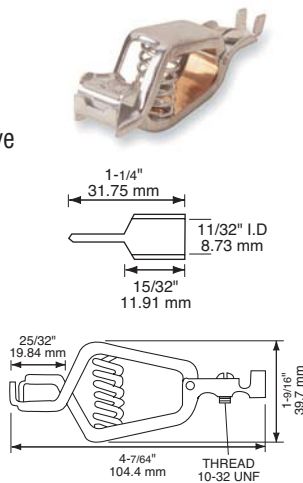

Insulator for Heavy Duty Battery Test Clip

Model # BU-23-*

Protective flexible vinyl insulator for 21A, 21C

Material: PVC

Length: 5" (127mm)

***Std. Colors:** -0 Black, -2 Red, -4 Yellow, -5 Green, -6 Blue, -9 White



Heavy Duty Clip for Grounding Applications

Model # BU-11APN/BU-11APS/BU-11CPN/BU-11CPS

Copper version has a lug connection

Jaw opens 1.625" (41.3 mm) max

Clip unmarked (BU-11APN/CPN) and marked positive (BU-11APS/CPS)

Material: zinc-plated steel (11A) or solid copper (11C); *Spring:* steel

Length: 6" (152.4 mm)

Federal Spec: CID AA59466-011 (BU-11CPN)

Rating: 100 Amps (11A) or 200 Amps (11C)

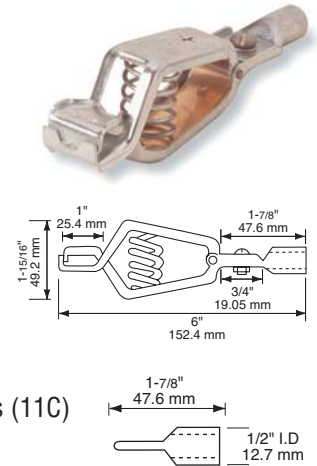

Insulator for Heavy Duty Clip

Model # BU-13-*

Protective flexible vinyl insulator for 11A, 11C

Material: PVC

Length: 6.8" (173mm)

***Std. Colors:** -0 Black, -2 Red, -4 Yellow, -5 Green, -6 Blue, -9 White



Welding Clip

Model # BU-33C

Lug connection

Jaw opens 1.81" (46 mm) max

Material: solid copper

Length: 7.75" (196.8mm)

Federal Spec: CID AA59466-012

Rating: 300 Amps

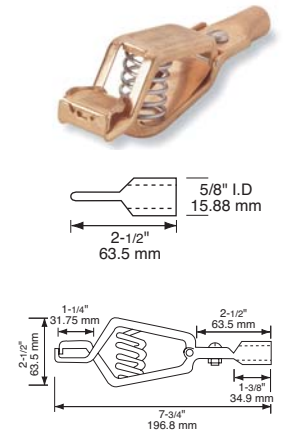

Insulator for Welding Clip

Model # BU-35-*

Protective flexible vinyl insulator for 33C

Material: PVC

Length: 8.75" (222mm)

***Std. Colors:** -0 Black, -2 Red,



Grounding Clamp

Model # BU-58

Attaches to pipe up to 1 3/8" outer diameter

Material: zinc-plated steel

Length: 2.31" (58.75mm)

Rating: 50 Amps



Micro Plier-Type Clip

Model # BU-40A-*/BU-40C-*

Solder or crimp connection

Jaw opens 0.75" (19 mm) max

Material: nickel-plated steel (BU-40A) or solid copper (BU-40C), PVC insulator (BU-42PR-*)

Length: 2.3" (58mm)

***Std. Colors:** Insulator (BU-42PR-*) -0 Black, -2 Red, -4 Yellow, -5 Green, -6 Blue, -9 White

Rating: 15 Amps (BU-40A), 20 Amps (BU-40C)



Insulator for Micro Plier-Type Clip

Model # BU-42PR-*

Protective flexible vinyl insulator for BU-40

Material: PVC

Length: 1" (25.4mm)

***Std. Colors:** -0 Black, -2 Red, -4 Yellow, -5 Green, -6 Blue, -9 White



Miniature Plier-Type Clip

Model # BU-46A-*/BU-46C-*

Solder or crimp connection

Jaw opens 1.125" (28.6 mm) max

Material: copper-plated steel (BU-46A) or solid copper (BU-46C), PVC insulator (BU-46PR-*)

Length: 2.88" (98.42mm)

***Std. Colors:** Insulator (BU-46PR-*) in -0 Black, -2 Red

Rating: 50 Amps (46A) or 75 Amps (46C)

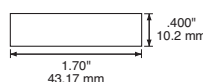
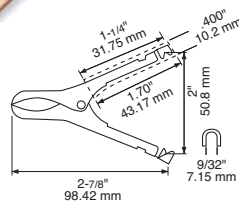

Insulator for Miniature Plier-Type Clip

Model # BU-46PR-*

Protective flexible vinyl insulator for BU-46

Material: PVC

Length: 1.7" (43.18mm)

***Std. Colors:** -0 Black, -2 Red,



Plier-Type Clip

Model # BU-41A-*/BU-41APN/BU-41C-*/BU-41CPN

Jaw opens 1.625" (41.3 mm) max

Locks on to both side and top mounted battery terminals

Material: copper-plated steel (BU-41A) or solid copper (BU-41C), PVC insulator (BU-43PR-*)

Length: 6" (152mm)

***Std. Colors:** Insulator (BU-43PR-*) in -0 Black, -2 Red, -4 Yellow, -5 Green, -6 Blue, -9 White

Federal Spec: CID AA59466-014 BU-41-CPS-VZZZ-2 (red) and CID AA59466-015, BU-41CPN-VZZZ-0 (black)

Rating: 200 Amps (41A) or 400 Amps (41C)

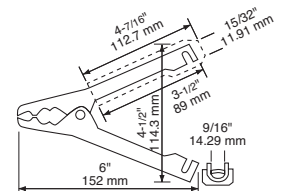
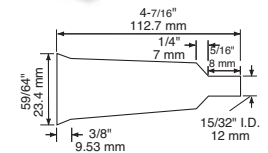

Insulator for Plier-Type Clip

Model # BU-43PR-*

Protective flexible vinyl insulator for BU-41

Material: PVC

Length: 4.4" (112.73mm)

***Std. Colors:** -0 Black, -2 Red, -4 Yellow, -5 Green, -6 Blue, -9 White



Insulated Battery Clip

Model # BU-102B-*/BU-102BK-*

Fully insulated clip with serrated jaws; BU-102BK-* has Kelvinized isolated jaws and no copper shunt

Material: *Housing:* glass filled nylon; *Jaw:* copper; *Spring:* music wire, zinc plated

Length: 6.5" (165mm)

***Std. Colors:** -0 Black, -2 Red

Rating: 300 Amps



Insulated Welding Clip

Model # BU-102W-*

Fully insulated clip with serrated contact pad and braided copper shunt

Material: *Housing:* glass filled nylon;
Jaw: copper; *Spring:* music wire, zinc plated

Length: 6.5" (165mm)

***Std. Colors:** -0 Black, -2 Red

Rating: 400 Amps



Epoxy Coated Battery Clip

Model # BU-X15400-*

Jaw opens 1.50" (38.1 mm) max

Locks on to both side and top mounted battery terminals

Material: steel, epoxy coated clips with copper plated jaws

Length: 6.75" (171.45mm)

***Std. Colors:** -0 Black, -2 Red

Rating: 200 Amps



Kelvin Clip

Model # BU-75K

Jaw opens 0.313" (7.9 mm) max

Isolated jaws

Material: Silver/Gold tip contacts, nylon housing

Length: 1.625" (41.28mm)

Rating: 10 Amps

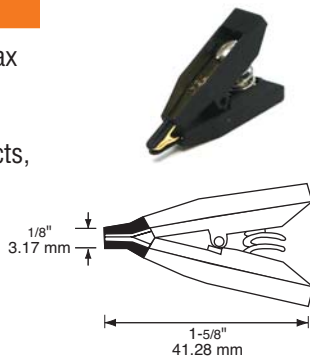

Kelvin Clip

Model # BU-78K

Jaw opens 0.5" (12 mm) max

Isolated jaws

Material: Gold contacts

Length: 2.28" (57.91mm)

Rating: 10 Amps

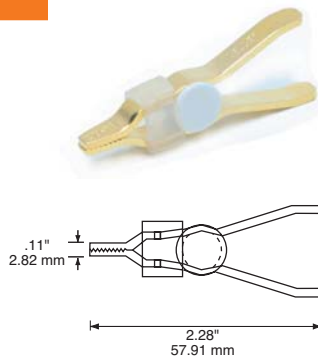

Small Angled Nose Telecom Clip with Bed of Nails

Model # JP-25182-***

Mueller – J.S. Popper brand

Jaw opens 1.0" (25.4mm)

Uses bed of nails to pierce insulation

Material: nickel-silver jaws; includes brass screw, brass nut, brass washer, and bronze star washer

Length: 2.34" (59.4mm)

Connection Options: -N Without Hardware, -L With Loose Hardware, -J Banana Jack, -TJ Threaded Banana Jack

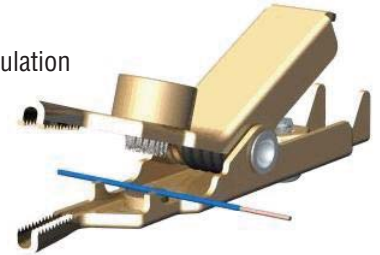

Large Angled Nose Telecom Clip with Single Spike

Model # JP-8099-***

Mueller – J.S. Popper brand

Jaw opens 1.0" (25.4mm)

Uses single spike to pierce insulation

Material: nickel-silver jaws; includes brass screw, brass nut, brass washer, and bronze star washer

Length: 2.61" (66.4mm)

Connection Options: -N Without Hardware, -L With Loose Hardware, -J Banana Jack, -TJ Threaded Banana Jack



Large Angled Nose Telecom Clip with Hex Screw Attached Single Spike

Model # JP-8078-***

Mueller – J.S. Popper brand

Jaw opens 1.0" (25.4mm)

Uses single spike to pierce insulation

Material: nickel-silver jaws; includes brass screw, brass nut, brass washer, and bronze star washer

Length: 2.61" (66.4mm)

Connection Options: -N Without Hardware, -L With Loose Hardware, -J Banana Jack, -TJ Threaded Banana Jack



Large Angled Nose Telecom Clip with Bed of Nails and Single Spike

Model # JP-8783-***

Mueller – J.S. Popper brand

Jaw opens 1.0" (25.4mm)

Uses single spike and bed of nails to pierce insulation

Material: nickel-silver jaws; includes brass screw, brass nut, brass washer, and bronze star washer

Length: 2.61" (66.4mm)

Connection Options: -N Without Hardware, -L With Loose Hardware, -J Banana Jack, -TJ Threaded Banana Jack



Large Straight Nose Telecom Clip with Single Spike

Model # JP-33699-***

Mueller – J.S. Popper brand

Jaw opens 1.0" (25.4mm)

Uses single spike to pierce insulation

Material: nickel-silver jaws; includes brass screw, brass nut, brass washer, and bronze star washer

Length: 2.61" (66.4mm)

Connection Options: -N Without Hardware, -L With Loose Hardware, -J Banana Jack, -TJ Threaded Banana Jack

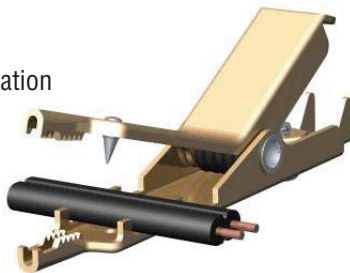

Large Straight Nose Telecom Clip with Bed of Nails and Single Spike

Model # JP-33674-***

Mueller – J.S. Popper brand

Jaw opens 1.0" (25.4mm)

Uses single spike and bed of nails to pierce insulation

Material: nickel-silver jaws; includes brass screw, brass nut, brass washer, and bronze star washer

Length: 2.61" (66.4mm)

Connection Options: -N Without Hardware, -L With Loose Hardware, -J Banana Jack, -TJ Threaded Banana Jack

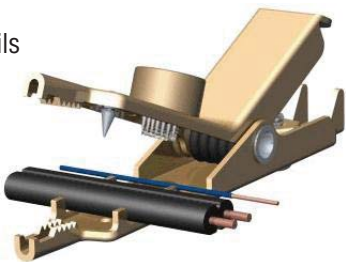

Contact Clip with Bed of Nails

Model #JP-5869-B

Mueller – J.S. Popper brand

Jaw opens 0.52" (13.2mm)

Uses bed of nails to pierce insulation

Material: steel

Length: 2.4" (61.0mm)



Contact Clip with Circle of Nails

Model # JP-5869-C

Mueller – J.S. Popper brand

Jaw opens 0.52" (13.2mm)

Uses circle of points to pierce insulation

Material: steel

Length: 2.4" (61.0mm)



Insulator for Telecom Clips

Model # JP-8681-*

Mueller – J.S. Popper brand

Protective flexible vinyl insulator for 25182, 8099, 8078, 8783, 33699, 33674

Material: PVC

Length: 2.4" (61.0mm)

***Std. Colors:** -0 Black, -2 Red, -4 Yellow, -5 Green, -6 Blue, -9 White

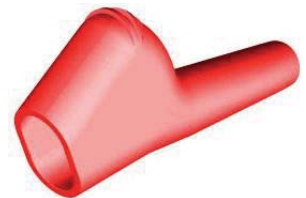

Cut Insulator for Telecom Clips

Model # JP-8681-C*

Mueller – J.S. Popper brand

Protective flexible vinyl insulator for telecom clips with banana jack or threaded banana jack connections

Material: PVC

Length: 1.8" (45.7mm)

***Std. Colors:** -0 Black, -2 Red, -4 Yellow, -5 Green, -6 Blue, -9 White

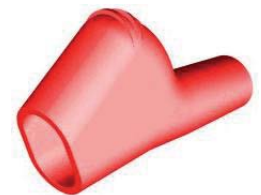



Mueller's jacks, binding posts and banana plugs ensure a reliable connection. All plug bodies are nickel-plated brass. Shielded jacks provide additional user safety where it is required.

Color Key		
0=Black	4=Yellow	6=Blue
2=Red	5=Green	9=White

Banana Plug With 8-32 Thread

Model # BU-00226-*

Nine leaf cage spring 4mm banana plug

Material: *Banana Plug:* nickel-plated brass body; *Spring:* nickel-plated phosphor bronze; *Insulator:* ABS

Length: 1.66" (42.13mm)

***Std. Colors:** -0 Black, -2 Red

Rating: 1000 Volts, 15 Amps (hands free)

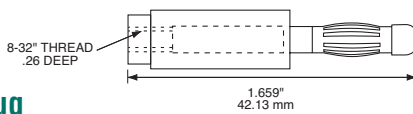

Threaded Banana Plug

Model # BU-00241

Material: *Banana Plug:* nickel-plated brass body; *Spring:* nickel-plated phosphor bronze

Length: 1.21" (31mm)

Rating: 15 Amp



Solderless Banana Plug

Model # BU-00243-*

Material: *Banana Plug:* nickel-plated brass body; *Spring:* nickel-plated phosphor bronze; *Insulator:* ABS

Length: 1.1" (28mm)

***Std. Colors:** -0 Black, -2 Red

Rating: 15 Amp



Solderless Banana Plug-Hex Design

Model # BU-00244-*

Material: *Banana Plug:* nickel-plated brass body; *Spring:* nickel-plated phosphor bronze; *Insulator:* ABS

Length: 1.15" (29mm)

***Std. Colors:** -0 Black, -2 Red

Rating: 15 Amps

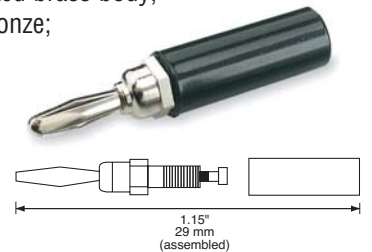

Set Screw Banana Plug

Model # BU-00245-*

Material: *Banana Plug:* nickel-plated brass body; *Spring:* nickel-plated phosphor bronze; *Insulator:* ABS

Length: 1.08" (27mm)

***Std. Colors:** -0 Black, -2 Red

Rating: 15 Amps

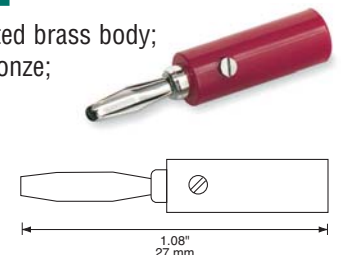

Banana Plugs and Jacks

Tapered Handle Banana Plug

Model # BU-00246-*

Material: *Banana Plug:* nickel-plated brass body; *Spring:* nickel-plated phosphor bronze; *Insulator:* ABS

Length: 1.02" (26mm)

*Std. Colors: -0 Black, -2 Red

Rating: 15 Amps

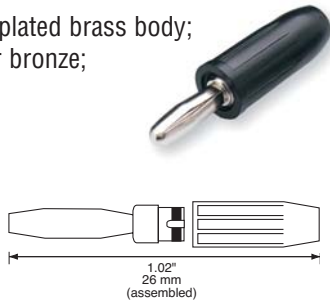

Stackable Banana Plug

Model # BU-00249-*

Material: *Banana Plug:* nickel-plated brass body; *Spring:* nickel-plated phosphor bronze; *Insulator:* ABS

Length: 1.68" (43mm)

*Std. Colors: -0 Black, -2 Red

Rating: 15 Amps

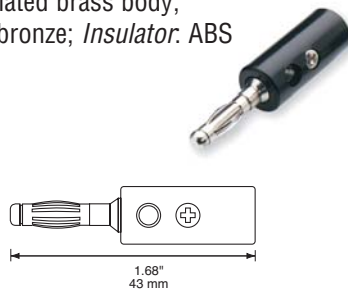

Unshrouded Stackable Banana Plug

Model # BU-16-*

Material: *Banana Plug:* nickel-plated brass body; *Spring:* nickel-plated beryllium copper; *Insulator:* Nylon

Length: 1.88" (47.7mm)

*Std. Colors: -0 Black, -2 Red

Rating: 1000 Volts, 15 Amps
(Hands free)



Insulated Stackable Banana Plug

Model # BU-31101-*

Material: *Banana Plug:* nickel-plated brass body; *Spring:* nickel-plated beryllium copper; *Insulator:* nylon

Length: 2.45" (62.23mm)

*Std. Colors: -0 Black, -2 Red

Rating: 20 Amps



Cable Mountable 4mm Shrouded Banana Plug

Model # BU-32603-*

Material: *Banana Plug:* nickel-plated brass; *Insulator:* nylon

Length: 1.91" (48.5mm)

*Std. Colors: -0 Black, -2 Red

Rating: 1000V, category III, 1500V,
category II, 20 Amps,
IEC 1010 Compliant



Insulated Banana Jack To Standard Banana Plug

Model # BU-32101-*

Material: *Banana Plug:* nickel-plated brass body; *Spring:* nickel-plated beryllium copper; *Insulator:* nylon

Length: 2.61" (66.3mm)

*Std. Colors: -0 Black, -2 Red,
-4 Yellow, -6 Blue

Rating: 1000 V, 15 Amps (hands
free), IEC 1010 Compliant



Insulated Banana Coupler

Model # BU-32601-*

Material: *Banana Plug:* nickel-plated
brass; *Insulator:* nylon

Length: 2.50" (63.5mm)

*Std. Colors: -0 Black, -2 Red,
-4 Yellow, -6 Blue

Rating: 1000V, 15 Amps, IEC 1010 Compliant



Dual Banana Plug

Model # BU-00247-*

Material: *Banana Plug:* nickel-plated brass body; *Spring:* nickel-plated phosphor bronze; *Insulator:* PVC

Length: 1.62" (41mm)

*Std. Colors: -0 Black, -2 Red,
-4 Yellow, -5 Green, -6 Blue

Rating: 15 Amps

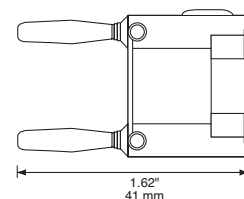

Insulated Banana Jack

Model # BU-00233-*

Material: *Banana Jack:* nickel-plated brass body; *Insulator:* nylon

Length: 0.66" (17mm)

***Std. Colors:** -0 Black, -2 Red

Rating: 15 Amp

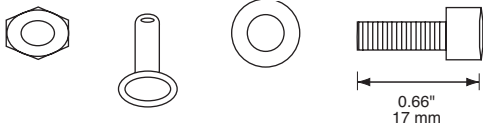

Insulated Phone Tip Jack

Model # BU-00234-*

Material: *Banana Jack:* nickel-plated brass body; *Spring:* nickel-plated phosphor bronze; *Insulator:* ABS

Length: 1" (25mm)

***Std. Colors:** -0 Black, -2 Red

Rating: 15 Amp

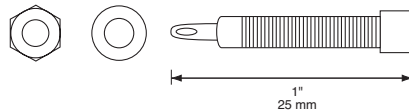

Pressfit Insulated Banana Jack with Solder Pin Connection

Model # BU-31602-*

Material: *Banana Plug:* nickel-plated brass; *Insulator:* Dupont 101L

Length: 1.25" (31.75mm)

***Std. Colors:** -0 Black, -2 Red, -4 Yellow, -6 Blue

Rating: 1000 V, 15 Amps, IEC 1010 Compliant



Pressfit Insulated Banana Jack with Spade Connection

Model # BU-31603-*

Material: *Banana Plug:* nickel-plated brass; *Insulator:* Dupont 101L

Length: 1.37" (34.8mm)

***Std. Colors:** -0 Black, -2 Red, -4 Yellow, -6 Blue

Rating: 1000 V, 15 Amps, IEC 1010 Compliant



Slim-Line Five Way Binding Post-Threaded

Model # BU-00281-*

Material: *Post:* nickel-plated brass; *Insulator:* nylon

Length: 2" (51mm)

***Std. Colors:** -0 Black, -2 Red

Rating: 15 Amps

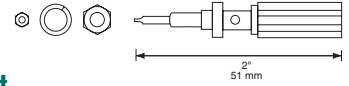

Five-Way Binding Post

Model # BU-00282-*

Material: *Post:* nickel-plated brass; *Insulator:* nylon

Length: 2.10" (53mm)

***Std. Colors:** -0 Black, -2 Red

Rating: 15 Amps



Dual Five-Way Binding Post

Model # BU-00283

Material: *Post:* nickel-plated brass; *Insulator:* nylon

Length: 1.80" (46mm)

Rating: 15 Amps

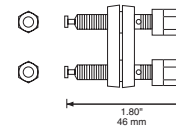

Screw-in Safety Socket with Stud and Metal Nut

Model # BU-31607-*

Material: *Hardware:* nickel-plated brass; *Insulator:* ABS-nylon composite

Length: 1.53" (39mm)

***Std. Colors:** -0 Black, -2 Red

Rating: 600V, category III, 1000V, category II, 35 Amps, IEC 1010 Compliant



Screw-in Safety Socket with Spade and Metal Nut

Model # BU-31609-*

Material: *Hardware:* nickel-plated brass; *Insulator:* ABS-nylon composite

Length: 1.26" (32mm)

***Std. Colors:** -0 Black, -2 Red

Rating: 600V, category III, 1000V, category II, 35 Amps, IEC 1010 Compliant



Grabbers, Probes and Spade Terminals

Mueller grabber clips and test probes are available in a wide variety of sizes to ensure that even the most hard to reach test point is easily accessible. We provide a fast and easy connection to terminals and component test leads.



Color Key

0=Black	4=Yellow	6=Blue
2=Red	5=Green	9=White

Plunger Clip

Model # BU-00201-*/BU-00202-*/BU-00203-*

Material: Cap & Body: glass filled nylon; Spring: stainless steel; Contact: beryllium copper; insulated to a single contact point

Length: 1.75" (44mm) (BU-00201-*); 2.50" (63mm) (BU-00202-*); 3.50" (88mm) (BU-00203-*)

*Std Colors: -0 black, -2 red

Rating: 1000 Volts, 10 Amps



Mini-Micro Plunger Clip

Model # BU-00208-*

Material: Cap & Body: tough, durable nylon; Spring: stainless steel compression coil; Contact: gold-plated beryllium copper

Length: 1.75" (44mm)

*Std Colors: -0 Black, -2 Red

Rating: 600 Volts, 3 Amps



Safety Plunger Clip Adapter

Model # BU-00207-*

Material: Cap & Body: nylon; Spring: stainless steel; Contact: beryllium copper

Length: 2.23" (56.64mm)

*Std Colors: -0 Black, -2 Red

Rating: 1000 Volts, 15 Amps



Right Angle Insulated Plunger Hook Clip

Model # BU-20431-*

Compatible with all shrouded, unshrouded, or retractable 0.16" (4mm) banana plugs

Material: Housing: nylon. Contact: nickel-plated beryllium copper

Length: 4.60" (116.84mm); the hook extends 0.41" (10mm) when fully depressed

*Std Colors: -0 Black, -2 Red, -4 Yellow, -6 Blue

Rating: 1000V, 15 Amps, IEC 1010 Compliant



Right Angle Insulated Plunger Clamp Clip

Model # BU-20432-*/BU-20433-*

Compatible with all shrouded, unshrouded, or retractable 0.16" (4mm) banana plugs

Material: *Housing:* nylon;
Contact: nickel-plated beryllium copper

Length: 5.50" (139.7mm) (BU-20432-*);
7.50" (190.5mm) (BU-20433-*)

***Std Colors:** -0 Black, -2 Red, -4 Yellow, -6 Blue

Rating: 1000V, 1 Amps, IEC 1010 Compliant



Right Angle Insulated Plunger Jaw Clip

Model # BU-20434-*

Compatible with all shrouded, unshrouded, or retractable 0.16" (4mm) banana plugs

Material: *Housing:* nylon;
Contact: nickel-plated steel

Length: 5.26" (133.6mm); the steel jaws extend 0.48" (12mm) and open to 1" (25mm)

***Std Colors:** -0 Black, -2 Red, -4 Yellow, -6 Blue

Rating: 1000V, 15 Amps, IEC 1010 Compliant



Insulated Plug-On Test Prod With Stainless Steel Tip

Model # BU-26101-*

Compatible with all shrouded, unshrouded, or retractable 0.16" (4mm) banana plugs

Material: *Housing:* nylon;
Contact: nickel-plated brass

Length: 3" (76.2mm)

***Std Colors:** -0 Black, -2 Red, -4 Yellow, -6 Blue

Rating: 1000V, 20 Amps, IEC 1010 Compliant



Insulated Plug-On Test Prod With 8-32 Thread

Model # BU-26106-*

Compatible with all shrouded, unshrouded, or retractable 0.16" (4mm) banana plugs

Material: *Housing:* nylon;
Contact: nickel-plated brass

Length: 3.3" (83mm)

***Std Colors:** -0 Black, -2 Red, -4 Yellow, -6 Blue

Rating: 1000V, 20 Amps, IEC 1010 Compliant



Ultra Tech Test Prod

Model # BU-26130-*

Compatible with all shrouded, unshrouded, or retractable 0.16" (4mm) banana plugs

Material: *Housing:* nylon;
Contact: nickel-plated brass

Length: 6.27" (159.3mm)

***Std Colors:** -0 Black, -2 Red, -4 Yellow, -6 Blue

Rating: 1000V, IEC 1010 Compliant



Safety Spade Terminal

Model # BU-30214-*

Compatible with all shrouded, unshrouded, or retractable 0.16" (4mm) banana plugs

Material: *Housing:* ABS-nylon;
Contact: nickel-plated brass

Length: 2.55" (64.8mm)

***Std Colors:** -0 Black, -2 Red, -4 Yellow, -5 Green, -6 Blue

Rating: 1000V, category III, 1500V, category II, 30 Amps, IEC 1010 Compliant





Test Leads and Patch Cords

Mueller manufactures a full line of test and interconnection leads for almost any application. For nearly a century, technicians and engineers have looked to Mueller as “perfection...for the best connection.”

Wire Table

Designation	AWG	Description	O.D.	Insulation	Temp	Rating
M	18	413/44 copper	.140" (3.56mm)	Silicone	150°C/-80°C	3000V, 22A
N	18	65/36 tinned copper	.140" (3.56mm)	PVC	80°C/-50°C	5000V, 6.5A
A	20	41/36 tinned copper	.088" (2.24mm)	PVC	105°C/-25°C	300V, 6.5A
E	22	19/34 tinned copper	.062" (1.56mm)	PVC	105°C/-55°C	1000V, 600V UL1483, 300V UL1509, 3.5A
D	18	65/36 tinned copper	.140" (3.56mm)	PVC	90°C	3000V, 6.5A

Order Key

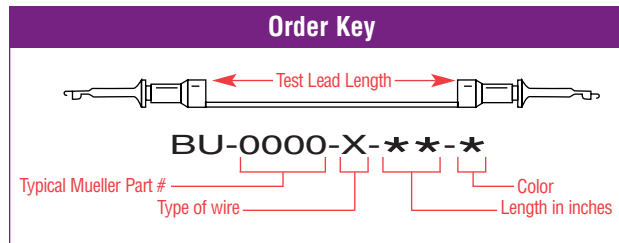

Coaxial Cables

Rating
B RG-58C/U
C RG-58C/U connected to 20AWG with Y-block
F RG-174C/U
L Twisted Pair Cable

Micro-Plunger Clip on Both Ends

Model # BU-1010-A-**-*

Mini-Plunger Clip on Both Ends

Model # BU-1111-A-**-*

Material: Hook-up Wire: #20 (41/36) AWG tinned copper with 105°C PVC insulation; Plunger: nylon housing, stainless steel spring, beryllium copper contact

****Length:** -12" (.3m), 24" (.6m), 36" (.9m), 48" (1.2m), 60" (1.5m)

***Std. Colors:** -0 Black, -2 Red

Rating: Hands free testing at 300V Category II, 5 Amps



Mini-Plunger to Stackable Banana Plug

Model # BU-1120-A-**-*

Material: Banana Plug: ABS housing, brass body and beryllium copper, nickel-plated, nine-leaf cage spring; Hook-up Wire: #20 (41/36) AWG tinned copper with 105°C PVC insulation; Plunger: nylon housing, stainless steel spring and beryllium copper contact

****Length:** -12" (.3m), 24" (.6m), 36" (.9m), 48" (1.2m), 60" (1.5m)

***Std. Colors:** -0 Black, -2 Red

Rating: Hands free testing at 300V, 5 Amps



Mini-Plunger to BNC Male with RG58

Model # BU-1150-C-**-0

Material: BNC Connector: MIL-C-30912, gold-plated center contact and silver-plated body; Coaxial Cable: shielded RG58C/U, MIL-C-17F, 50 ohm; Plunger: nylon housing, stainless steel spring and beryllium copper contact

****Length:** -12" (.3m), 24" (.6m), 36" (.9m), 48" (1.2m), 60" (1.5m)

Rating: Hands free testing at 300 VRMS



Mini-Micro-Plunger to Stackable Banana Plug

Model # BU-1420-A-**-*

Material: Banana Plug: ABS housing, brass body and beryllium copper, nickel-plated, nine-leaf cage spring; Hook-up Wire: #20 (41/36) AWG tinned copper with 105°C PVC insulation; Plunger: nylon housing, stainless steel spring and gold-plated, beryllium copper contact

****Length:** -12" (.3m), 24" (.6m), 36" (.9m), 48" (1.2m), 60" (1.5m)

***Std. Colors:** -0 Black, -2 Red

Rating: Hands free testing at 300V, 5 Amps



Stackable Single Banana Plugs on Both Ends

Model # BU-2020-A-**-*

Material: *Banana Plug:* ABS housing, brass body and beryllium copper, nickel-plated, nine-leaf cage spring; *Hook-up Wire:* #20 (41/36) AWG tinned copper with 105°C PVC insulation

****Length:** -12" (.3m), 24" (.6m), 36" (.9m), 48" (1.2m), 60" (1.5m)

***Std. Colors:** -0 Black, -2 Red

Rating: hands free testing at 300V, 10 Amps



Insulated Alligator Clip to Stackable Banana Plug

Model # BU-2030-A-**-*

Material: *Banana Plug:* ABS housing, brass body and beryllium copper, nickel-plated, nine-leaf cage spring; *Alligator Clip:* nickel-plated steel with PVC insulator; *Hook-up Wire:* #20 (41/36) AWG tinned copper with 105°C PVC insulation

****Length:** -12" (.3m), 24" (.6m), 36" (.9m), 48" (1.2m), 60" (1.5m)

***Std. Colors:** -0 Black, -2 Red

Rating: hands free testing at 300V, 10 Amps



Insulated Mini-Alligator Clip to Stackable Banana Plug

Model # BU-2031-A-**-*

Material: *Banana Plug:* ABS housing, brass body and beryllium copper, nickel-plated, nine-leaf cage spring; *Alligator Clip:* nickel-plated steel with PVC insulator; *Hook-up Wire:* #20 (41/36) AWG tinned copper with 105°C PVC insulation

****Length:** -12" (.3m), 24" (.6m), 36" (.9m), 48" (1.2m), 60" (1.5m)

***Std. Colors:** -0 Black, -2 Red

Rating: Hands free testing at 300V, 10 Amp



Multiple Feature Test Prod to Right Angle Shrouded Banana Plug

Model # BU-2241-D-48-*

Material: *Needle:* stainless steel; *Banana plugs:* nickel-plated brass; *Housing:* ABS; *Hook-up wire:* #18 AWG (65/36) tinned copper with 90°C PVC insulation

***Std. Colors:** -0 Black, -2 Red

Rating: 1000V Category II, 20 Amps



Shrouded Right Angle Banana Plug

Model # BU-2243-D-48-*

The stainless steel probe is Teflon® insulated except for the working end to prevent unwanted contact with other components that may be in the way

Material: *Needle:* stainless steel; *Banana Plugs:* nickel-plated brass; *Housing:* ABS; *Hook-up wire:* #18 AWG (65/36) tinned copper with 90°C PVC insulation

***Std. Colors:** -0 Black, -2 Red

Rating: 600V Category II, 20 Amps



Multiple Feature Test Prod to Unshrouded Banana Plug

Model # BU-2641-D-48-*

Material: *Needle:* stainless steel; *Banana Plugs:* nickel-plated brass; *Housing:* ABS; *Hook-up wire:* #18 AWG (65/36) tinned copper with 90°C PVC insulation

***Std. Colors:** -0 Black, -2 Red

Rating: 600V, 10 Amps



Multiple Feature Test Prod to Unshrouded Right Angle Banana Plug

Model # BU-2741-D-48-*

Material: *Needle:* stainless steel; *Banana plugs:* nickel-plated brass; *Housing:* ABS; *Hook-up wire:* #18 AWG (65/36) tinned copper with 90°C PVC insulation

***Std. Colors:** -0 Black, -2 Red

Rating: 600V, 10 Amps



Unshrouded Banana Plugs on Both Ends – Ultra-Flex-Silicone

Model # BU-2929-M-**-*

Material: *Unshrouded Banana Plugs:* Mueller No. Bu-16-*; *Hook-up wire:* #18 AWG (65/36) tinned copper with 90°C PVC insulation

****Length:** -10" (.25m), 20" (.5m), 39" (1m)

***Std. Colors:** -0 Black, -2 Red

Rating: Hands free testing at 3 kV, 20 Amps



Shrouded Banana Plug to Safety Test Prod - Silicone

Model # BU-4061-M-39-*

Material: *Banana Plugs:* nickel-plated brass body, nickel-plated beryllium copper spring; *Probe:* stainless steel tip with 8-32 UNC thread; *Hook-up Wire:* #18 AWG, silicone insulator

*Std. Colors: -0 Black, -2 Red, -4 Yellow, -6 Blue

Rating: 1000V, 20 Amps, IEC 1010 compliant



Shrouded Right Angle Banana Plug to Safety Test Prod - Silicone

Model # BU-4062-M-39-*

Material: *Banana Plugs:* nickel-plated brass body, nickel-plated beryllium copper spring; *Probe:* stainless steel tip with 8-32 UNC thread; *Hook-up Wire:* #18 AWG, silicone insulator

*Std. Colors: -0 Black, -2 Red, -4 Yellow, -6 Blue

Rating: 1000V, 20 Amps, IEC 1010 compliant



Stackable 0.080" (2.0mm) Pin Plug on Both Ends

Model # BU-4444-A-**-*

Tip jack accepts 0.080" (2.0mm) diameter pin jack contact

Material: *Pin Plug:* 0.080" (2.0mm) diameter; 0.500" (12.7mm) long, nickel-plated brass pin tip, nickel-plated beryllium copper spring, ABS housing; *Hook-up Wire:* #22 (19/34) AWG tinned copper with 105°C PVC insulation

**Length: -12" (.3m), 24" (.6m), 36" (.9m)

*Std. Colors: -0 Black, -2 Red

Rating: Hands free testing at 300VAC, 15 Amps



Shrouded Banana Plug on Both Ends – Silicone

Model # BU-6161-M-39-*

Material: *Banana Plugs:* nickel-plated brass body, nickel-plated beryllium copper spring; *Hook-up Wire:* #18 AWG, silicone insulator

*Std. Colors: -0 Black, -2 Red, -4 Yellow, -6 Blue

Rating: 1000V, 20 Amps, IEC 1010 compliant



Right Angle Shrouded Banana Plug to Shrouded Banana Plug - Silicone

Model # BU-6162-M-39-*

Material: *Banana Plugs:* nickel-plated brass body, nickel-plated beryllium copper spring; *Hook-up Wire:* #18 AWG, silicone insulator

*Std. Colors: -0 Black, -2 Red, -4 Yellow, -6 Blue

Rating: 1000V, 20 Amp, IEC 1010 compliant



Stackable Dual Banana Plug to Mini-Micro-Plunger with RG58

Model # BU-7014-B-**-*

Material: *Plunger:* nylon housing, stainless steel spring and beryllium copper contact; *Double Banana Plug:* ABS housing, brass body and beryllium copper, nickel-plated, nine-leaf cage spring; *Coaxial Cable:* shielded RG58C/U, MIL-C-17F, 50 ohm

**Length: -12" (.36m), 24" (.6m), 36" (.9m)

*Std. Colors: -0 Black, -2 Red

Rating: hands free testing at 300 VRMS



Stackable Dual Banana Plug to Stackable Single Banana Plug with RG58

Model # BU-7020-B-**-*

Material: *Single Banana Plug:* ABS housing, brass body and beryllium copper, nickel-plated, nine-leaf cage spring; *Double Banana Plug:* ABS housing, brass body and beryllium copper, nickel-plated, nine-leaf cage spring; *Coaxial Cable:* shielded RG58C/U, MIL-C-17F, 50 ohm

**Length: -12" (.36m), 24" (.6m), 36" (.9m)

*Std. Colors: -0 Black, -2 Red

Rating: Hands free testing at 500 VRMS



Stackable Dual Banana Plug to Mini-Alligator Clip with RG58

Model # BU-7031-B--***

Material: *Alligator clip:* nickel-plated steel with PVC insulator; *Double Banana Plug:* ABS housing, brass body and beryllium copper, nickel-plated, nine-leaf cage spring; *Coaxial Cable:* shielded RG58C/U, MIL-C-17F, 50 ohm

****Length:** -12" (.36m), 24" (.6m), 36" (.9m)

***Std. Colors:** -0 Black, -2 Red

Rating: Hands free testing at 300 VRMS



Stackable Dual Banana Plug to Stackable Pin Plug with RG58

Model # BU-7044-B--***

Material: *Pin Plug:* 0.080" (2.0mm) diameter; 0.500" (12.7mm) long, nickel-plated brass pin tip, nickel-plated beryllium copper spring, ABS housing; *Double Banana Plug:* ABS housing, brass body and beryllium copper, nickel-plated, nine-leaf cage spring; *Coaxial Cable:* shielded RG58C/U, MIL-C-17F, 50 ohm

****Length:** -12" (.36m), 24" (.6m), 36" (.9m)

***Std. Colors:** -0 Black, -2 Red

Rating: Hands free testing at 500 VRMS



Stackable Dual Banana Plug on Both Ends with RG58

Model # BU-7070-B--***

Material: *Double Banana Plug:* ABS housing, brass body and beryllium copper, nickel-plated, nine-leaf cage spring; *Coaxial Cable:* shielded RG58C/U, MIL-C-17F, 50 ohm

****Length:** -12" (.3m), 24" (.6m), 36" (.9m), 48" (1.2m), 60" (1.5m)

***Std. Colors:** -0 Black, -2 Red

Rating: Hands free testing at 300 VRMS



Shrouded Dual Banana Plug on Both Ends with RG58

Model # BU-7171-B--0**

Material: *Double Banana Plug:* ABS housing, brass body and beryllium copper, nickel-plated, nine-leaf cage spring; *Coaxial Cable:* shielded #22 AWG (7/30) twisted pair with drain connected to (-) side of one banana plug; side with drain connection is marked; shielded RG58C/U, MIL-C-17F, 50 ohm

****Length:** -12" (.3m), 24" (.6m), 36" (.9m), 48" (1.2m), 60" (1.5m)

Rating: Hands free testing at 500 VRMS



0.025" (.6mm) Square Pin Receptacle on Both Ends

Model # BU-8080-E--***

Material: *Pin Receptacle:* ABS housing, 0.025" (0.6mm) copper-nickel-tin alloy 725 with 0.000030" (0.00076mm) gold contact plating conductor; *Hook-up Wire:* #22 AWG (19/34) tinned copper with 105°C PVC insulation

****Length:** -6" (.15m), 12" (.3m), 24" (.6m), 36" (.9m)

***Std. Colors:** -0 Black, -2 Red

Rating: Hands free testing at 300V, 3 Amp



Insulated Alligator Clips on Both Ends

Model # BU-3030-A--***

Material: *Alligator Clip:* nickel-plated steel with PVC insulator; *Hook-up Wire:* #20 (41/36) AWG tinned copper with 105°C PVC insulation

****Length:** -12" (.3m), 24" (.6m), 36" (.9m), 48" (1.2m), 60" (1.5m)

***Std. Colors:** -0 Black, -2 Red

Rating: Hands free testing at 300V, 10 Amps



Insulated Alligator Clips on Both Ends - Coiled Cord

Model # BU-3030-C-24-*

Material: *Clip:* nickel-plated steel alligator with insulator (BU-60 and BU-62-*); *Coiled Cord:* single conductor 18AWG wire with 4mm O.D.

Length: -24" (.6m) retracted, 120" (3.) extended

***Std. Colors:** -0 Black, -2 Red

Rating: Hands free testing at 300V, 15 Amps



Insulated Alligator Clip to Stackable Dual Banana Plug with RG58

Model # BU-3070-C-**-0

Material: *Alligator Clip:* nickel-plated steel with PVC insulator; *Double Banana Plug:* ABS housing, brass body and beryllium copper, nickel-plated, nine-leaf cage spring; *Coaxial Cable:* Shielded RG58C/U, MIL-C-17F, 50 ohm

****Length:** -12" (.3m), 24" (.6m), 36" (.9m), 48" (1.2m), 60" (1.5m)

Rating: Hands free testing at 300 VRMS



Insulated Mini-Alligator Clip on Both Ends

Model # BU-3131-A-**-*

Material: *Alligator Clip:* nickel-plated steel with PVC insulator; *Hook-up Wire:* #20 (41/36) AWG tinned copper with 105°C PVC insulation

****Length:** -12" (.3m), 24" (.6m), 36" (.9m), 48" (1.2m), 60" (1.5m)

***Std. Colors:** -0 Black, -2 Red

Rating: Hands free testing at 300 VAC, 5 Amps



Insulated Mini-Alligator Lead Set

Model # BU-00285

Material: *Clip:* nickel-plated steel with PVC insulators; *Hook-up Wire:* #22 (19/34) AWG copper with 105°C PVC insulation

Length: 18" (.46m)

Colors: Includes 2 each: Black, Red, Yellow, Green, White

Rating: Hands free testing at 300V, 5 Amp



Insulated Alligator Lead Set

Model # BU-00286

Material: *Clip:* nickel-plated steel with PVC insulators; *Hook-up Wire:* #22 (19/34) AWG copper with 105°C PVC insulation

Length: 12" (.3m)

Colors: Includes 1 each: Black, Red, Yellow, Green, White

Rating: Hands free testing at 300V, 7 Amp



Insulated Alligator Lead Set

Model # BU-00287

Material: *Clip:* nickel-plated steel with PVC insulators; *Hook-up Wire:* #22 (19/34) AWG copper with 105°C PVC insulation

Length: 12" (.3m)

Colors: Includes 2 each: Black, Red, Yellow, Green, White

Rating: Hands free testing at 300V, 7 Amp



Shrouded Banana Plug to Piercing Clip - Silicone

Model # JP-7505-83-**-*

Piercing clips are J.S. Popper brand

Material: *Piercing Clip:* JP-8783; *Banana Plugs:* nickel-plated brass body, nickel-plated beryllium copper spring; *Hook-up Wire:* #18 AWG, silicone insulator

****Length:** -12" (.3m), 24" (.6m), 36" (.9m), 48" (1.2m)

***Std. Colors:** -0 Black, -2 Red, -4 Yellow, -6 Blue

Rating: 300V, 3 Amp



Ultra-Flex Test Lead Wires

Model # WI-M-18-*

Material: *Wire:* #18 AWG, silicone

***Std. Colors:** -0 Black, -2 Red, -4 Yellow, -5 Green, -6 Blue, -9 White

Rating: 3kV, 22 Amp



Mueller's coaxial cables and fully insulated BNC receptacles provide an additional margin of safety in connecting to instrumentation such as oscilloscopes, voltmeters, and network analyzers. Our BNC breakout test leads offer a wide variety of connector and clip combinations to meet your testing and connection needs.

Order Key		Coaxial Cables	
		Rating B RG-58C/U C RG-58C/U connected to 20AWG with Y-block F RG-174C/U L Twisted Pair Cable	
BU-0000-X-**-** Typical Mueller Part # Type of wire Color Length in inches			
Color Key		Available Test Lead Lengths	
0=Black 2=Red	4=Yellow 5=Green	6=Blue 9=White	6" 12" 24" 36" 48" 60"

BNC Male on Both Ends

Model # BU-5050-B--0**

Material: *BNC Male Connector:* gold-plated center contact, silver-plated body; (MIL-C-39012); *Coaxial Cable:* shielded RG58C/U, MIL-C17F, 50 ohm

****Length:** -12" (.3m), 24" (.6m), 36" (.9m), 48" (1.2m), 60" (1.5m)

Rating: Hands free testing at 500 VRMS on center conductor



BNC Male with Strain Relief on Both Ends

Model# BU-5454-B--0**

Material: *BNC Male Connector:* MIL-C-39012, silver-plated brass body, gold/nickel plated brass center contact; *Coaxial Cable:* RG58C/U, MIL-C17F, 50 ohm

****Length:** -12" (.3m), 24" (.6m), 36" (.9m), 48" (1.2m), 60" (1.5m)

Rating: Hands free testing at 500 VRMS on center conductor



BNC Male to Stackable Double Banana Plug

Model# BU-5070-B--0**

Material: *BNC Male Connector:* gold-plated center contact, silver-plated body; (MIL-C-39012); *Double Banana Plug:* ABS housing, brass body and beryllium copper, nickel-plated, nine-leaf cage spring; *Coaxial Cable:* shielded RG58C/U, MIL-C-17F, 50 ohm

****Length:** -12" (.3m), 24" (.6m), 36" (.9m), 48" (1.2m), 60" (1.5m)

Rating: Hands free testing at 500 VRMS on center conductor



BNC Female with Strain Relief on Both Ends

Model# BU-5555-B--0**

Material: *BNC Female Connector:* MIL-C-39012, silver-plated brass body, gold/nickel plated brass center contact; *Coaxial Cable:* RG58C/U, MIL-C17F, 50 ohm

****Length:** -12" (.3m), 24" (.6m), 36" (.9m), 48" (1.2m), 60" (1.5m)

Rating: Hands free testing at 500 VRMS on center conductor

Insulated BNC Male to BNC Female

Model# BU-5659-B-**-0

Material: *BNC Male/Female Connector:* fully insulated nylon housing; nickel-plated brass body, gold/nickel plated brass center contact; polyethylene dielectric; *Coaxial Cable:* RG58, 50 ohm

****Length:** -12" (.3m), 24" (.6m), 36" (.9m), 48" (1.2m), 60" (1.5m)

Rating: Hands free testing at 500 VRMS on center conductor



Insulated Alligator Clips to BNC Male With RG58

Model# BU-5030-C-**-0

Insulated Alligator Clips to BNC Male With RG174

Model# BU-5330-F-**-0

Material: *Alligator Clip:* nickel-plated steel with PVC insulator; *BNC Male Connector:* MIL-C-39012, gold-plated center contact and silver-plated body (RG174/U BNC is a commercial connector with nickel-plated body); *Coaxial Cable:* shielded RG58C/U, MIL-C-17F, 50 ohm or shielded RG174/U, MIL-C-17D, 50 ohm

****Length:** -12" (.3m), 24" (.6m), 36" (.9m), 48" (1.2m), 60" (1.5m)

Rating: Hands free testing at 300 VRMS on center conductor



BNC Male Breakout to Tinned End Wires

Model# BU-5100-A-4-0

Material: *BNC Male Connector:* quality tarnish-resistant, plated brass with a gold-plated brass center contact, ABS housing; *Hook-up Wire:* #20 AWG (41/36) tinned copper with 105°C PVC insulation

Rating: Hands free testing at 300 VRMS on center conductor



BNC Male Breakout to Mini-Micro-Grabbers

Model# BU-5114-A-4-0

Material: *BNC Male Connector:* quality tarnish-resistant, plated brass with a gold-plated brass center contact, ABS housing; *Mini-Micro-Grabbers* (No.208) conductor and abrasion resistant, nylon housing; *Hook-up Wire:* #20 AWG (41/36) tinned copper with 105°C PVC insulation

Rating: Hands free testing at 150 VRMS, 5 Amp

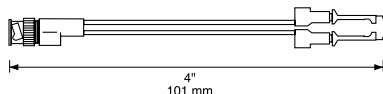

BNC Male Breakout to Stackable Single Banana Plugs

Model# BU-5120-A-4-0

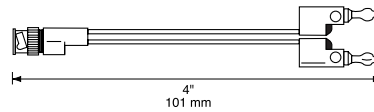

Material: *BNC Male Connector:* quality tarnish-resistant, plated brass with a gold-plated brass center contact, ABS housing; *Banana Plug:* premium nine-leaf, nickel-plated beryllium copper springs and copper alloy 360 bodies for minimum stacked in multiples, ABS housing; *Hook-up Wire:* #20 AWG (41/36) tinned copper with 105°C PVC insulation

Rating: Hands free testing at 300 VRMS, 5 Amp

BNC Male Breakout to Insulated Mini-Alligator Clips

Model# BU-5131-A-4-0

Material: *BNC Male Connector:* quality tarnish-resistant, plated brass with a gold-plated brass center contact, ABS housing; *Clip:* Mueller No. 30BL with No. 31 insulators; *Hook-up Wire:* #20 AWG (41/36) tinned copper with 105°C PVC insulation

Rating: Hands free testing at 300 VRMS, 10 Amp



BNC Male Breakout to Stackable 0.080" (2.0mm) Pin Plugs

Model# BU-5144-A-4-0

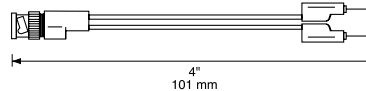

Material: *BNC Male Connector:* quality tarnish-resistant, plated brass with a gold-plated brass center contact, ABS housing; *Pin Tip:* nickel-plated brass 0.080" (2.0mm) dia; 0.500" (12.7mm) long; *Tip Jack:* Accepts 0.080" (2.0mm) dia. pin, nickel-plated, alloy 360 copper body; *Hook-up Wire:* #20 AWG (41/36) tinned copper with 105°C PVC insulation

Rating: Hands free testing at 300 VRMS, 5 Amps

BNC Female Breakout Style to Tinned End Wires

Model# BU-5200-A-4-0

Material: *BNC Female Connector:* quality tarnish-resistant, plated brass with a gold-plated brass center contact, ABS housing; *Hook-up Wire:* #20 AWG (41/36) tinned copper with 105°C PVC insulation

Rating: Hands free testing at 300 VRMS, 5 Amp



BNC Female Breakout to Insulated Mini-Alligator Clips

Model# BU-5231-A-4-0

Material: *BNC Female Connector:* quality tarnish-resistant, plated brass with a gold-plated brass center contact, ABS housing; *Clip:* Mueller No. 30BL with No. 31 insulators; *Hook-up Wire:* #20 AWG (41/36) tinned copper with 105°C PVC insulation

Rating: Hands free testing at 300 VRMS, 5 Amp



BNC Female Breakout to Mini-Micro-Grabbers

Model# BU-5214-A-4-0

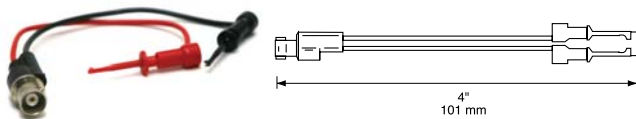

Material: *BNC Female Connector:* quality tarnish-resistant, plated brass with a gold-plated brass center contact, ABS housing; *Mini-Micro-Grabbers (No.208):* conductor and abrasion resistant, nylon housing; *Hook-up Wire:* #20 AWG (41/36) tinned copper with 105°C PVC insulation

Rating: Hands free testing at 300 VRMS, 5 Amp

BNC Female Breakout to Stackable 0.080" (2.0mm) Pin Plugs

Model# BU-5244-A-4-0

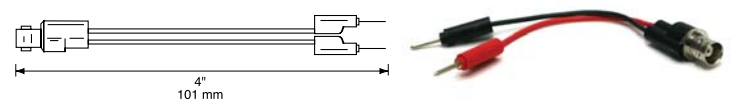

Material: *BNC Female Connector:* quality tarnish-resistant, plated brass with a gold-plated brass center contact, ABS housing; *Pin Tip:* nickel-plated brass 0.080" (2.0mm) dia; 0.500" (12.7mm) long; *Tip Jack:* accepts 0.080" (2.0mm) dia. pin, nickel-plated, alloy 360 copper body; *Hook-up Wire:* #20 AWG (41/36) tinned copper with 105°C PVC insulation

Rating: Hands free testing at 300 VRMS, 5 Amps

BNC Female Breakout to Stackable Single Banana Plugs

Model# BU-5220-A-4-0

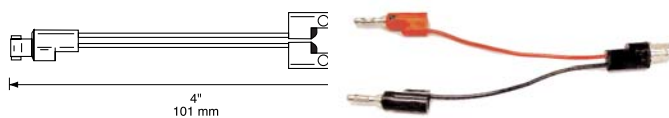

Material: *BNC Female Connector:* quality tarnish-resistant, plated brass with a gold-plated brass center contact, ABS housing; *Banana Plug:* premium nine-leaf, nickel-plated beryllium copper springs and copper alloy 360 bodies for minimum stacked in multiples, ABS housing; *Hook-up Wire:* #20 AWG (41/36) tinned copper with 105°C PVC insulation

Rating: Hands free testing at 300 VRMS, 10 Amps

Mini-Micro-Plunger to BNC Male

Model# BU-1450-C-**-0

Material: *BNC Male Connector:* MIL-C-39012, gold-plated center contact and silver-plated body; *Coaxial Cable:* shielded RG58C/U, MIL-C-17F, 50 ohm; *Plunger:* nylon housing, stainless steel spring and beryllium copper contact

****Length:** -12" (.3m), 24" (.6m), 36" (.9m), 48" (1.2m), 60" (1.5m)

Rating: Hands free testing at 300 VRMS on center conductor



Mueller DMM kits are designed for compatibility with Fluke, Agilent, Tektronix, and other DMM manufacturers. Reference page 28 for a Meter-Mate™ meter-to-accessory cross-reference table.



Order Key

BU-0000-X-00-*

Typical Mueller Part # — Type of wire — Color — Length in inches

Color Key			Available Test Lead Lengths		
0=Black	4=Yellow	6=Blue	6"	24"	48"
2=Red	5=Green	9=White	12"	36"	60"

400002 (34000 Series Bench DMM Meter Mate Kit)

34000 Series Bench DMM's Meter Mate Kit has compatible replacement leads for all Agilent 34000 Series digital multimeters.

QTY	P/N	DESCRIPTION
1	PM-50000	Blue tri-fold bag
1	Box 3	Retail Packaging Box
1	PM-1000	Compatibility Label
1	BU-6162-M-60-0	TL, banana-to-right angle banana, silicone, 60", 1kV, 20 Amp, black
1	BU-6162-M-60-2	TL, banana-to-right angle banana, silicone, 60", 1kV, 20 Amp, red
1	BU-26106-0	Test Probe, banana, 1kV, 20 Amp, black
1	BU-26106-2	Test Probe, banana, 1kV, 20 Amp, red
1	BU-65-0	Clip, insulated, banana, 1kV, 30 Amp, black
1	BU-65-2	Clip, insulated, banana, 1kV, 30 Amp, red
1	BU-20431-0	Insulated plunger hook, mini grip, 1kV, 3 Amp, black
1	BU-20431-2	Insulated plunger hook, mini grip, 1kV, 3 Amp, red
1	BU-00207-0	Threaded plunger, 1kV, 15 Amps, black
1	BU-00207-2	Threaded plunger, 1kV, 15 Amps, red
1	BU-26130-0	Ultra Tech Test Prod, 1kV, 15 Amp, black
1	BU-26130-2	Ultra Tech Test Prod, 1kV, 15 Amp, red
1	BU-30212-0	Insulated spade lug, black
1	BU-30212-2	Insulated spade lug, red
1	BU-32101-0	Banana Adapter, 1kV, 15 Amp, black
1	BU-32101-2	Banana Adapter, 1kV, 15 Amp, red



400003 (Fluke Replacement Electrical DMM Meter Mate Kit)

Electrical DMM Test Lead Kit offers a complete assortment of modular test leads and probes compatible with all Fluke DMMs.

QTY	P/N	Description
1	PM-1015	Poly Bag 6.5z11.5, Vinyl
1	Box 4	Retail Packaging Box
1	PM-1000	Compatibility Label
1	BU-6162-M-48-0	TL, banana-to-right angle banana, silicone, 48", black
1	BU-6162-M-48-2	TL, banana-to-right angle banana, silicone, 48", red
1	BU-26103-0	Test Probe, banana, 1000V, IEC Cat III, black
1	BU-26103-2	Test Probe, banana, 1000V, IEC Cat III, red
1	BU-656-2	Safety Clip, insulated, banana, red
1	BU-20434-0	Insulated plunger jaw clip, black
1	BU-20434-2	Insulated plunger jaw clip, red
1	BU-20431-0	Insulated plunger hook, mini grip, black
1	BU-20431-2	Insulated plunger hook, mini grip, red
1	BU-30212-0	Insulated spade lug, black
1	BU-30212-2	Insulated spade lug, red
1	BU-32101-0	Banana Adapter, 1kV, 15 Amp, black
1	BU-32101-2	Banana Adapter, 1kV, 15 Amp, red



400000 (Fluke Replacement Industrial/Automotive DMM Meter Mate Kit)

Automotive/Industrial DMM Test Lead Kit offers modular test probes and leads compatible with all Fluke DMMs.

QTY	P/N	Description
1	PM-50000	Blue tri-fold bag
1	Box 1	Retail Packaging Box
1	PM-1000	Compatibility Label
1	BU-6162-M-39-0	TL, banana-to-right angle banana, silicone, 39", 1kV, 20 Amp, black
1	BU-6162-M-39-2	TL, banana-to-right angle banana, silicone, 39", 1kV, 20 Amp, red
1	BU-26103-0	Test Probe, banana, 1kV, IEC Cat III, black
1	BU-26103-2	Test Probe, banana, 1kV, IEC Cat III, red
1	BU-65-0	Clip, insulated, banana, 1kV, 30 Amp black
1	BU-65-2	Clip, insulated, banana, 1kV, 30 Amp red
1	BU-20433-0	Insulated plunger, mini grip, 1kV, 1 Amp, black
1	BU-20433-2	Insulated plunger, mini grip, 1kV, 1 Amp, red
1	JP-491-0	Back probe, small, 20 Amp, black
1	JP-491-2	Back probe, small, 20 Amp, red
1	JP-591-0	Back probe, large, 20 Amp, black
1	JP-591-2	Back probe, large, 20 Amp, red
1	JP-8078-J-C0	Insulation piercing clip with black boot
1	JP-8078-J-C2	Insulation piercing clip with red boot



KT-MS002 (Deluxe Micro-scale Test Kit)
KT-MS001 (Deluxe Micro-scale Test Kit, accessories only)

Micro-scale Test Kit accessories are designed to attach to industry standard multimeter test probes or prods. These accessories allow convenient and safe testing on breadboards or printed circuit boards.

QTY	P/N	Description
2	BU-2241-D-48-*	TL, multi-feature test prod to right angle shrouded banana, 48", 1 red, 1 black
2	MS200-*	Breadboard Pin, 1 red, 1 black
2	MS201-*	Needle pin, 1 red, 1 black
2	MS202-*	Alligator Clip, 1 red, 1 black
2	MS203-*	Micro-plunger Clip, 1 red, 1 black
1	MS204	Battery Current Probe
2	MS205-*	Pin Socket, 1 red, 1 black
2	MS206-*	Magnetic Probe, 1 red, 1 black
2	MS208-*	Nano-plunger Clip, 1 red, 1 black
1	MS207	Carrying Pouch



KT-MS004 (Basic Micro-scale Test Kit)
KT-MS003 (Basic Micro-scale Test Kit, accessories only)

KT-MS003 includes all of the above accessories without the 48" test leads.

QTY	P/N	Description
2	BU-2241-D-48-*	TL, multi-feature test prod to right angle shrouded banana, 48", 1 red, 1 black
2	MS201-*	Needle Pin, 1 red, 1 black
2	MS202-*	Alligator Clip, 1 red, 1 black
2	MS203-*	Micro-plunger Clip, 1 red, 1 black
2	MS208-*	Nano-plunger Clip, 1 red, 1 black
2	MS200-*	Breadboard Pin, 1 red, 1 black
2	MS205-*	Pin Socket, 1 red, 1 black
1	MS207	Carrying pouch



Mueller Test Lead	Manufacturer & Meter Model	Mueller Test Lead	Manufacturer & Meter Model	Mueller Test Lead	Manufacturer & Meter Model
ALFA ELECTRONICS		BECKMAN		ECG	
400000 400002 400003 BU-2241-D-48-* BU-4062-M-39-* BU-6162-M-39-* KT-MS002	DMM-175A, DMM-2360, LCR-195, LCR-814, 7705	400000 400002 400003 BU-4061-M-39-* BU-6161-M-39-* KT-MS002	TECH-300, TECH-310, 310B, 310UL, 310T, 320, 320B, 330, 350, 360, 3000, 3010, 3010B, 3020, 3020UL, 3030, 3050, 4410, DM40, DM45, HD100, HD11, HD110T, HD130	400000 400002 400003 BU-2241-D-48-* BU-4062-M-39-* BU-6162-M-39-* KT-MS002	AM-20, FET-43, DM-74, DM-76, DM-300, DM-310, DM-410, DM-78, DM-305
A.W. SPERRY		BU-2241-D-48-* BU-4062-M-39-* BU-6162-M-39-*	HD151, HD152, HD153, 222, 223, RMS225	ELENCO	
400000 400002 400003 BU-2641-D-48-* KT-MS002	DP-300, DP-306, DP-310, DP-316, EZ-6100, EZ-6110, EZ- 6200, EZ-6220, SP-160, SP-170, SP-250, SP-1000F	BU-2741-D-48-*	DM15, DM20, DM25, DM77, TECH-300, TECH-310, 310UL, 320B, 330, 800, 850, DL243A, 3000, 3010, 3010B, 3010UL, 3020, 3020B, 3020U; 3030 (BEFORE 8/1/83)	400000 400002 400003 BU-2741-D-48-* KT-MS002	M-1400, CM-1500A, CM-1550, M-1600, M-1650, M-5000
BU-4061-M-39-* BU-6161-M-39-*	DM-3010	BU-2241-D-48-* BU-4062-M-39-* BU-6162-M-39-* KT-MS002	DMSLX, DM10XL, DM15XL	BU-4061-M-39-* BU-6161-M-39-*	M-3500, M-4500
AMERICAN RELIANCE INC.		Bel MERIT		BU-2241-D-48-* BU-4062-M-39-* BU-6162-M-39-* KT-MS002	LC-1800, M-2600, M-2650, M-2661, M-2671, M-2680, M-2690, M-7000
400000 400002 400003 BU-2741-D-48-* BU-4061-M-39-* BU-6161-M-39-* KT-MS002	AR-120, AR-140, AR-130A/B, AR- 160H, AR-170NL, AR-180T, AR230S, AR-260CP, AR- 280CA, AR-690LP, AR-270NL, AR-700T	400000 400002 400003 BU-2741-D-48-* KT-MS002	AM201	400000 400002 400003 BU-2241-D-48-* BU-4062-M-39-* BU-6162-M-39-* KT-MS002	ACM-3A, DCM-1A, DM-3650B, DMR- 26, FD-81T, FD-91T, FD-95AR, FD-100TC, FDA-50
BU-2241-D-48-* BU-4062-M-39-* BU-6162-M-39-*	AR-3200	BU-2241-D-48-* BU-4062-M-39-* BU-6162-M-39-*	AA300, DM20S, DM30S, DM3000, DM3050, DM3100, DM3200, DM4100, DM4700, DM5050C, DM5100	BU-2741-D-48-*	F-72, MT-2
AMPROBE		BIDDLE		EXTECH	
400000 400002 400003 BU-2741-D-48-* KT-MS002	AM-1A, AM-2A, AM-2B, AM2DP, BDP, AM-3B, AM-5, AM-6	400000 400002 400003 BU-2741-D-48-* KT-MS002	10, DA116B, DA117	400000 400002 400003 BU-2241-D-48-* BU-4062-M-39-* BU-6162-M-39-* KT-MS002	D380196, D380198, D380285, D380501, D380487, D380602
BU-4061-M-39-* BU-6161-M-39-*	AM-4B, AM-6A	BU-2241-D-48-* BU-4062-M-39-* BU-6162-M-39-*	CAIRAD	BU-2741-D-48-*	D38091, D380165, D380166, D380168, D380652
BU-2241-D-48-* BU-4062-M-39-* BU-6162-M-39-*	ACD-10, ACD-11, AM-1E, AM-2E, AM-2EDP, AM-3E, AM- 1200, AM-1250, AM-1260, AM- 1280, AM-4A, AM-2BB, AM- 2BBDP, AM-4	BU-2641-D-48-* KT-MS002	65-267	BU-2641-D-48-*	D380900, D380910, D380911, D380913
ARISTA		BU-2741-D-48-*	65-260, 65-261, 65-264, 65-265	BU-4061-M-39-* BU-6161-M-39-*	D380925, D380950 D380925, D380950
400000 400002 400003 BU-2641-D-48-* KT-MS002	70-459, 70-463, 70-480, 70-485, 70-490	DATA PRECISION		BU-2741-D-48-*	D380960
B & K PRECISION		400000 400002 400003 BU-2641-D-48-* KT-MS002	935, 936, 938, 945, 1350, 1351, 2480(R), 2590(R), 3400(A), 3500, 3600, 7500, 8100, 8200	BU-2241-D-48-* BU-4062-M-39-* BU-6162-M-39-*	D381909
400000 400002 400003 BU-2641-D-48-* KT-MS002	114, 214, 227, 283, 290, 530, 810A, 820, 830, 2801, 2805, 2830, 2831, 2831A	DATA TECH			
BU-4061-M-39-* BU-6161-M-39-*	340A, 350, 2608, 2807, 2816, 2817, 2818, 2820, 2832, 2833, 2834, 2845, LA1000	400000 400002 400003 BU-2641-D-48-* KT-MS002	20, 30A, 30LC, 30R, 31, 45		
BU-2741-D-48-*	111, 114, 116, 117, 214, 2703, 2704, 2800, 2810, 2815, 815, 875A, 878				
BU-2241-D-48-* BU-4062-M-39-* BU-6162-M-39-*	388-HD, 810A, 875A, 2911, 2912, 2940, 2945, 2960, 2860				

Test Lead to Meter Cross Reference

Mueller Test Lead Manufacturer & Meter Model

Mueller Test Lead	Manufacturer & Meter Model
400000 400002 400003 BU-4061-M-39-* BU-6161-M-39-* KT-MS002	FLUKE D800, D802, D804, 8020A, 8020B, 8021B, 8022A, 8022B, 8024A, 8024B, 8026B, 8050A
BU-2641-D-48-*	334, D810, D811, 8000A, 8010A, 8012A, 8030A, 8040A, 8125A, 8200A, 8291A, 8300A, 8375A, 8400A, 8500A, 8502A, 8520A, 8522A, 8600A, 8800A, 8810A
BU-2241-D-48-* BU-4062-M-39-* BU-6162-M-39-*	10, 11, 12, 21-II, 23-II, 25, 27, 29-II, 37, 45, 70-II, 73-II, 75-II, 76, 77-II, 79-II, 83, 85, 87, 863, 865, 8060A, 8062A
400000 400002 400003 BU-4061-M-39-* BU-6161-M-39-* KT-MS002	FOTEC M-100, M-110
400000 400002 400003 BU-2641-D-48-* KT-MS002	G. C. ELECTRONICS 20-200, 20-207, 20-210
400000 400002 400003 BU-2241-D-48-* BU-4062-M-39-* KT-MS002	GOLDSTAR DM-6335, DM-7143, DM-7333, DM-8135, DM-8243, DM-8433, DM-9183
BU-6162-M-39-*	DM-6335, DM-7143, DM-7333, DM-8135, DM-8243, DM-8433, DM-9183
BU-2241-D-48-0* BU-4062-M-39-* BU-6162-M-39-*	65-260, 65-261, 65-264, 65-265
BU-2031-A-00-*	DM-9055S
400000 400002 400003 BU-2641-D-48-* KT-MS002	HEWLETT PACKARD 3468A
BU-2241-D-48-* BU-4062-M-39-* BU-6162-M-39-*	HP-970, HP-971A, HP-972A, HP-973A, HP-974A, HPE2373A, HPE2377A, HPE2378A
400000 400002 400003 BU-2641-D-48-* KT-MS002	HICKOCK LX303, LX304, LX306
BU-4061-M-39-* BU-6161-M-39-*	MX331, MX333

Mueller Test Lead Manufacturer & Meter Model

Mueller Test Lead	Manufacturer & Meter Model
400000 400002 400003 BU-2741-D-48-* KT-MS002	HIOKI 3011, 3212
BU-2241-D-48-* BU-4062-M-39-* BU-6162-M-39-*	M-7000, LC-1800
400000 400002 400003 BU-2241-D-48-* BU-4062-M-39-* BU-6162-M-39-* KT-MS002	HITACHI VR-3510, VR-3525, VR-3550
400000 400002 400003 BU-2241-D-48-* BU-4062-M-39-* BU-6162-M-39-* KT-MS002	INSTEK DM-351, BM-352, DM-391, DM-392, DM-393
400000 400002 400003 BU-2641-D-48-* KT-MS002	ITT METRIX MX-522, MX-562, MX-563, MX-575
400000 400002 400003 BU-4061-M-39-* BU-6161-M-39-* KT-MS002	KEITHLEY 128, 130, 130A, 131, 132C, 132F, 135, 135A, 169, 176, 177, 179A, 181, 191, 192, 195
400000 400002 400003 BU-2241-D-48-* BU-4062-M-39-* BU-6162-M-39-* KT-MS002	KELVIN 92, 93, 94, 95, 100, 150, 200, PRO-400
400000 400002 400003 BU-2641-D-48-* KT-MS002	KINGDOM (KDE) ETC-2000, ETC-2050, ETC-5000T, ETU-200, ETU-202, ETU-500, ETU-2050, ETU-3000, ETU-5000, ETU-5001, KD-25C, KD-30C, KD-55C, KD-300, KD-305, KD-600, KD-605, KD-615
BU-2241-D-48-* BU-4062-M-39-* BU-6162-M-39-*	KD-508

Mueller Test Lead Manufacturer & Meter Model

Mueller Test Lead	Manufacturer & Meter Model
400000 400002 400003 BU-2241-D-48-* BU-4062-M-39-* BU-6162-M-39-* KT-MS002	MERCER 9301, 9340, 9370, 9401, 9670
400000 400002 400003 BU-2241-D-48-* BU-4062-M-39-* BU-6162-M-39-* KT-MS002	METEX M80, M3610, M3610B, M3620, M3630B, M3630CR, M3650, M3650B, 3650CR, M3800, M3900TD, M4600, M4630, M4630B, M4630CR, M4650, M4650B, M4650CR
BU-2641-D-48-*	M200, M300, M400, M500, GL-20
400000 400002 400003 BU-2241-D-48-* BU-4062-M-39-* BU-6162-M-39-* BU-4061-M-39-* BU-6161-M-39-* KT-MS002	MITCHELL DSA2003, 3104
BU-2741-D-48-*	DC801, FT303TR, FT602B, TCYF1075, TC4055, 1800A
BU-4061-M-39-* BU-6161-M-39-*	TCMIT166
BU-4061-M-39-* BU-6161-M-39-*	YF1030C, YF3000, 7905A
400000 400002 400003 BU-2641-D-48-* KT-MS002	MODUTEC ACT-25, ACT-30, ACT-50, ACT-100, BT-22, CT-300, CT-600, CT-1200, MO-20KT, MO-2K
400000 400002 400003 BU-2641-D-48-* KT-MS002	NON-LINEAR SYSTEMS TT-20
400000 400002 400003 BU-4061-M-39-* BU-6161-M-39-* KT-MS002	NORTH AMERICAN SOAR 3025, 3030, 3050, 5025, 5030
BU-2641-D-48-*	8010, 8025, 8050, 8090, TC-202, ME-530, ME-540, ME-550, SX-220

Mueller Test Lead	Manufacturer & Meter Model	Mueller Test Lead	Manufacturer & Meter Model	Mueller Test Lead	Manufacturer & Meter Model
	NORMA		SIMPSON		UNIVOLT
400000 400002 400003 BU-4061-M-39-* BU-6161-M-39-* KT-MS002	D-1150, D-1218, DA-1737, MD-11, MD-12, MD-13, MD-14, BU-4061-C-24-*	400000 400002 400003 BU-2741-D-48-* KT-MS002	202, 208, 209, 229-2, 250, 255, 260, 260-8Xi, 260-6XL, 261, 262-3, 263, 265, 267, 268, 269-2, 269-3, 270-(1,2,3,4), 360, 362-2, 370 to 377, 460, 464, 465, 605-2, TS111-3	400000 400002 400003 BU-2241-D-48-* BU-4062-M-39-* BU-6162-M-39-* KT-MS002	DT810, DT820, DT830
	OMEGA				VALHALLA SCIENTIFIC
400000 400002 400003 BU-2741-D-48-* KT-MS002	HHM55, HHM57	BU-4061-M-39-* BU-6161-M-39-* BU-6162-M-39-*	487, 488	400000 400002 400003 BU-2641-D-48-* KT-MS002	3301, 3302, 4400, 4500
	PHILMETRIC		SPECO		VIZ
400000 400002 400003 BU-2741-D-48-* KT-MS002	MD100	400000 400002 400003 BU-2641-D-48-* KT-MS002	FD-80, FD-90	400000 400002 400003 BU-2241-D-48-* BU-4062-M-39-* BU-6162-M-39-* KT-MS002	WD-747, WD-750A, WD-753, WD-758, WD-759, WD-760, WD-761, WD-762, WD-763, WV-516B, WV-517B, WV-518B, WV-519C, WV-520B, WV-526B, WV-531A, WV-547B, WV-547C, WV-547D, WV-590, WV-591
BU-2241-D-48-* BU-4062-M-39-* BU-6162-M-39-*	MD150		TRIPLETT		WAVETEK
		BU-4061-M-39-* BU-6161-M-39-* BU-2241-D-48-* BU-4062-M-39-* BU-6162-M-39-*	320-G/P, 330-G/P, 340-G/P, 350-G/P, 360-G/P, 603 TYPE 2, 615, 630APL TYPE 5, 630APLK TYPE 5, 630NA TYPE 4, 630NS TYPE 3, 630PL TYPE 5, 630PLK TYPE 7, 666R TYPE 2	400000 400002 400003 BU-2241-D-48-* BU-4062-M-39-* BU-6162-M-39-* KT-MS002	AC30A, HD100, HD110, HD110T, HD103B, HD140B, HD160, 2010, 2020, 2030, RMS225, 300A, 310B, 320B, 330B, 850, DM5XL, DM10XL, DM15XL, DM23XT, DM25XT, DM27XT, DM153, CDM600, 4410B, CM20A, LM22A
	PROTEK			BU-2641-D-48-*	WESTON
400000 400002 400003 BU-2241-D-48-* BU-4062-M-39-* BU-6162-M-39-* KT-MS002	A-403, 504, 505, 506, B-797, B-845, CM-108, D-902, D-906, D-910F, D-927, D-935A, D-937, D-945, D-981, D-982, D-4500E, DI-2000M, TM-1300K	BU-4061-M-39-* BU-6161-M-39-* BU-2241-D-48-* BU-4062-M-39-* BU-6162-M-39-*	2, 40, 42, C45, 50, 1101, 3500, 3550, 4404, 4700, 4750, 4800, 6800 SERIES, 6810 SERIES	400000 400002 400003 BU-2641-D-48-* KT-MS002	660, 661, 662, 663, 6000, 6100, 7060 A /C / G
BU-2241-D-48-* BU-4062-M-39-* BU-6162-M-39-*	A-400, A-423, A-445, A-450, A-480B, A-2500I, A-4205, D-640AB		3350, 3360, (3525, 3526 BLACK ONLY) 3525A		6402, 6404, 6502, 6504, 7130, 7135, 7141, 7145, 7310, 7320
	RACAL-DANA		TEKTRONIX		
400000 400002 400003 BU-2741-D-48-* KT-MS002	4001, 4002, 4002A, 4003, 4004, 4005, 5000, 5001, 5003, 5004, 5005, 5006, 5900, 5940, 6000, 6001, 6002, 6900	400000 400002 400003 BU-2641-D-48-* KT-MS002	DMM250, DMM353		
			UNIVERSAL ENTERPRISES INC.		
		400000 400002 400003 BU-2641-D-48-* KT-MS002	DM25, DM100, M75, M110		

Custom Manufacturing

In addition to the products found in our catalog, we manufacture a large variety of custom leads and interconnects for original equipment manufacturers. Our engineering staff continues to develop new answers for tomorrow's most complex requirements. We design to international standards, written specifications or your application specific requirements. Core capabilities include thermo-plastic injection molding, automatic assembly and stamping.





Packaged Parts

Mueller's packaged product feature attractive point-of-purchase cards with related cross-selling product references. Mueller has assembled the most popular selling product in a comprehensive package program utilizing (UPC) bar code standards. Our package cards are designed to reduce retail real estate requirements.

Packaged Part #	Bulk Part #	Packaged Part #	Bulk Part #	Packaged Part #	Bulk Part #	Packaged Part #	Bulk Part #
010000	(1) BU-21APN, (1) BU-21APS, (1) BU-23-0, (1) BU-23-2	080015	(1) BU-1414-E-36-2	080082	(1) BU-1111-A-48-2	100009	(1) BU-4162-M-48-0, (1) BU-4162-N-48-2
010001	(1) BU-24APS, (1) BU-24APN, (1) BU-26-0, (1) BU-26-2	080016	(1) BU-1420-A-36-0	080083	(1) BU-1111-A-60-2	100010	(1) BU-4162-N-48-0, (1) BU-4162-N-48-2
010002	(1) BU-75K	080017	(1) BU-1420-A-36-2	080084	(1) BU-1111-A-60-2	110000	(1) BU-2841-D-48-*, (2) BU-60TBO, (2) BU-62-*, (2) BU-00230-*, (2) BU-00225-*, (2) BU-00207-*
010003	(2) BU-27, (1) BU-29-0, (1) BU-29-2	080018	(1) BU-2020-A-36-0	080085	(1) BU-1120-A-12-0	110001	(2) BU-4641-D-48-*, (2) BU-62-*, (2) BU-60TBO, (2) BU-00230-*, (2) BU-00225-*, (2) BU-00207-*
010004	(4) BU-30, (2) BU-32-0, (2) BU-32-2	080019	(1) BU-2020-A-36-2	080086	(1) BU-1120-A-12-2	110002	(2) BU-6441-D-48-*, (2) BU-62-*, (2) BU-60TBO, (1) BU-1149-A-12-0, (2) BU-00225-*, (2) BU-00207-*
010005	(4) BU-30C, (2) BU-32-0, (2) BU-32-2	080020	(1) BU-2030-A-36-0	080087	(1) BU-1120-A-24-0	110003	(2) BU-2741-D-48-*, (2) BU-62-*, (2) BU-60TBO, (2) BU-00230-*, (2) BU-00225-*, (2) BU-00207-*
010006	(4) BU-34, (2) BU-36-0, (2) BU-36-2	080021	(1) BU-2030-A-36-2	080088	(1) BU-1120-A-24-2	110004	(2) BU-2241-D-48-*, (2) BU-62-*, (2) BU-60TBO, (2) BU-00230-*, (2) BU-00225-*, (2) BU-00207-*
010007	(4) BU-34C, (2) BU-36-0, (2) BU-36-2	080022	(1) BU-2031-A-36-0	080089	(1) BU-1120-A-48-0	110005	(2) BU-2641-D-48-*, (2) BU-62-*, (2) BU-60TBO, (2) BU-00230-*, (2) BU-00225-*, (2) BU-00207-*
010008	(4) BU-45, (2) BU-47-0, (2) BU-47-2	080023	(1) BU-2031-A-36-2	080090	(1) BU-1120-A-48-2	110006	(2) BU-2141-D-48-*, (2) BU-62-*, (2) BU-60TBO, (2) BU-00230-*, (2) BU-00225-*, (2) BU-00207-*
010009	(2) BU-48B, (1) BU-49-0, (1) BU-49-2	080024	(1) BU-2929-M-10-0	080091	(1) BU-1120-A-60-0	110007	(1) BU-2141-D-48-0, (1) BU-2143-D-48-0, (1) BU-2143-D-48-2
010010	(2) BU-50C, (1) BU-49-0, (1) BU-49-2	080025	(1) BU-2929-M-10-2	080092	(1) BU-1120-A-60-2	110008	(1) BU-2143-D-48-0, (1) BU-2143-D-48-2
010011	(2) BU-60CHS-0, (2) BU-60CHS-2	080026	(1) BU-2929-M-20-0	080093	(1) BU-1149-A-12-0	110009	(1) BU-2241-D-48-0, (1) BU-2241-D-48-2
010012	(4) BU-60CS, (2) BU-62-0, (2) BU-62-2	080027	(1) BU-2929-M-20-2	080094	(1) BU-1149-A-12-2	110010	(1) BU-2243-D-48-0, (1) BU-2243-D-48-2
010013	(2) BU-60HS-0, (2) BU-60HS-2	080028	(1) BU-2929-M-39-0	080095	(1) BU-1149-A-24-0	110011	(1) BU-2641-D-48-0, (1) BU-2641-D-48-2
010014	(4) BU-60S, (2) BU-62-0, (2) BU-62-2	080029	(1) BU-2929-M-39-2	080096	(1) BU-1149-A-24-2	110012	(1) BU-2643-D-48-0, (1) BU-2643-D-48-2
010015	(4) BU-85, (2) BU-87-0, (2) BU-87-2	080030	(1) BU-3030-A-36-0	080097	(1) BU-1149-A-48-0	110013	(1) BU-2741-D-48-0, (1) BU-2741-D-48-2
010016	(2) BU-63-0, (2) BU-63-2	080031	(1) BU-3030-A-36-2	080098	(1) BU-1149-A-48-2	110014	(1) BU-2743-D-48-0, (1) BU-2743-D-48-2
010017	(10) BU-30	080032	(1) BU-3070-C-36-0	080099	(1) BU-1149-A-60-0	110015	(1) BU-2841-D-48-0, (1) BU-2841-D-48-2
010018	(10) BU-30C	080033	(1) BU-3131-A-36-0	080100	(1) BU-1149-A-60-2	110016	(1) BU-4641-D-48-0, (1) BU-4641-D-48-2
010019	(10) BU-34	080034	(1) BU-3131-A-36-2	080101	(1) BU-1414-E-12-0	110017	(1) BU-6441-D-48-0, (1) BU-6441-D-48-2
010020	(10) BU-34C	080035	(1) BU-5030-C-36-0	080102	(1) BU-1414-E-12-2	110018	(2) BU-60TBO, (1) BU-4062-M-39-0, (1) BU-4062-M-39-2, (1) BU-62-0, (1) BU-62-2
010021	(6) BU-45	080036	(1) BU-5031-C-36-0	080103	(1) BU-1414-E-48-0	110019	(1) BU-26101-0, (1) BU-26101-2, (1) BU-6162-M-39-0, (1) BU-65-0, (1) BU-65-2
010022	(6) BU-48B	080037	(1) BU-5050-B-36-0	080104	(1) BU-1414-E-48-2	110020	(1) BU-26130-0, (1) BU-26130-2, (1) BU-6162-M-39-0, (1) BU-6162-M-39-2
010023	(6) BU-55	080038	(1) BU-5070-B-36-0	080105	(1) BU-1420-A-12-0	150000	(4) BU-00232
010024	(6) BU-60CS	080039	(1) BU-5656-B-36-0	080106	(1) BU-1420-A-12-2	150001	(2) BU-00233-0, (2) BU-00233-2
010025	(6) BU-60S	080040	(1) BU-7070-B-36-0	080107	(1) BU-1450-C-12-0	150002	(4) BU-00241
010026	(6) BU-70S	080041	(1) BU-8080-E-12-0	080108	(1) BU-2020-A-48-0	150003	(4) BU-00242
010027	(6) BU-85	080042	(1) BU-8080-E-12-2	080109	(1) BU-2020-A-48-2	150004	(2) BU-00243-0, (2) BU-00243-2
010028	(1) BU-21APN, (1) BU-21APS	080043	(1) BU-1449-E-36-0, (1) BU-1449-E-36-2	080110	(1) BU-2020-A-60-0	150005	(2) BU-00244-0, (2) BU-00244-2
010029	(1) BU-24APN, (1) BU-24APS	080044	(1) BU-1080-E-12-0	080111	(1) BU-2020-A-60-2	150006	(2) BU-00245-0, (2) BU-00245-2
010030	(4) BU-27	080045	(1) BU-1080-E-12-2	080112	(1) BU-3030-A-12-0	150007	(2) BU-00246-0, (2) BU-00246-2
010031	(1) BU-41A-0, (1) BU-41A-2	080046	(1) BU-1421-A-36-0	080113	(1) BU-3030-A-12-2	150008	(1) BU-00247-0
010032	(1) BU-46A-0, (1) BU-46A-2	080047	(1) BU-1421-A-36-2	080114	(1) BU-3030-A-48-0	150009	(1) BU-00260
010033	(1) BU-65-0, (1) BU-65-2	080048	(1) BU-1170-F-36-0	080115	(1) BU-3030-A-48-2	150010	(1) BU-00262-0
010034	(4) BU-30TBO	080049	(1) BU-1153-F-36-0	080116	(1) BU-7070-B-12-0	150011	(1) BU-00283
010035	(4) BU-60TBO	080050	(1) BU-1156-C-36-0	080117	(1) BU-7070-B-12-2		
010036	(4) BU-30TBO, (2) BU-31-0, (2) BU-31-2	080051	(1) BU-1450-C-36-0	080118	(1) BU-7070-B-24-2		
010037	(4) BU-60TBO, (2) BU-62-0, (2) BU-62-2	080052	(1) BU-1456-C-36-0	080119	(1) BU-00285		
010038	(2) BU-27, (2) BU-48B, (1) BU-29-0, (1) BU-29-2, (1) BU-49-0, (1) BU-49-2	080053	(1) BU-1480-E-12-0	080120	(1) BU-00286		
010039	(2) BU-27C, (2) BU-48C, (1) BU-29-0, (1) BU-29-2, (1) BU-49-0, (1) BU-49-2	080054	(1) BU-1480-E-12-2	080121	(1) BU-00287		
010040	(2) BU-30, (2) BU-70, (1) BU-32-0, (1) BU-32-2, (1) BU-72-0, (1) BU-72-2	080055	(1) BU-1481-E-12-0	090000	(1) M08SW		
010041	(2) BU-30C, (2) BU-70C, (1) BU-32-0, (1) BU-32-2, (1) BU-72-0, (1) BU-72-2	080056	(1) BU-1481-E-12-2	090001	(1) M10X1		
010042	(2) BU-60S, (2) BU-48B, (2) BU-27, (2) BU-24APN	080057	(1) BU-5330-F-36-0	090002	(1) M10X10		
010043	(2) BU-61, (1) BU-62-0, (1) BU-62-2	080058	(1) BU-3056-C-36-0	090003	(1) M10SW		
080000	(1) BU-1010-A-36-0	080059	(1) BU-5331-F-36-0	090004	(1) M10X100		
080001	(1) BU-1010-A-36-2	080060	(1) BU-3156-C-36-0	090005	(1) M12X100		
080002	(1) BU-1031-A-36-0	080061	(1) BU-3180-E-12-0	090006	(1) M14X10		
080003	(1) BU-1031-A-36-2	080062	(1) BU-3180-E-12-2	090007	(1) M12X1		
080004	(1) BU-1111-A-36-0	080063	(1) BU-4444-A-36-0	090008	(1) M12X10		
080005	(1) BU-1111-A-36-2	080064	(1) BU-4444-A-36-2	090009	(1) M12SW		
080006	(1) BU-1120-A-36-0	080065	(1) BU-3070-F-36-0	100000	(1) BU-6161-M-39-0, (1) BU-6161-M-39-2		
080007	(1) BU-1120-A-36-2	080066	(1) BU-5100-A-4-0	100001	(1) BU-6161-N-39-0, (1) BU-6161-N-39-2		
080008	(1) BU-1121-A-36-0	080067	(1) BU-5114-A-4-0	100002	(1) BU-6162-M-39-0, (1) BU-6162-M-39-2		
080009	(1) BU-1121-A-36-2	080068	(1) BU-5120-A-4-0	100003	(1) BU-6162-N-39-0, (1) BU-6162-N-39-2		
080010	(1) BU-1149-A-36-0	080069	(1) BU-5131-A-4-0	100004	(1) BU-6162-N-39-0, (1) BU-6162-N-39-2		
080011	(1) BU-1149-A-36-2	080070	(1) BU-5144-A-4-0	100005	(1) BU-4061-M-39-0, (1) BU-4061-M-39-2		
080012	(1) BU-1150-C-36-0	080071	(1) BU-5200-A-4-0	100006	(1) BU-4061-N-39-0, (1) BU-4061-N-39-2		
080013	(1) BU-1170-C-36-0	080072	(1) BU-5214-A-4-0	100007	(1) BU-4062-N-39-0, (1) BU-4062-N-39-2		
080014	(1) BU-1414-E-36-0	080073	(1) BU-5220-A-4-0	100008	(1) BU-4062-M-39-0, (1) BU-4062-M-39-2		
		080074	(1) BU-5231-A-4-0	100009	(1) BU-6262-M-39-0, (1) BU-6262-M-39-2		
		080075	(1) BU-5244-A-4-0				
		080076	(1) BU-5659-B-36-0				
		080077	(1) BU-1111-A-12-0				
		080078	(1) BU-1111-A-12-2				
		080079	(1) BU-1111-A-24-0				
		080080	(1) BU-1111-A-24-2				
		080081	(1) BU-1111-A-48-0				

Packaged Part #	Bulk Part #	Packaged Part #	Bulk Part #	Packaged Part #	Bulk Part #	Packaged Part #	Bulk Part #
150012	(1) BU-00261	150026	(1) BU-31605-0, (1) BU-31605-2	150040	(1) BU-20434-0		(2) BU-00230-*, (2) BU-00225-*, (2) BU-00207-*
150013	(1) BU-00281-0, (1) BU-00281-2	150027	(1) BU-31606-0, (1) BU-31606-2	150041	(1) BU-20434-2	180000	(10 FT) WI-M-18-0
150014	(1) BU-00282-0, (1) BU-00282-2	150028	(1) BU-32101-0, (1) BU-32101-2	150042	(1) BU-26101-0, (1) BU-26101-2	180001	(10 FT) WI-M-18-2
150015	(1) BU-00201-0, (1) BU-00201-2	150029	(2) BU-00248-0, (2) BU-00248-2	150043	(1) BU-26106-0, (1) BU-26106-2	180002	(10 FT) WI-M-20-0
150016	(1) BU-00202-0, (1) BU-00202-2	150030	(1) BU-00284-0, (1) BU-00284-2	150044	(1) BU-32601-0, (1) BU-32601-2	180003	(10 FT) WI-M-20-2
150017	(1) BU-00203-0, (1) BU-00203-2	150031	(1) BU-00263-0	150045	(2) BU-15-0	180004	(10 FT) WI-M-22-0
150018	(2) BU-00208-0, (2) BU-00208-2	150032	(2) BU-00234-0, (2) BU-00234-2	150046	(2) BU-15-2	180005	(10 FT) WI-M-22-2
150019	(1) BU-31101-0	150033	(1) BU-26130-0, (1) BU-26130-2	150047	(1) JP-29491-2, (1) JP-29591-2	400000	Automotive Kit
150020	(1) BU-31101-2	150034	(1) BU-20431-0	150048	(2) BU-31103-0	400002	Electrical Kit
150021	(1) BU-31102-0	150035	(1) BU-20431-2	150049	(2) BU-31103-2	400003	Electronic Kit
150022	(1) BU-31102-2	150036	(1) BU-20432-0	150050	(4) BU-16-0		
150023	(1) BU-31602-0, (1) BU-31602-2	150037	(1) BU-20432-2	150051	(4) BU-16-2		
150024	(1) BU-31603-0, (1) BU-31603-2	150038	(1) BU-20433-0	150052	(1) BU-00247-2		
150025	(1) BU-31604-0, (1) BU-31604-2	150039	(1) BU-20433-2	150053	(2) BU-60TBO, (2) BU-62-*,		

Mueller Clip/Insulator Reference Chart

CLIP NUMBER	AMPS	WIRE ATTACHMENT	JAW OPENING	USE WITH INSULATOR	WIRE AWG	PLATING
BU-102B-*	300	Lug	6 1/2"	insulated	Up to 0	Copper
BU-102BK-*	300	Lug	6 1/2"	insulated	Up to 0	Copper
BU-102W-*	400	Lug	6 1/2"	insulated	Up to 0	Copper
BU-11APN/WPS	100	Lug	1 5/8"	13	Up to 3/0	Zinc
BU-11CPN/CPS	200	Lug	1 5/8"	13	Up to 3/0	Solid Copper
BU-21APN/APS	50	Crimp/Screw	1 1/16"	23	Up to 8	Zinc
BU-21CPN/CPS	100	Lug	1 1/16"	23	Up to 8	Solid Copper
BU-24APN/WPS	25	Crimp/Screw	3/4"	26	Up to 10	Zinc
BU-25	40	Crimp/Screw	3/4"	26	Up to 10	Zinc
BU-25C	75	Crimp/Screw	3/4"	26	Up to 10	Solid Copper
BU-27	20	Crimp/Screw	5/8"	29/90	Up to 12	Zinc
BU-27C	40	Crimp/Screw	5/8"	29/90	Up to 12	Solid Copper
BU-27CG	40	Crimp/Screw	5/8"	29/90	Up to 12	Solid Copper
BU-27CGW	40	Crimp/Screw	5/8"	29/90	Up to 12	Solid Copper
BU-30	5	Crimp/Solder	3/16"	32	20-24	Nickel
BU-30BL	5	Crimp/Solder	3/16"	31	18-24	Nickel
BU-30C	5	Crimp/Solder	3/16"	32	20-24	Solid Copper
BU-30TBO	5	Threaded	3/16"	31	NA	Nickel
BU-33C	300	Lug	1 13/16"	35	Up to 300MCM	Solid Copper
BU-34	5	Crimp/Solder	7/32"	36	20-24	Nickel
BU-34C	5	Crimp/Solder	7/32"	36	20-24	Copper
BU-40A-*	15	Crimp/Solder	3/4"	insulated	Up to 12	Nickel
BU-40C-*	20	Crimp/Solder	3/4"	insulated	Up to 12	Copper
BU-41A-*	200	Crimp/Solder	1 9/16"	insulated	Up to 1	Copper
BU-41C-*	400	Crimp/Solder	1 9/16"	insulated	Up to 1	Solid Copper
BU-45	5	Crimp/Screw	5/16"	47	16-22	Zinc
BU-45C	10	Crimp/Screw	5/16"	47	16-22	Solid Copper
BU-46A-*	50	Crimp/Solder	1 1/8"	insulated	Up to 10	Copper
BU-46C-*	75	Crimp/Solder	1 1/8"	insulated	Up to 10	Solid Copper
BU-48B	10	Crimp/Screw	1/2"	49	14-20	Zinc
BU-48B2E	10	Crimp	1/2"	49	14-20	Zinc
BU-48C	20	Crimp/Screw	1/2"	49	14-20	Solid Copper
BU-50C	20	Crimp/Screw	1/2"	49	14-18	Solid Copper
BU-51C	20	Crimp/Screw	1/2"	49	14-18	Solid Copper
BU-55	10	Crimp/Screw	7/16"	49	14-20	Zinc
BU-60	10	Crimp/Solder/Plug-on	5/16"	62	14-20	Nickel
BU-60C	10	Crimp/Solder/Plug-on	5/16"	62	14-20	Solid Copper

CLIP NUMBER	AMPS	WIRE ATTACHMENT	JAW OPENING	USE WITH INSULATOR	WIRE AWG	PLATING
BU-60CHS	10	Crimp/Screw	5/16"	Insul. Barrel	14-20	Solid Copper
BU-60CS	10	Crimp/Screw	5/16"	62	14-20	Solid Copper
BU-60H	10	Crimp/Solder	5/16"	Insul. Barrel	14-20	Nickel
BU-60HS	10	Crimp/Screw	5/16"	Insul. Barrel	14-20	Nickel
BU-60HPR	10	Pin/Prod Tip	5/16"	Insul. Barrel	NA	Nickel
BU-60PR2	10	Pin/Prod Tip	5/16"	62	NA	Nickel
BU-60S	10	Crimp/Screw	5/16"	62	14-20	Nickel
BU-60TBO	10	Threaded	5/16"	62	NA	Nickel
BU-60U	10	Crimp/Solder	5/16"	62	14-20	Nickel
BU-60X	10	Crimp/Solder/Plug-On	5/16"	62	14-20	Stainless Steel
BU-61	10	Pin/Prod Tip	5/16"	62	NA	Nickel
BU-63	10	Crimp/Screw	1/4"	Insulated	14-20	Nickel
BU-63C	10	Crimp/Screw	1/4"	Insulated	14-20	Solid Copper
BU-65-*	30	Plug-on	3/4"	Insulated	NA	Nickel
BU-651-*	10	Plug-On	17/64"	insulated	NA	Nickel
BU-652-*	20	Plug-On	17/64"	insulated	NA	Nickel
BU-654-*	20	Plug-On	1"	insulated	NA	Nickel
BU-656-*	30	Plug-On	51/64"	insulated	NA	Nickel
BU-70	5	Crimp/Solder	5/16"	72	16-20	Nickel
BU-70C	10	Crimp/Solder	5/16"	72	16-20	Copper
BU-70CS	10	Crimp/Screw	5/16"	72	16-20	Copper
BU-70S	5	Crimp/Screw	5/16"	72	16-20	Nickel
BU-75K	10	Screw	5/16"	Insulated	NA	Silver
BU-78K	10	Solder	1/2"	None	NA	Gold
BU-85	5	Crimp/Screw	5/16"	87	14-20	Zinc
BU-85C	10	Crimp/Screw	5/16"	87	14-20	Solid Copper
BU-95	10	Crimp/Screw	7/16"	74	14-20	Zinc
BU-X15400-*	400	Crimp	1 1/2"	insulated	Up to 1	Copper Jaws
JP-25182	5	Crimp/Screw	1"	8681	Up to 10	Nickel/Silver
JP-33699	5	Crimp/Screw	1"	8681	Up to 10	Nickel/Silver
JP-33674	5	Crimp/Screw	1"	8681	Up to 10	Nickel/Silver
JP-5869-B	20	Crimp/Screw	5/8"	29/90	Up to 12	Zinc
JP-5869-C	20	Crimp/Screw	5/8"	29/90	Up to 12	Zinc
JP-8078	5	Crimp/Screw	1"	8681	Up to 10	Nickel/Silver
JP-8099	5	Crimp/Screw	1"	8681	Up to 10	Nickel/Silver
JP-8783	5	Crimp/Screw	1"	8681	Up to 10	Nickel/Silver