

- Up to **20 W, 1A** switching
- **1 Form A** (SPST) or **2 Form A** (DPST) N.O.
- **1 Form A** stacks on **0.15 x 0.27** inches pitch
- Instrumentation grade switches with sputtered ruthenium contacts making them ideal for low level or “cold” switching applications
- Plastic package with internal mu-metal magnetic screen
- Take up minimum board area of only **0.15 x 0.27** inches; making it possible to increase the functionality of existing designs without increasing the size of PCB
- Insulation resistance $>10^{12} \Omega$
- **3, 5** or **12 V** coils with optional internal back E.M.F suppression diode
- **Additional build options are available**
- Many benefits compared to industry standard relays (see last page)
- Suitable for high density instrumentation applications such as A.T.E. switching matrices or multiplexers.

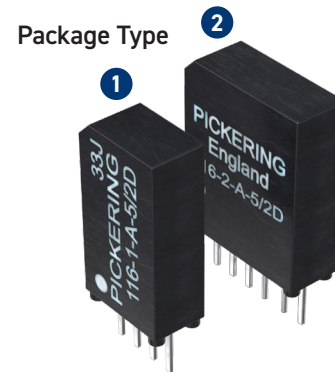

The relays feature an internal mu-metal magnetic screen. Mu-metal has the advantage of a high permeability and low magnetic remanence and eliminates problems that would otherwise occur due to magnetic interaction. Interaction is usually measured as a percentage increase in the voltage required to operate a relay when additional relays, stacked each side, are themselves operated. An unscreened device mounted on this pitch would have an interaction figure of around 40%. Relays of this size without magnetic screening would therefore be totally unsuitable for applications where dense packing is required. To learn more visit: pickeringrelay.com/magnetic-interaction

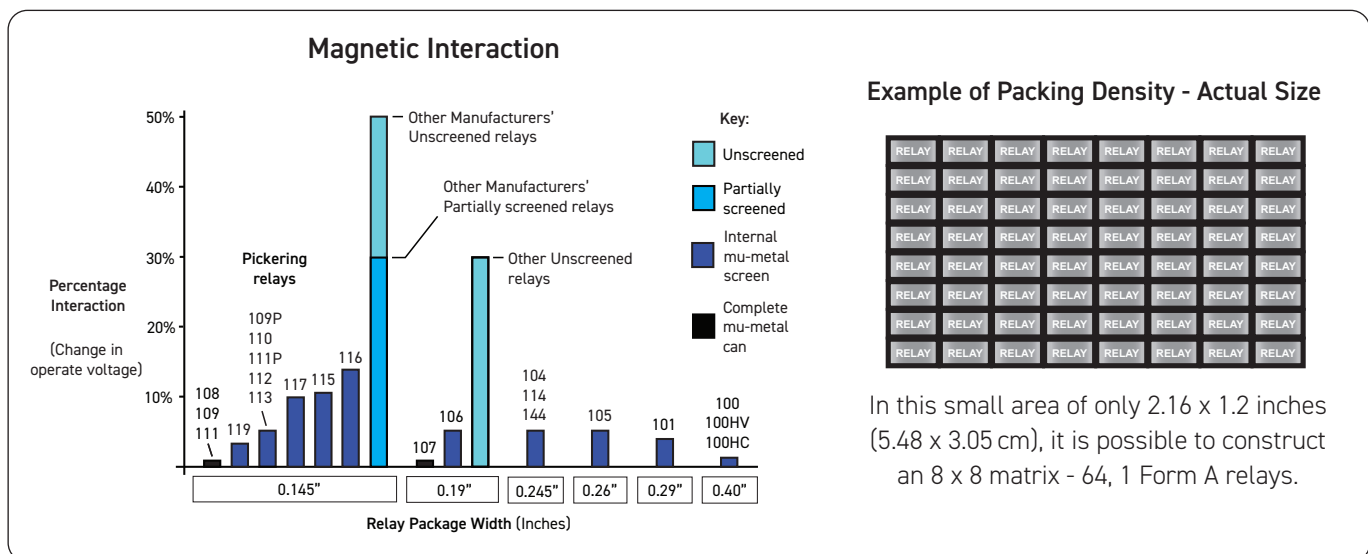

Switch Ratings - Dry Switches

1 Form A (energize to make)	2 Form A (energize to make)
20 W at 200 V	20 W at 200 V
15 W at 200 V	15 W at 200 V
10 W at 200 V	10 W at 200 V

Series 116 switch ratings - contact ratings for each switch type

Switch No	Switch form	Power rating	Max. switch current	Max. carry current	Max. switching volts	Life expectancy ops typical (see Note ¹)	Operate time inc bounce (max)	Release time	Special features
1	A	20 W (*15 W for 3 & 5 V coils)	1 A	1 A	200 V	10 ⁸	0.5 ms	0.2 ms	General Purpose
2	A	10 W	0.5 A	0.5 A	200 V	10 ⁸	0.5 ms	0.2 ms	Low level

Switch no.2 is particularly good for switching low currents and/or voltages. It is the ideal switch for A.T.E. systems where cold switching techniques are often used. Where higher power levels are involved, switch no.1 is more suitable.

Note!: Life Expectancy

The life of a reed relay depends upon the switch load and end of life criteria. For example, for an 'end of life' contact resistance specification of 1Ω, switching low loads (10V at 10 mA resistive) or when 'cold' switching, typical life is approx 2.5 x 10⁸ ops. At the maximum load (resistive), typical life is 1 x 10⁶ ops. In the event of abusive conditions, e.g. high currents due to capacitive inrushes, this figure reduces considerably. Pickering will be pleased to perform life testing with any particular load condition.

Operating Voltages

Coil voltage - nominal	Must operate voltage - maximum at 25 °C	Must release voltage - minimum at 25 °C
3 V	2.25 V	0.3 V
5 V	3.75 V	0.5 V
12 V	9 V	1.2 V

Environmental Specification/Mechanical Characteristics

In the table below, the upper temperature limit can be extended to +125 °C if the coil drive voltage is increased to accommodate the resistance/temperature coefficient of the copper coil winding. This is approximately 0.4% per °C. This means that at 125 °C the coil drive voltage will need to be increased by approximately 40 x 0.4 =16% to maintain the required magnetic drive level. Please contact sales@pickeringrelay.com for assistance.

Operating Temperature Range	-20 °C to +85 °C
Storage Temperature Range	-35 °C to +100 °C
Shock Resistance	50 g
Vibration Resistance (10 - 2000 Hz)	20 g
Soldering Temperature (max) (10 s max)	270 °C
Washability (Proper drying process is recommended)	Fully Sealed

Washing Guidelines

Pickering do not make any specific recommendations on washing reed relays, due to the large number of factors in cleaning processes, however we do have suggestions on best practices. Click [here](#) for more information.

Dry Relay: Series 116 Coil data and type numbers

Device Type	Type Number	Coil (V)	Coil resistance	Max. contact resistance (initial)	Insulation resistance (minimum at 25 °C) (see Note ⁴)		Capacitance (typical) (see Note ^{2, 3})	
					Switch to coil	Across switch	Closed switch to coil	Across open switch
1 Form A, Switch No. 1 Package Type 1 (* 15 W for 3 & 5 V coils)	116-1-A-3/1D *	3	250 Ω	0.12 Ω	10 ¹² Ω	10 ¹² Ω	2.1 pF	0.2 pF
	116-1-A-5/1D *	5	500 Ω					
	116-1-A-12/1D	12	750 Ω					
1 Form A Switch No. 2 Package Type 1	116-1-A-3/2D	3	250 Ω	0.12 Ω	10 ¹² Ω	10 ¹² Ω	2.1 pF	0.2 pF
	116-1-A-5/2D	5	500 Ω					
	116-1-A-12/2D	12	750 Ω					
2 Form A, Switch No. 1 Package Type 2 (* 15 W for 5 V coils)	116-2-A-5/1D *	5	375 Ω	0.12 Ω	10 ¹² Ω	10 ¹² Ω	2.1 pF	0.2 pF
	116-2-A-12/1D	12	750 Ω					
2 Form A, Switch No. 2 Package Type 2	116-2-A-5/2D	5	375 Ω	0.12 Ω	10 ¹² Ω	10 ¹² Ω	2.1 pF	0.2 pF
	116-2-A-12/2D	12	750 Ω					

When an internal diode is required, the suffix D is added to the part number as shown in the table.

Note²: Switch to Coil Capacitance

Due to the asymmetrical internal construction of the relay, the capacitance to the coil from one switch connection is approximately half the capacitance of the other switch connection, pin 3 is lower. In some applications this feature may be used to advantage for example, in a multiplexer where it is desirable to minimize the capacitance of the common connection to maximize bandwidth.

Note³: Capacitance across open switch

The capacitance across the open switch was measured with other connections guarded.

Note⁴: Insulation resistance

Insulation resistance will reduce at higher temperatures. For more information on temperature effects [click here](#), or [contact Pickering](#) for more in depth guidance.

The technical information shown in this data sheet could contain inaccuracies or typographical errors. This information may be periodically changed or updated and these changes will be included in future versions of this data sheet.

For different values, latest specifications and product details, please contact your local Pickering sales office.

For **FREE** evaluation samples go to: pickeringrelay.com/samples

Pin Configuration, Weights and Dimensional Data (dimensions in inches, millimeters in brackets)

Package Type 1

Weight: Typical 0.53 g

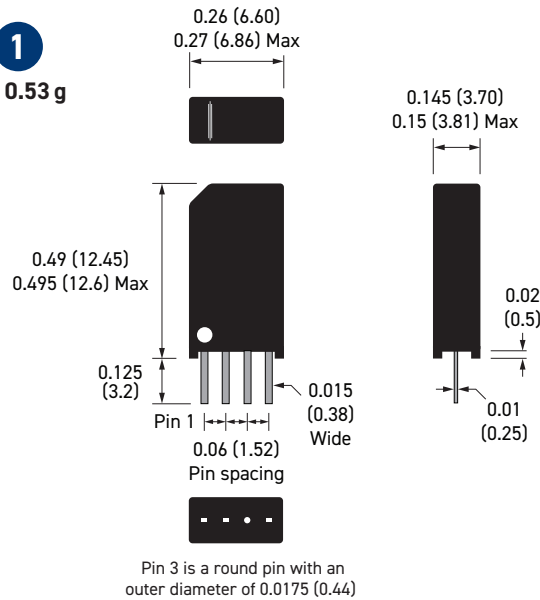

1 Form A

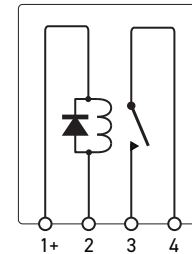

Package Type 2

Weight: Typical 0.76 g

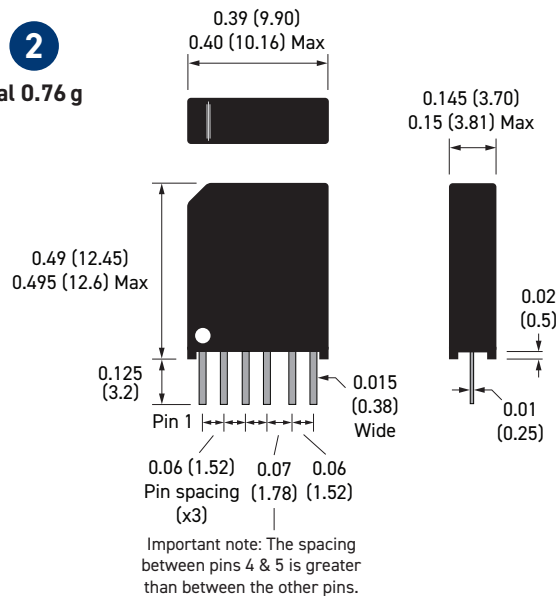



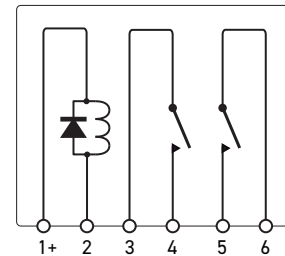

2 Form A





Important: Where the optional internal diode is fitted the correct coil polarity must be observed, as shown by the + symbol on the schematics.

Similar Relays Comparison

If the Series 116 is unsuitable for your application, Pickering also manufactures two other series of reed relays with similar characteristics, but in different package sizes.

Series Name		117-1-A	117-2-A	116-1-A		116-2-A	
Physical Outline							
Depth	mm (inches)	3.7 (0.145))	3.7 (0.145)	3.7 (0.145))		3.7 (0.145)	
Width		6.6 (0.26)	9.9 (0.39)	6.6 (0.26)		9.9 (0.39)	
Height		9.52 (0.375)	9.52 (0.375)	12.45 (0.49)		12.45 (0.49)	
Package Volume (mm ³)		233	349	① 304		② 456	
Typical Weights (g)		0.38	0.64	0.53		0.76	
Contact Configuration		1-A (SPST)	2-A (DPST)	1-A (SPST)		2-A (DPST)	
Reed Switch Type		Dry	Dry	Dry		Dry	
Stand-off Voltage (V)		-	-	-		-	
Switching Voltage (V)		170	170	200	200	200	200
Switching Current (A)		0.5	0.5	1.0	0.5	1.0	0.5
Carry Current (A)		0.5	0.5	1.0	0.5	1.0	0.5
Switch Power (W)		10	10	20 (15)	10	20 (15)	10

Series Name		115-1-A		115-2-A	
Physical Outline					
Depth	mm (inches)	3.7 (0.145)		3.7 (0.145)	
Width		6.6 (0.26)		9.9 (0.39)	
Height		15.5 (0.61)		15.5 (0.61)	
Package Volume (mm ³)		379		568	
Typical Weights (g)		0.66		0.91	
Contact Configuration		1-A (SPST)		2-A (DPST)	
Reed Switch Type		Dry	Dry	Dry	
Stand-off Voltage (V)		-	-	-	
Switching Voltage (V)		200	200	200	200
Switching Current (A)		1.0	0.5	1.0	0.5
Carry Current (A)		2.0	1.2	1.2	1.2
Switch Power (W)		20 (15)	10	15	10

Reed Relay Selection Tool

Because Pickering offer the largest range of high-quality reed relays, sometimes it can be difficult to find the right reed relay you require. That is why we created the Reed Relay Selector, this tool will help you narrow down our offering to get you the correct reed relay for your application. To try the tool today go to: pickeringrelay.com/reed-relay-selector-tool

Standard Build Options

The Series 116 Reed Relays are available with a number of standard build options to tailor them to your specific application. These options are detailed in the table below. If you decide to go ahead and specify one, or more, of these options you will be allocated a unique part number suffix.

Mechanical Build Options	Electrical Build Options
Special pin configurations or pin lengths	Different coil resistance
Special print with customer's own part number or logo	Operate or de-operate time
Custom packaging possibility	Pulse capability
	Enhanced specifications
	Non-standard coil voltages and resistance figures
	Special Life testing under customer's specific load conditions
	Specific environmental requirements
	Controlled thermal EMF possibility

Customization

If your specific requirements are not met by standard relay, or any of the standard build options, please speak to us to discuss producing a customized reed relay to service your specific application: pickeringrelay.com/contact

3D Models

Interactive 3D models of the complete range of Pickering relay products in STEP, IGS and SLDPRN formats can be downloaded from the website: pickeringrelay.com/3d-models

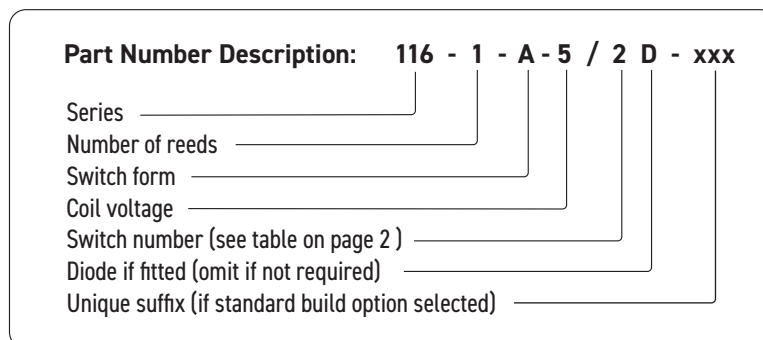

Help

If you need any technical advice or other help, please do not hesitate to contact our Technical Sales Department. We will always be pleased to discuss Pickering relays with you. email: techsales@pickeringrelay.com

Contact Us

UK Headquarters - email: sales@pickeringrelay.com | Tel. +44 1255 428141

USA - email: ussales@pickeringrelay.com | Tel. +1 781 897 1710

Germany - email: desales@pickeringtest.com | Tel. +49 89 125 953 160

France - email: frsales@pickeringtest.com | Tel. +33 9 72 58 77 00

Nordic - email: ndsales@pickeringtest.com | Tel. +46 340 69 06 69









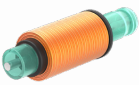
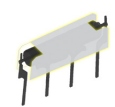
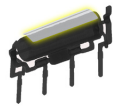

Czech Republic: czsales@pickeringtest.com | Tel. +420 558-987-613

China - email: chinasales@pickeringtest.com | Tel. +86 4008 799 765

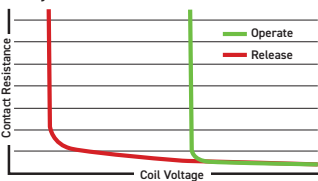
For a full list of agents, distributors and representatives visit: pickeringrelay.com/agents

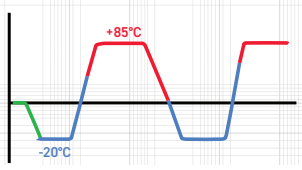

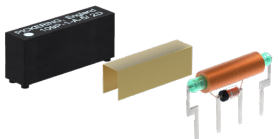
10 Key Benefits of Pickering Reed Relays

Key Benefit	Pickering Reed Relays	Typical Industry Reed Relays	
1 Instrumentation Grade Reed Switches	Instrumentation Grade Reed Switches with vacuum sputtered Ruthenium plating to ensure stable, long life up to 5x10E9 operations.	Often low grade Reed Switches with electroplated Rhodium plating resulting in higher, less stable contact resistance.	
2 Formerless Coil Construction	Formerless coil construction increases the coil winding volume, maximizing magnetic efficiency, allowing the use of less sensitive reed switches resulting in optimal switching action and extended lifetime at operational extremes.	Use of bobbins decreases the coil winding volume, resulting in having less magnetic drive and a need to use more sensitive reed switches which are inherently less stable with greatly reduced restoring forces.	  Pickering former-less coil Typical industry coil wound on bobbin
3 Magnetic Screening	Mu-metal magnetic screening (either external or internal), enables ultra-high PCB side-by-side packing densities with minimal magnetic interaction, saving significant cost and space. Pickering Mu-Metal magnetic screen - interaction approx. 5%	Lower cost reed relays have minimal or no magnetic screening, resulting in magnetic interaction issues causing changes in operating and release voltages, timing and contact resistance, causing switches to not operate at their nominal voltages. Typical industry screen - interaction approx. 30%	  X-Ray of Pickering mu-metal magnetic screen X-Ray of typical industry magnetic screen
4 SoftCenter™ Technology	SoftCenter™ technology, provides maximum cushioned protection of the reed switch, minimising internal lifetime stresses and extending the working life and contact stability.	Transfer moulded reed relays (produced using high temperature/pressure), result in significant stresses to the glass reed switch which can cause the switch blades to deflect or misalign leading to changes in the operating characteristics, contact resistance stability and operating lifetime.	  Pickering soft center protection of the reed switch Typical industry thermo-setting hard moulded protection of the reed switch
5 100% Dynamic Testing	100% testing for all operating parameters including dynamic contact wave-shape analysis with full data scrutiny to maintain consistency.	Simple dc testing or just batch testing which may result in non-operational devices being supplied.	Dynamic Contact Resistance Test 
6 100% Inspection at Every Stage of Manufacturing	Inspection at every stage of manufacturing maintaining high levels of quality.	Often limited batch inspection.	
7 100% Thermal Cycling	Stress testing of the manufacturing processes, from -20 °C to +85 °C to -20 °C, repeated 3 times.	Rarely included resulting in field failures.	
8 Flexible Manufacturing Process	Flexible manufacturing processes allow quick-turn manufacturing of small batches.	Mass production: Usually large batch sizes and with no quick-turn manufacturing.	
9 Custom Reed Relays	Our reed relays can be customized easily, e.g. special pin configurations, enhanced specifications, non-standard coil or resistance figures, special life testing, low capacitance, and more.	Limited ability to customize.	
10 Product Longevity	Pickering are committed to product longevity; our reed relays are manufactured and supported for more than 25 years from introduction, typically much longer.	Most other manufacturers discontinue parts when they reach a low sales threshold; costing purchasing and R&D a great deal of unnecessary time and money to redesign and maintain supply.	

For more information go to: pickeringrelay.com/10-key-benefits