

### 3. Install the Display

a. For VESA 200x100

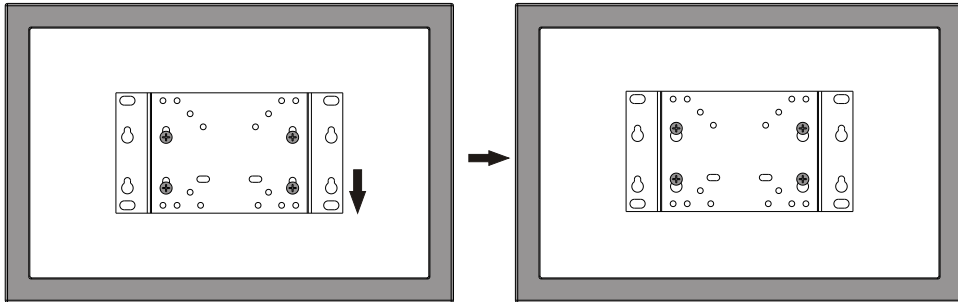

b. For VESA 100x100 75x75 50x50

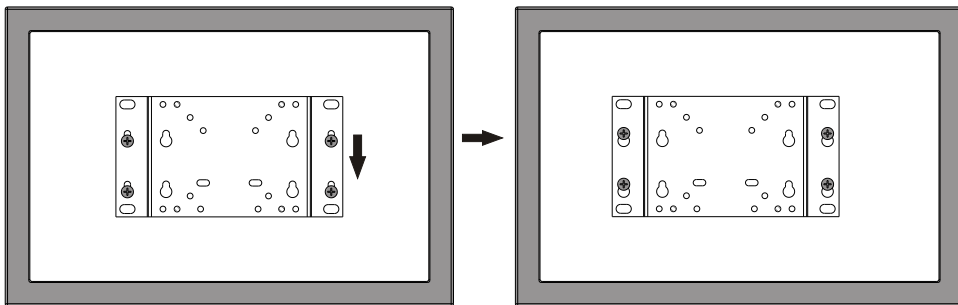

Align holes of VESA plate to screws in wall and lower the VESA plate until the screws are seated in upper area of tear-drop mounting holes.

#### Maintenance

- Check that the bracket is secure and safe to use at regular intervals (at least every three months).
- Please contact your dealer if you have any questions.

# PRO-SIGNAL

## INSTALLATION INSTRUCTIONS

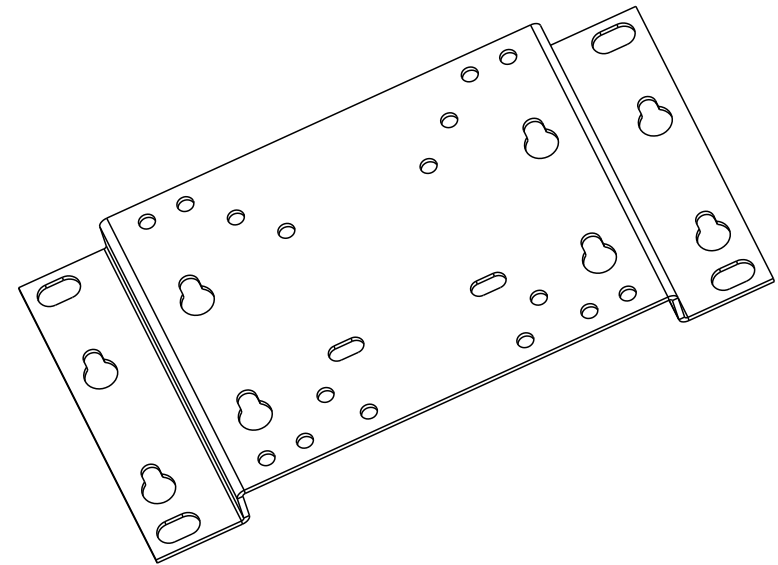

### Ultra-slim Fixed Wall Mount



**CAUTION: DO NOT EXCEED MAXIMUM LISTED WEIGHT CAPACITY. SERIOUS INJURY OR PROPERTY DAMAGE MAY OCCUR!**

PSG03390



50x50/75x75  
100x100/200x100

32"  
MAX



ISSUED: OCT. 2012

**NOTE:** Read the entire instruction manual before you start installation and assembly.

## WARNING

- Do not begin the installation until you have read and understood the instructions and warnings contained in this installation sheet. If you have any question regarding any of the instructions or warnings, please contact your local distributor.
- This mounting bracket was designed to be installed and utilized **ONLY** as specified in this manual. Improper installation of this product may cause damage or serious injury.
- This product should only be installed by someone of good mechanical ability, with basic building experience and fully understanding of this manual.
- Make sure that the supporting surface will safely support the combined load of the equipment and all attached hardware and components.
- Always use assistant or mechanical lifting equipment to safely lift and position equipment.
- Tighten screws firmly, but do not over tighten. Over tightening can damage the items, greatly reducing their holding power.
- This product is intended for indoor use only. Using this product outdoors could lead to product failure and personal injury.

## Component Checklist

**IMPORTANT:** Ensure that you have received all parts according to the component checklist prior to installing. If any parts are missing or faulty, contact the seller for a replacement.

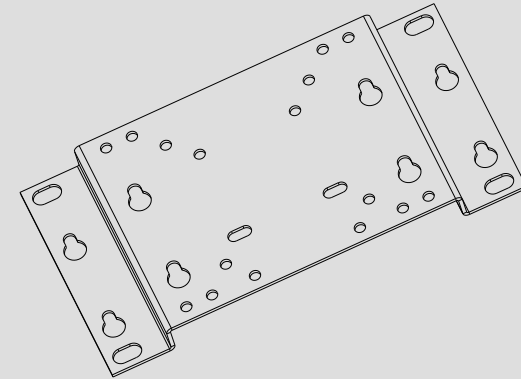

VESA plate (x1)

### Package M



M4x14 (x4)  
M-A

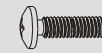

M5x14 (x4)  
M-B

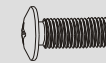

M6x14 (x4)  
M-C



M8x20 (x4)  
M-D



D5 washer (x4)  
M-E



D8 washer (x4)  
M-F



small spacer (x8)  
M-G

### Package W



ST4.8x50 (x4)  
W-A

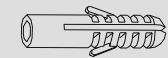

concrete anchor (x4)  
W-B

# 1. Mount on Solid Brick and Concrete Block

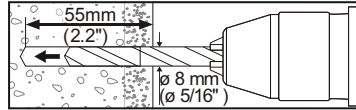
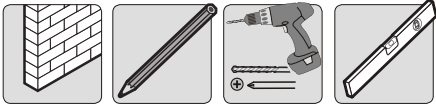

## a. For VESA 200x100

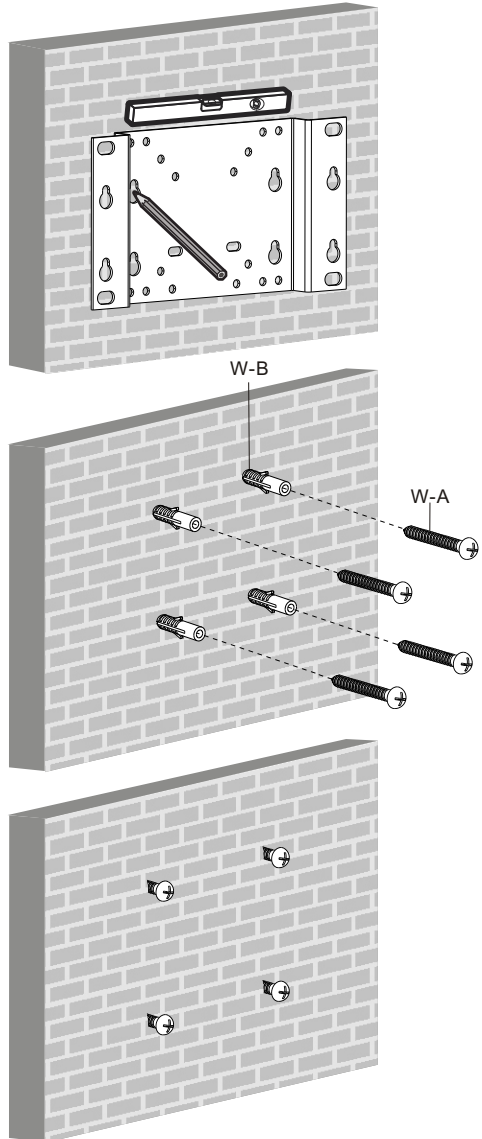

Mark the exact location of mounting holes

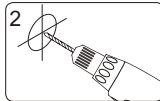

Drill pilot holes

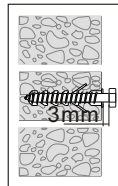
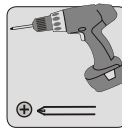
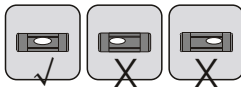

Tighten the screws spacing 3mm to wall plate.

## b. For VESA 100x100 75x75 50x50

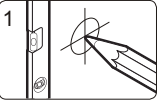
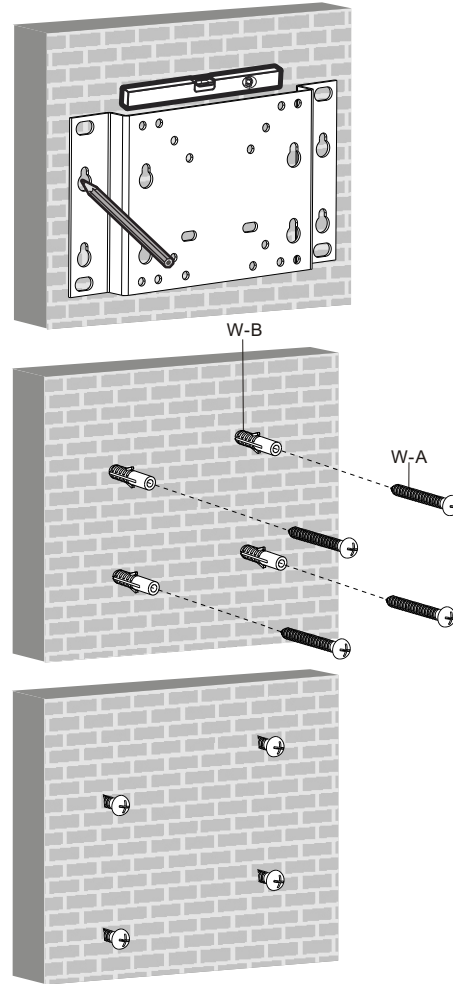

Mark the exact location of mounting holes

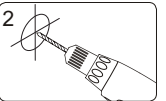

Drill pilot holes

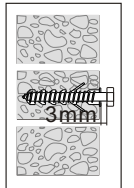
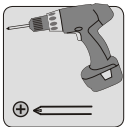

Tighten the screws spacing 3mm to wall plate.

## ⚠ WARNING

- When installing wall mounts on cinder block, verify the actual concrete thickness is at least 1-3/8" (35mm) for using the concrete anchors. Do not drill into mortar joints! Be sure to mount in a solid part of the block, generally 1" (25mm) minimum from the side of the block. It is suggested electric drill on slow setting be used to drill the hole instead of a hammer drill to avoid breaking out the back of the hole when entering a void or cavity.
- Installers must verify that the supporting surface will safely support the combined load of the equipment and all attached hardware and components.

## 2. Install VESA Plate

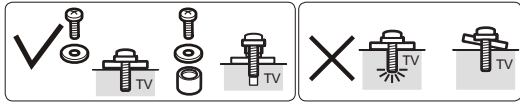

a. For VESA 200x100

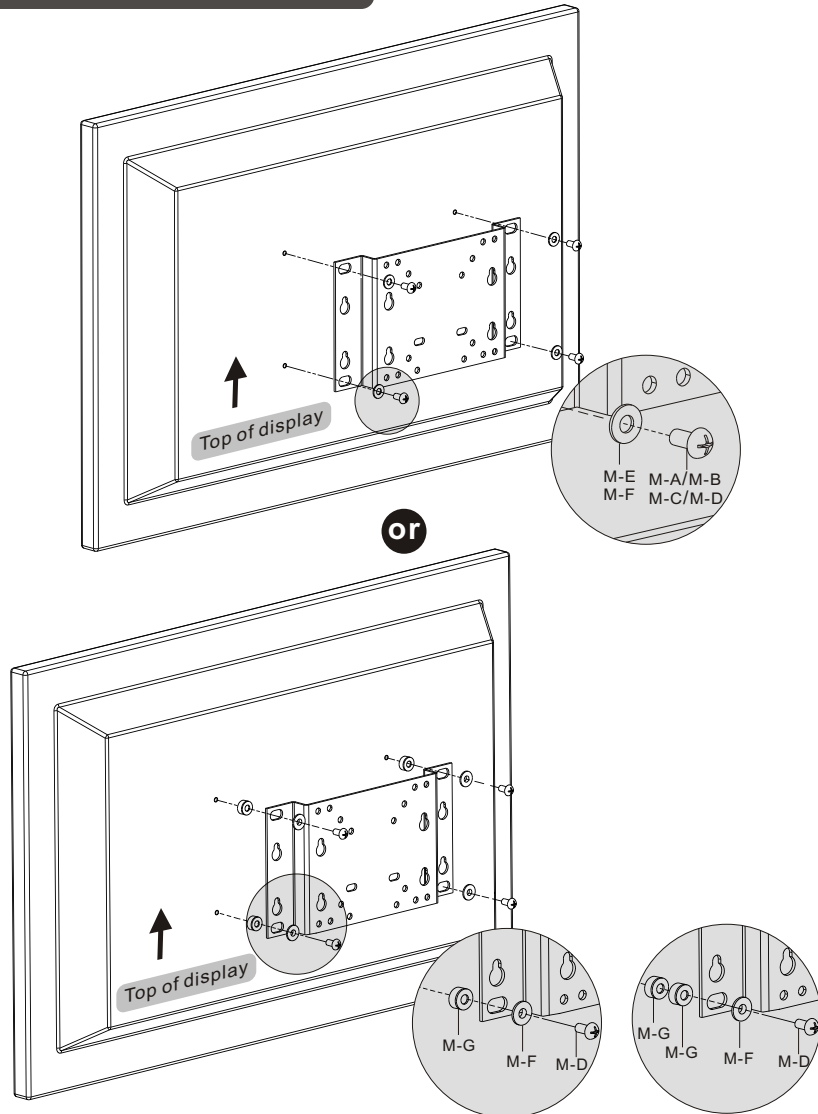

b. For VESA 100x100 75x75 50x50

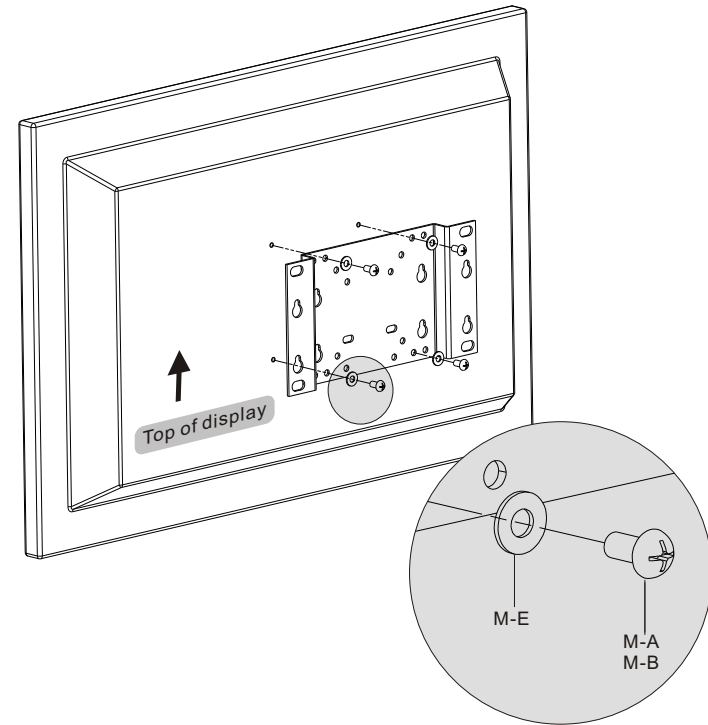

**Note:** Choose appropriate screws, washers and spacers (if necessary) according to the type of screen. Screw VESA plate onto the display.

 **Tighten all screws but do not over tighten.**