

HOMECLICK METAL

160 x 80 x 40 cm* (63.0"x31.5"x15.8")

KIT MINI 4/400
Color

5 Años Garantía
Years Guarantee
Jahre Garantie
Ans Garantie
Anos de Garantia
SIMONRACK

600 kg
(1400 lb)
Total



160 cm (63.0")

40 cm (15.8")

80 cm (31.5")



*MEDIDAS EN USO: 1604 x 804 x 404 mm
USED MEASUREMENTS: 63.15" x 31.65" x 15.91"



ESTANTERIAS SIMON S.L. B.50.556.463
PG. ALFAMEN C/ POLIGONO C, Nº3
ALFAMEN (ZARAGOZA)

Simon Rack
SINCE 1964 - MANUFACTURER

www.simonrack.com



www.simonrack.com



INSTRUCTIONS

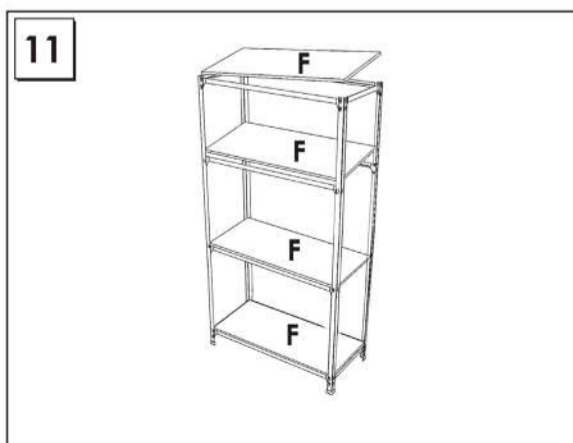
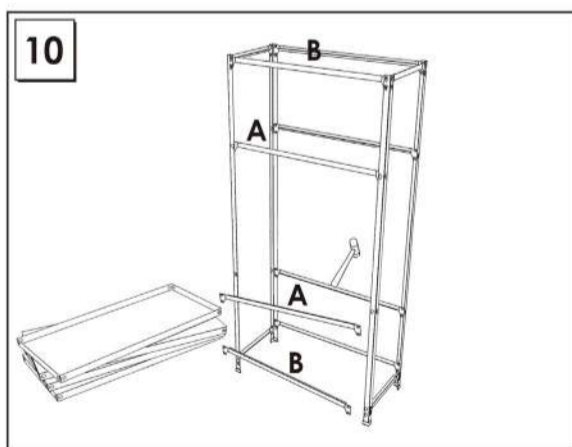
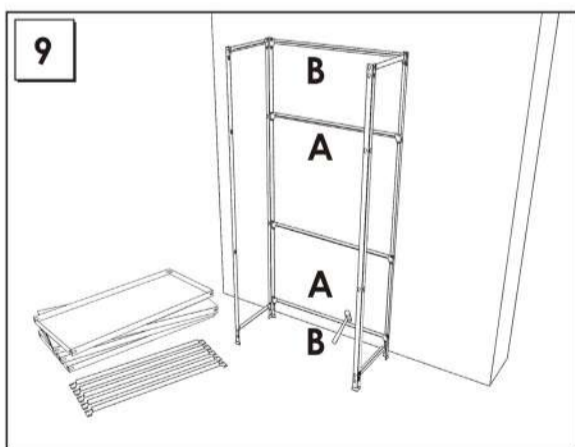
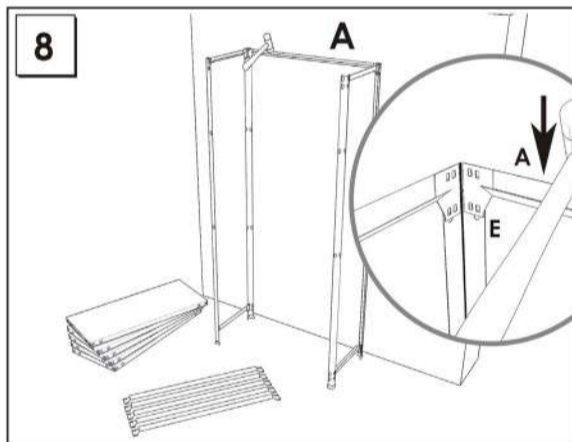
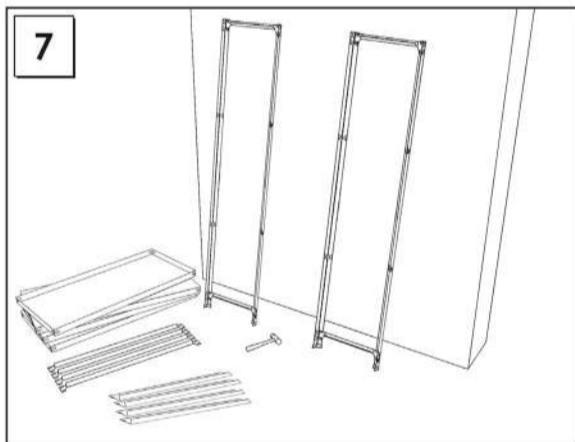
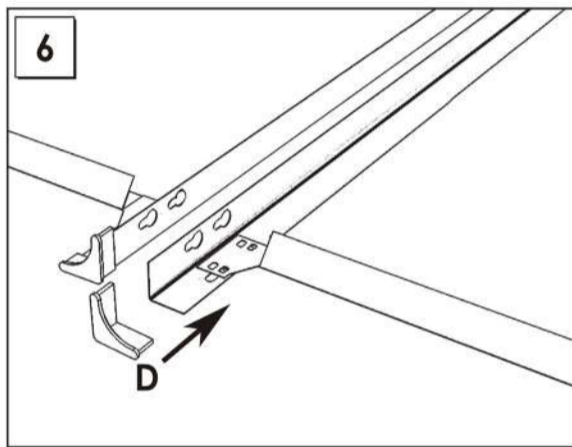
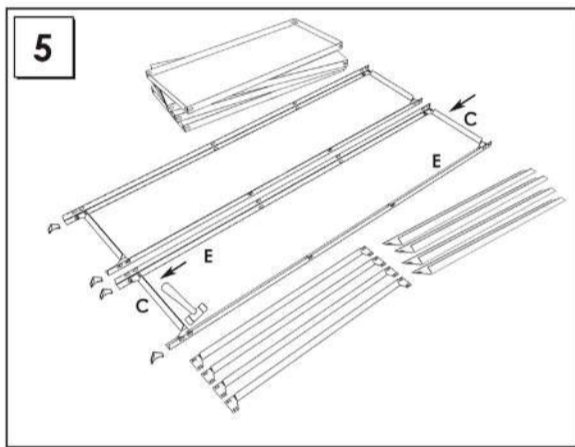
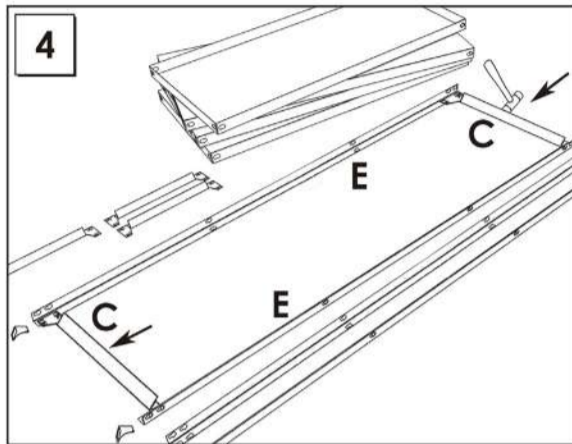
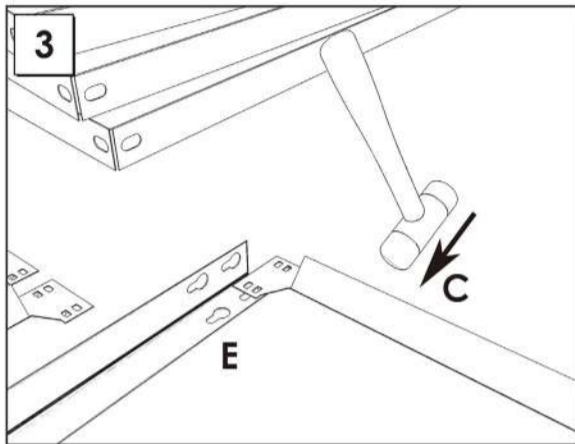
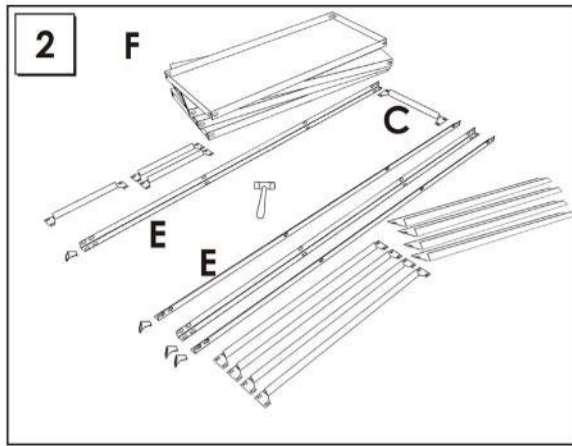
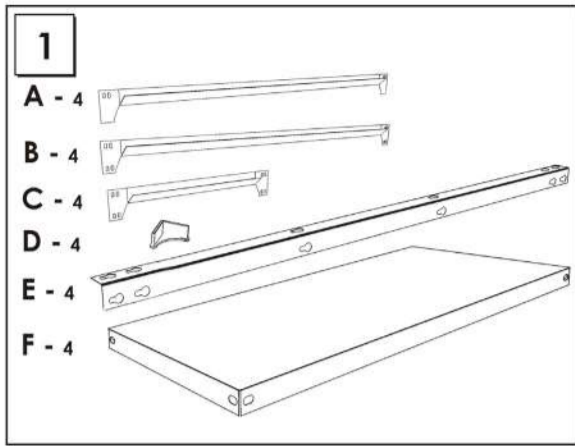

SIMONCLASSIC



SIMONCLICK



SIMONOFFICE



SIMONTALLER



**BANCOS DE TRABAJO
WORK BENCHES**



SIMONHOME



**TAQUILLAS
LOCKER**



SIMONTITÁN



SIMONINOX



SIMONPALET



SIMONLEVER



**ALTILLOS Y PASILLOS ELEVADOS
PLATFORMS AND MEZZANINES**

