

AS-i Safety Input Modules (M12), IP67

for optoelectronic protective devices,
floating contacts or
complementary switch

Applications up to category 4/PLe/SIL 3



(Figure similar)



Figure	Type	Inputs Safety, SIL 3, cat. 4	Outputs digital	Safety signal inputs	Input voltage (sensor supply.) (1)	Output voltage (actuator supply.) (2)	AS-i connection (3)	AS-i address (4)	Special function	Article no.
	IP67, 4 x M12, Safety	2 x 2 channels	-	floating contacts	out of AS-i	-	AS-i profile cable	2 single slaves	-	BWU2631
	IP67, 4 x M12, Safety	1 x 2 channels	2 x electronic	floating contacts	out of AS-i	out of AUX	AS-i profile cable	1 single slave	-	BWU2284
	IP67, 4 x M12, Safety	1 x 2 channels	2 x electronic	floating contacts	out of AS-i	out of AUX	AS-i using M12	1 single slave	-	BWU2369
	IP67, 4 x M12, Safety	1 x 2 channels	2 x electronic	optoelectronic protective devices	out of AUX	out of AUX	AS-i profile cable	1 single slave	-	BWU2270
	IP67, 4 x M12, Safety	1 x 2 channels	2 x electronic	optoelectronic protective devices	out of AUX	out of AUX	AS-i profile cable	1 single slave	reset output for optoelectronic protective devices	BWU2689
	IP67, 4 x M12, Safety	1 x 2 channels	2 x electronic	optoelectronic protective devices	out of AUX	out of AUX	AS-i using M12	1 single slave	-	BWU2370
	IP67, 4 x M12, Safety	1 x 2 channels	2 x electronic	optoelectronic protective devices	out of AS-i	out of AS-i	AS-i using M12	1 single slave	-	BWU2960
	IP67, 4 x M12, Safety	1 x 2 channels	2 x electronic	complementary switch	out of AS-i	out of AUX	AS-i profile cable	1 single slave	-	BWU2814

- (1) **Input voltage (sensor supply):** inputs are supplied by AS-i or by AUX (auxiliary 24 V power). If supplied by AS-i, inputs shall not be connected to earth or to external potential.
- (2) **Output voltage (actuator supply):** outputs are supplied by AS-i or by AUX (auxiliary 24 V power). If supplied by AS-i, outputs shall not be connected to earth or to external potential
- (3) **AS-i connection:** the connection to AS-i as well to AUX (auxiliary 24V power) is either made via yellow resp. black AS-i profile cable with piercing technology or via M12 socket (in IP20 via clamps).
- (4) **AS-i address:** 1 AB Slave (max. 62 AB Slaves/AS-i network), 2 AB Slaves (max. 31 modules with 2 AB Slaves), Single Slaves (max. 31 Single Slaves/AS-i network), mixed use allowed.
For modules with two slaves the second slave is turned off as long as the first slave is addressed to address "0".
Upon request, slaves are available with specific AS-i Slave profiles.

Article no.	BWU2270	BWU2370	BWU2689	BWU2960
Connection				
AS-i/AUX connection	profile cable and piercing	M12	profile cable and piercing	M12
Periphery connection	M12			
Length of connector cable	unlimited ⁽¹⁾			
AS-i				
Profile	S-7.B.1, ID1=F			
Voltage	22 ... 31,6 V			
Max. current consumption	60 mA			
AUX				
Voltage	24 V (20 ... 30 V _{DC}) (PELV)			–
Max. current consumption	4 A max.			–
Input				
Number	1 x 2 channel safe input for OSSDs			
Safe input	OSSD			
Power supply	out of AUX			out of AS-i
Input level	V _{in} > 11 V for High-Level, Input current > 2,5 mA at 15 V			
OSSD test pulses	0 ... 50 Hz			
OSSD test pulse width	U _{aux} ≥ 21,5 V = 0 ... 1 ms test pulses possible U _{aux} ≥ 17 V = 0 ... 0,8 ms test pulses possible U _{aux} < 17 V = 0 ... 0,6 ms			
Start delay	<22 ms			
Output				
Number	2, electronic			
Power supply	out of AUX			out of AS-i
Max. output current	1 A per output			∑ = 50mA
Display				
LEDs S1, S2 (yellow)	state of inputs OSSD1, OSSD2			
LEDs O1, O2 (O3) (yellow)	state of outputs O1, O2		state of outputs O2, O3	state of outputs O1, O2
LED AUX (green)	24 V _{DC} AUX on			–
LED ASI (green)	AS-i voltage on			
LED FLT/FAULT (red)	LED on: AS-i communication error, slave does not participate in the normal exchange of data, e.g. slave address 0 LED flashing: peripheral fault ⁽²⁾			

Article no.	BWU2270	BWU2370	BWU2689	BWU2960
Environment				
Applied standards	EN ISO 13849-1 PLe Kat4 EN ISO 13849-2 EN 62061 SIL 3 EN 62026-2 EN 61000-6-2 EN 61000-6-4 EN 61131-2 EN 60529			
Operating altitude	max. 2000 m			
Ambient temperature	-30 °C ... +70 °C ⁽³⁾ , no condensation permitted			
Storage temperature	-25 °C ... +85 °C			
Housing	plastic, for DIN rail mounting	plastic, for screw mounting	plastic, for DIN rail mounting	plastic, for screw mounting
Protection category	IP67			
Maximum tolerable shock and vibration stress	≤15g, T≤11 ms 10 ... 55 Hz, 0,5 mm amplitude			
Weight	100 g			
Dimensions (W / H / D in mm)	45 / 80 / 42	45 / 116,5 / 47,5	45 / 80 / 42	45 / 116,5 / 47,5

(1) loop resistance ≤150 Ω

(2) See table „Peripheral fault indication“

(3) Temperature range up to -30°C from Ident.No. ≥16292 (BWU2270); Ident.No. ≥16294 (BWU2370); Ident.No. ≥16293 (BWU2689); Ident.No. ≥16369 (BWU2960)

Article no.	BWU2814	BWU2284	BWU2369	BWU2631
Connection				
AS-i/AUX connection	profile cable and piercing		M12	profile cable and piercing
Periphery connection	M12			
Length of connector cable	I/O: max. 15 m ⁽¹⁾			
AS-i				
Profile	S-7.B.0, ID1=F			S1: S-7.B.0, ID1=F S2: S-7.B.0, ID1=E
Voltage	22 ... 31,6 V			
Max. current consumption	80 mA			
AUX				
Voltage	24 V (20 ... 30 V _{DC}) (PELV)			–
Max. current consumption	3 A max.			–
Input				
Number	1 x 2 channel safe input for floating contacts			2 x 2 channel safe inputs for floating contacts
Safe input	non-equivalent switch	floating contacts		
Switching current	–	15 mA (T = 100 μs), continuously 4 mA at 24 V		
Power supply	out of AS-i			
Input level	10 mA, R≤150 Ω			
Output				
Number	2, electronic			–
Power supply	out of AUX			–
Max. output current	1 A per output			–

Article no.	BWU2814	BWU2284	BWU2369	BWU2631
Display				
LEDs S1, S2 (S3, S4) (yellow)	state of inputs S1, S2		state of inputs S1.1,S1.2; S2.1, S2.2	
LEDs O1, O2 (yellow)	state of outputs O1, O2		–	
LED AUX (green)	24 V _{DC} AUX on		–	
LED ASI (green)	AS-i voltage on			
LED FLT/FAULT (red)	LED on: AS-i communication error, slave does not participate in the normal exchange of data, e.g. slave address 0 LED flashing: peripheral fault ⁽²⁾			
Environment				
Applied standards	EN ISO 13849-1 PLe Kat4 EN ISO 13849-2 EN 62061 SIL 3 EN 62026-2 EN 61000-6-2 EN 61000-6-4 EN 61131-2 EN 60529			
Operating altitude	max. 2000 m			
Ambient temperature	0 °C ... +70 °C, no condensation permitted	-30 °C ... +70 °C ⁽³⁾ , no condensation permitted		
Storage temperature	-25 °C ... +85 °C			
Housing	plastic, for DIN rail mounting	plastic, for screw mounting	plastic, for DIN rail mounting	
Protection category	IP67			
Maximum tolerable shock and vibration stress	≤15g, T≤11 ms 10 ... 55 Hz, 0,5 mm amplitude			
Weight	100 g			
Dimensions (W / H / D in mm)	45 / 80 / 42	45 / 116,5 / 47,5	45 / 80 / 42	

(1) loop resistance ≤150 Ω

(2) See table „Peripheral fault indication“

(3) Temperature range up to -30°C from Ident.No. ≥16286 (BWU2369); Ident.No. ≥16295 (BWU2631)

Article no.	Peripheral fault indication		
	cross connection S1 to S2	output overload	AUX voltage missing
BWU2270	–	•	•
BWU2689	–	•	•
BWU2284	•	•	–
BWU2814	•	•	–
BWU2369	•	•	–
BWU2370	–	•	•
BWU2631	•	–	–
BWU2960	–	•	–

Programming	AS-i bit assignment			
	D0	D1	D2	D3
	Safe input			
BWU2284 / BWU2369 / BWU2631	S1	S1	S2	S2
BWU2814	S1	S1	S2 denied	S2 denied
BWU2270 / BWU2370 / BWU2689 / BWU2960	OSSD1	OSSD1	OSSD2	OSSD2
	Output			
BWU2270 / BWU2284 / BWU2369 / BWU2370 / BWU2631 / BWU2814 / BWU2960	O1	O2	not used	
BWU2689	not used	O2	O3	not used

Programming	AS-i bit assignment			
	Parameter bit			
	P0	P1	P2	P3
BWU2270 / BWU2370 / BWU2689 / BWU2960	Watchdog (0 = off / 1 = on)		not used	
BWU2284 / BWU2631 / BWU2369 / BWU2814	not used			

Pin assignment

Connections							
Article no.	M12 connection	Marking	Pin1	Pin2	Pin3	Pin4	Pin5
BWU2270	X1	S1	24V _{ext out}	OSSD2	0V _{ext out}	OSSD1	shield
	X2	S2	24V _{ext out}	n.c.	0V _{ext out}	24V _{ext out}	shield
	X3	O1	n.c.	Out2	0V _{ext out}	Out1	n.c.
	X4	O2	n.c.	n.c.	0V _{ext out}	Out2	n.c.
	X5	ADDR	connection for AS-i addressing device				
BWU2284	X1	S1	S1+	S1-	S2+	S2-	n.c.
	X2	S2	S2+	S2-	n.c.	n.c.	n.c.
	X3	O1	n.c.	Out2	0V _{ext out}	Out1	n.c.
	X4	O2	n.c.	n.c.	0V _{ext out}	Out2	n.c.
	X5	ADDR	connection for AS-i addressing device				
BWU2631	X1	S1	S1.1+	S1.1-	S1.2+	S1.2-	n.c.
	X2	S2	S1.2+	S1.2-	-	-	n.c.
	X3	S3	S2.1+	S2.1-	S2.2+	S2.2-	n.c.
	X4	S4	S2.2+	S2.2-	-	-	n.c.
	X5	F1/F2 ADDR	connection for AS-i addressing device (Slave 1: above, Slave 2: below)				
BWU2689	X1	S1	24V _{ext out}	OSSD2	0V _{ext out}	OSSD1	Out3
	X2	S2	24V _{ext out}	n.c.	0V _{ext out}	24V _{ext out}	shield
	X3	O3	n.c.	Out2	0V _{ext out}	n.c.	n.c.
	X4	O2	n.c.	Out3	0V _{ext out}	Out2	n.c.
	X5	ADDR	connection for AS-i addressing device				
BWU2814	X1	S1	NC contact		NO contact		n.c.
			S1+	S1-	S2+	S2-	
	X2	S2	NO contact		NC contact		n.c.
			S2+	S2-	S1+	S1-	
	X3	O1	n.c.	Out2	0V _{ext out}	Out1	n.c.
X4	O2	n.c.	n.c.	0V _{ext out}	Out2	n.c.	
X5	ADDR	connection for AS-i addressing device					

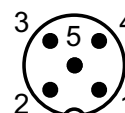
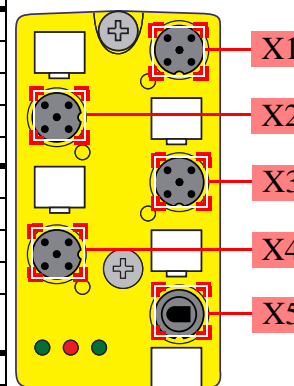

Connections							
Article no.	M12 connection	Marking	Pin1	Pin2	Pin3	Pin4	Pin5
BWU2369	X1	S1	S1+	S1-	S2+	S2-	n.c.
	X2	S2	S2+	S2-	n.c.	n.c.	n.c.
	X3	O1	n.c.	Out2	0V _{ext out}	Out1	n.c.
	X4	O2	n.c.	n.c.	0V _{ext out}	Out2	n.c.
	X5	ASI/ AUX _{ext.in}	AS-i+	0V _{ext in}	AS-i-	+24V _{ext in}	n.c.
BWU2370	X1	S1	24V _{ext out}	OSSD2	0V _{ext out}	OSSD1	shield
	X2	S2	24V _{ext out}	n.c.	0V _{ext out}	24V _{ext out}	shield
	X3	O1	n.c.	Out2	0V _{ext out}	Out1	n.c.
	X4	O2	n.c.	n.c.	0V _{ext out}	Out2	n.c.
	X5	ASI/ AUX _{ext.in}	AS-i+	0V _{ext in}	AS-i-	+24V _{ext in}	n.c.
BWU2960	X1	S1	24V _{out of AS-i}	OSSD2	0V _{out of AS-i}	OSSD1	shield
	X2	S2	24V _{out of AS-i}	n.c.	0V _{out of AS-i}	24V _{out of AS-i}	shield
	X3	O1	n.c.	Out2	0V _{out of AS-i}	Out1	n.c.
	X4	O2	n.c.	n.c.	0V _{out of AS-i}	Out2	n.c.
	X5	ASI	AS-i+	n.c.	AS-i-	n.c.	n.c.

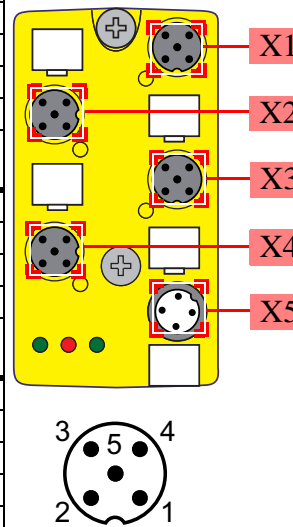

Connection examples BWU2270, BWU2370, BWU2689, BWU2960

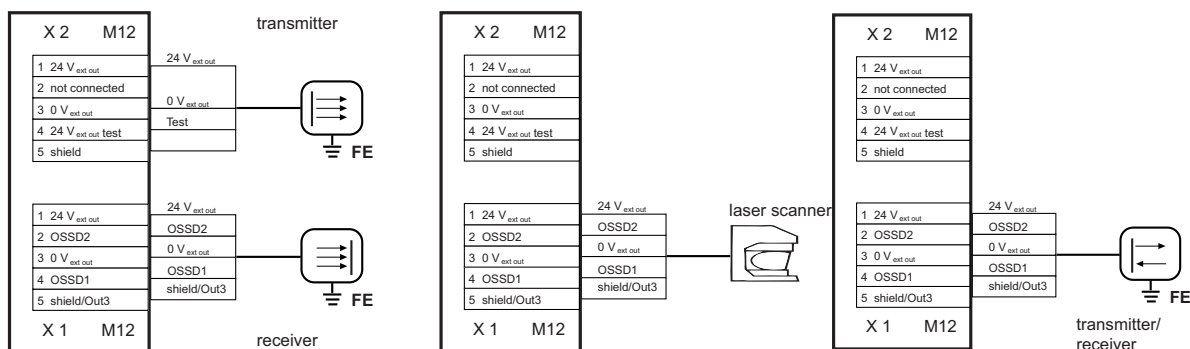

BWU2270, BWU2284, BWU2631, BWU2689, BWU2814:

The matching substructure modules are available as accessories with two different drilling patterns.

BWU2369, BWU2370, BWU2960:

They are supplied including mounted substructure modules (no additional profile cable connection possible)

Mounting according to cable direction

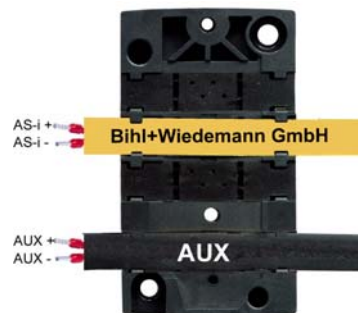

ordinary

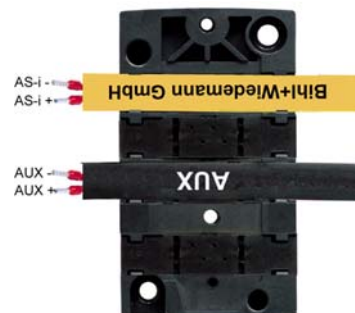

turned

Line termination with sealing profiles / junction

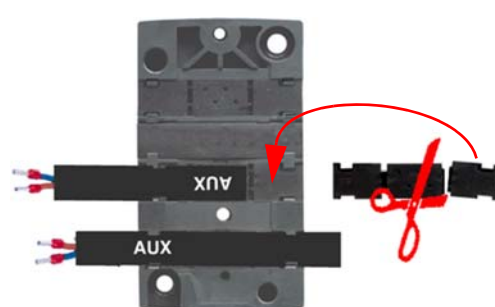
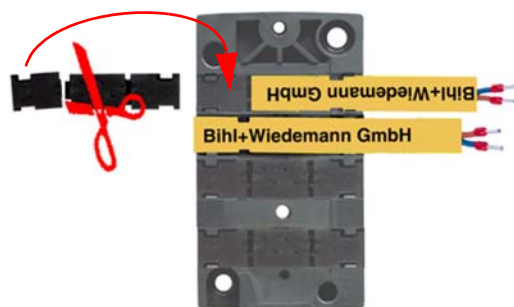
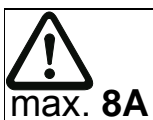

Accessories:

- AS-i substructure module for 4-channel module in 45 mm-housing (article no. BW2349)
- AS-i substructure module (CNOMO) for 4-channel module in 45 mm-housing (article no. BW2350)
- Protection caps for not used M12 sockets (article no. BW2368)