



Part no.: 50127224
AMS 348i 120 H SSI
Optical distance sensor



CDRH



Figure can vary

Contents

- Technical data
- Dimensioned drawings
- Electrical connection
- Operation and display
- Part number code
- Notes
- Accessories

Technical data

| Basic data | |
|----------------------------------|--|
| Series | AMS 300i |
| Application | Collision protection of cranes / gantry cranes Positioning of electroplating plants Positioning of high-bay storage devices Positioning of skilnet systems and side-tracking skates |
| Functions | |
| Functions | Heating |
| Characteristic parameters | |
| MTTF | 31 years |
| Optical data | |
| Light source | Laser , Red |
| Laser class | 2 , IEC/EN 60825-1:2007 |
| Measurement data | |
| Measurement range | 200 ... 120,000 mm |
| Accuracy | 2 mm |
| Reproducibility (3 sigma) | 1.5 mm |
| Max. traverse rate | 10 m/s |
| Electrical data | |
| Performance data | |
| Supply voltage U_B | 18 ... 30 V , DC |
| Interface | |
| Type | PROFINET , SSI |
| Profinet | |
| Conformance class | B |
| Protocol | PROFINET RT |
| Switch functionality | Integrated |
| Transmission speed | 100 Mbit/s |
| SSI | |
| Clock frequency | 80 ... 800 kHz |
| Connection | |
| Number of connections | 5 Piece(s) |
| Connection 1 | |
| Type of connection | Connector |
| Designation on device | BUS IN |
| Function | BUS IN Data interface |
| Thread size | M12 |
| Type | Female |
| No. of pins | 4 -pin |
| Encoding | D-coded |

Connection 2

| | |
|-----------------------|---------------------------|
| Type of connection | Connector |
| Designation on device | BUS OUT |
| Function | BUS OUT Data interface |
| Thread size | M12 |
| Type | Female |
| No. of pins | 4 -pin |
| Encoding | D-coded |

Connection 3

| | |
|-----------------------|-----------------------------------|
| Type of connection | Connector |
| Designation on device | PWR |
| Function | PWR / SW IN/OUT Voltage supply |
| Thread size | M12 |
| Type | Male |
| No. of pins | 5 -pin |
| Encoding | A-coded |

Connection 4

| | |
|-----------------------|-------------------|
| Type of connection | Connector |
| Designation on device | SERVICE |
| Function | Service interface |
| Thread size | M12 |
| Type | Female |
| No. of pins | 5 -pin |
| Encoding | A-coded |

Connection 5

| | |
|-----------------------|-----------------------|
| Type of connection | Connector |
| Designation on device | SSI |
| Function | Data interface SSI |
| Thread size | M12 |
| Type | Male |
| No. of pins | 5 -pin |
| Encoding | B-coded |

Mechanical data

| | |
|-----------------------|---------------------------|
| Design | Cubic |
| Dimension (W x H x L) | 84 mm x 166.5 mm x 159 mm |
| Housing material | Metal |
| Net weight | 2,450 g |
| Type of fastening | Through-hole mounting |

Operation and display

| | |
|----------------------|-------------------|
| Type of display | LC Display LED |
| Operational controls | Membrane keyboard |

Environmental data

| | |
|--------------------------------|---------------|
| Ambient temperature, operation | -30 ... 50 °C |
| Ambient temperature, storage | -30 ... 70 °C |

Part no.: 50127224 – AMS 348i 120 H SSI – Optical distance sensor

| | |
|------------------------------------|------|
| Relative humidity (non-condensing) | 90 % |
|------------------------------------|------|

Certifications

| | |
|----------------------|---------|
| Degree of protection | IP 65 |
| Protection class | III |
| Certifications | c UL US |

Classification

| | |
|-----------------------|----------|
| Customs tariff number | 90318020 |
| eCl@ss 8.0 | 27270801 |
| eCl@ss 9.0 | 27270801 |
| ETIM 5.0 | EC001825 |
| ETIM 6.0 | EC001825 |

Dimensioned drawings

All dimensions in millimeters

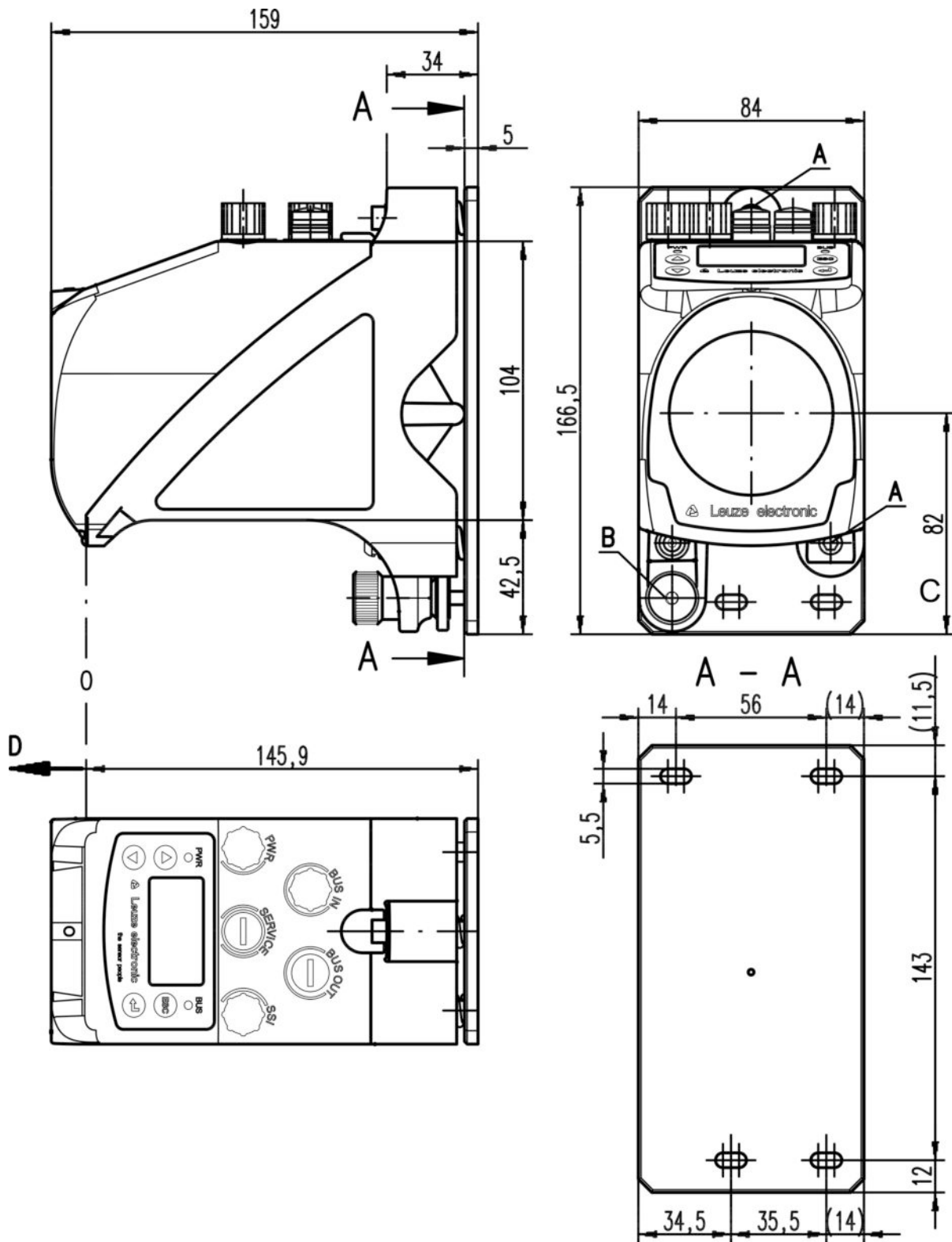

- A M 5 screw for alignment
- B Knurled nut with WAF 4 hexagon socket and M 5 nut for securing
- C Optical axis
- D Zero point of the distance to be measured

Electrical connection

| Connection 1 | BUS IN |
|--------------------|--------------------------|
| Type of connection | Connector |
| Function | BUS IN Data interface |
| Thread size | M12 |
| Type | Female |
| Material | Metal |
| No. of pins | 4 -pin |
| Encoding | D-coded |

| Pin | Pin assignment |
|-----|----------------|
| 1 | TD+ |
| 2 | RD+ |
| 3 | TD- |
| 4 | RD- |

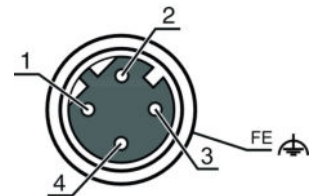

| Connection 2 | BUS OUT |
|--------------------|---------------------------|
| Type of connection | Connector |
| Function | BUS OUT Data interface |
| Thread size | M12 |
| Type | Female |
| Material | Metal |
| No. of pins | 4 -pin |
| Encoding | D-coded |

| Pin | Pin assignment |
|-----|----------------|
| 1 | TD+ |
| 2 | RD+ |
| 3 | TD- |
| 4 | RD- |

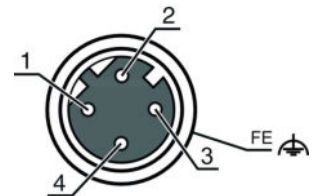

| Connection 3 | PWR |
|--------------------|-----------------------------------|
| Type of connection | Connector |
| Function | PWR / SW IN/OUT Voltage supply |
| Thread size | M12 |
| Type | Male |
| Material | Metal |
| No. of pins | 5 -pin |
| Encoding | A-coded |

Part no.: 50127224 – AMS 348i 120 H SSI – Optical distance sensor

| Pin | Pin assignment |
|-----|----------------|
| 1 | VIN |
| 2 | I/O 1 |
| 3 | GND |
| 4 | I/O 2 |
| 5 | FE |

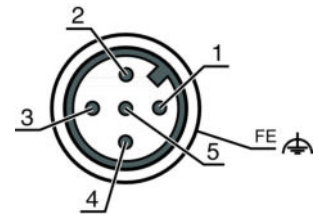

| Connection 4 | SERVICE |
|--------------------|-------------------|
| Type of connection | Connector |
| Function | Service interface |
| Thread size | M12 |
| Type | Female |
| Material | Metal |
| No. of pins | 5 -pin |
| Encoding | A-coded |

| Pin | Pin assignment |
|-----|----------------|
| 1 | n.c. |
| 2 | RS 232-TX |
| 3 | GND |
| 4 | RS 232-RX |
| 5 | n.c. |

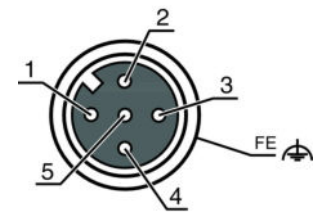

| Connection 5 | SSI |
|--------------------|-----------------------|
| Type of connection | Connector |
| Function | Data interface SSI |
| Thread size | M12 |
| Type | Male |
| Material | Metal |
| No. of pins | 5 -pin |
| Encoding | B-coded |

| Pin | Pin assignment |
|-----|----------------|
| 1 | DATA+ |
| 2 | DATA- |
| 3 | CLK+ |
| 4 | CLK- |
| 5 | FE |

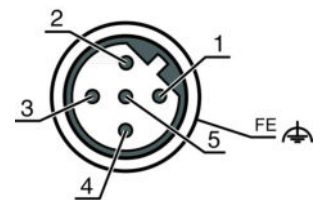

Operation and display

LEDs

| LED | Display | Meaning |
|-----|---------|-------------------|
| 1 | PWR Off | No supply voltage |

| LED | Display | Meaning | |
|-----|--------------------------|--|----------------------------------|
| | Green, flashing | Voltage connected / no measurement value output / initialization running | |
| | Green, continuous light | Device OK, measurement value output | |
| | Red, flashing | Device OK, warning set | |
| | Red, continuous light | No measurement value output | |
| | Orange, flashing | PROFINET wave function activated | |
| | Orange, continuous light | Configuration via display | |
| 2 | BUS | Off | No supply voltage |
| | | Green, flashing | Device ok, initialization phase |
| | | Green, continuous light | Device OK |
| | | Red, flashing | Communication error |
| | | Red, continuous light | Bus error |
| | | Orange, flashing | PROFINET wave function activated |
| 3 | BUS IN | Green, continuous light | Link OK |
| | | Orange, flashing | Data exchange active |
| 4 | BUS OUT | Green, continuous light | Link OK |
| | | Orange, flashing | Data exchange active |

Part number code

Part designation: **AMS 3XXi YYY Z AAA**

| | |
|------|---|
| AMS | Operating principle: AMS: absolute measurement system |
| 3XXi | Series/interface (integrated fieldbus technology): 300i: RS 422/RS 232 301i: RS 485 304i: PROFIBUS DP / SSI 308i: TCP/IP 335i: CANopen 338i: EtherCAT 348i: PROFINET RT 355i: DeviceNet 358i: EtherNet/IP 384i: Interbus |
| YYY | Operating range: 40: max. operating range in m 120: max. operating range in m 200: max. operating range in m 300: max. operating range in m |
| Z | Special equipment: H: with heating |
| AAA | Interface: SSI: with SSI interface |

Note

A list with all available device types can be found on the Leuze electronic website at www.leuze.com.

Notes

Observe intended use!

- This product is not a safety sensor and is not intended as personnel protection.
- The product may only be put into operation by competent persons.
- Only use the product in accordance with its intended use.

WARNING! LASER RADIATION – LASER CLASS 2

Never look directly into the beam!

The device satisfies the requirements of IEC 60825-1:2007 (EN 60825-1:2007) safety regulations for a product of **laser class 2** as well as the U.S. 21 CFR 1040.10 regulations with deviations corresponding to "Laser Notice No. 50" from June 24, 2007.

- Never look directly into the laser beam or in the direction of reflected laser beams! If you look into the beam path over a longer time period, there is a risk of injury to the retina.
- Do not point the laser beam of the device at persons!
- Interrupt the laser beam using a non-transparent, non-reflective object if the laser beam is accidentally directed towards a person.
- When mounting and aligning the device, avoid reflections of the laser beam off reflective surfaces!
- CAUTION! Use of controls or adjustments or performance of procedures other than specified herein may result in hazardous light exposure.
- Observe the applicable statutory and local laser protection regulations.
- The device must not be tampered with and must not be changed in any way.
There are no user-serviceable parts inside the device.
Repairs must only be performed by Leuze electronic GmbH + Co. KG.

NOTE

Affix laser information and warning signs!



Laser information and warning signs are affixed to the device. In addition, self-adhesive laser information and warning signs (stick-on labels) are supplied in several languages.

- Affix the laser information sheet to the device in the language appropriate for the place of use. When using the device in the US, use the stick-on label with the "Complies with 21 CFR 1040.10" note.
- Affix the laser information and warning signs near the device if no signs are attached to the device (e.g. because the device is too small) or if the attached laser information and warning signs are concealed due to the installation position.
- Affix the laser information and warning signs so that they are legible without exposing the reader to the laser radiation of the device or other optical radiation.

- For UL applications, use is only permitted in Class 2 circuits in accordance with the NEC (National Electric Code).
- Use as safety-related component within the safety function is possible, if the component combination is designed correspondingly by the machine manufacturer.

Accessories



Connection technology - Connection cables

| | Part no. | Designation | Article | Description |
|---|----------|------------------------|------------------|---|
|  | 50104171 | KB SSI/ IBS-5000-BA | Connection cable | Suitable for interface: SSI, Interbus-S Connection 1: Connector, M12, Axial, Female, B-coded, 5 -pin Connection 2: Open end Shielded: Yes Cable length: 5,000 mm Sheathing material: PUR |
|  | 50132079 | KD U-M12-5A- V1-050 | Connection cable | Connection 1: Connector, M12, Axial, Female, A-coded, 5 -pin Connection 2: Open end Shielded: No Cable length: 5,000 mm Sheathing material: PVC |

Part no.: 50127224 – AMS 348i 120 H SSI – Optical distance sensor

| | Part no. | Designation | Article | Description |
|---|----------|---------------------|------------------|--|
|  | 50135074 | KS ET-M12-4A-P7-050 | Connection cable | Suitable for interface: Ethernet Connection 1: Connector, M12, Axial, Male, D-coded, 4 -pin Connection 2: Open end Shielded: Yes Cable length: 5,000 mm Sheathing material: PUR |



Reflective tapes for distance sensors

| | Part no. | Designation | Article | Description |
|---|----------|-------------------------|-----------------|---|
|  | 50115021 | Reflexfolie 500x500mm-H | Reflector | Supply voltage: 230 V, AC Design: Rectangular Reflective surface: 500 mm x 500 mm Base material: Aluminum Fastening: Mounting plate, Through-hole mounting Special design: Heating |
|  | 50104362 | Reflexfolie 500x500mm-S | Reflective tape | Design: Rectangular Reflective surface: 500 mm x 500 mm Chemical designation of the material: PMMA Fastening: Adhesive |

Deflecting mirror

| | Part no. | Designation | Article | Description |
|---|----------|-------------|-------------------|--|
|  | 50104479 | US AMS 01 | Deflecting mirror | Type of fastening: Through-hole mounting |

Services

| | Part no. | Designation | Article | Description |
|---|----------|-------------|------------------|---|
|  | S981001 | CS10-S-110 | Start-up support | Details: Performed at location of customer's choosing, duration: max. 10 hours. Conditions: Devices and connection cables are already mounted, price not including travel costs and, if applicable, accommodation expenses. Restrictions: No mechanical (mounting) and electrical (wiring) work performed, no changes (attachments, wiring, programming) to third-party components in the nearby environment. |
|  | S981005 | CS10-T-110 | Product training | Details: Location and content to be agreed upon, duration: max. 10 hours. Conditions: Price not including travel costs and, if applicable, accommodation expenses. Restrictions: Travel costs and accommodation expenses charged separately and according to expenditure. |

Note

A list with all available accessories can be found on the Leuze electronic website in the Download tab of the article detailed page.