

## Base strip - MSTBA 2,5/12-G-5,08 - 1757349

Please be informed that the data shown in this PDF Document is generated from our Online Catalog. Please find the complete data in the user's documentation. Our General Terms of Use for Downloads are valid (<http://phoenixcontact.com/download>)

Header, Nominal current: 12 A, Rated voltage (III/2): 320 V, Number of positions: 12, Pitch: 5.08 mm, Color: green, Contact surface: Tin, Mounting: Wave soldering



The figure shows a 10-position version of the product

### Why buy this product

- ✓ Maximum flexibility when it comes to device design – one header for connectors with different connection technologies
- ✓ Well-known mounting principle allows worldwide use
- ✓ Plug-in direction parallel to the PCB
- ✓ Closed contour for optimum stability of the plug-in connection



### Key Commercial Data

Packing unit	50 STK
GTIN	
GTIN	4017918029876
Weight per Piece (excluding packing)	4.000 g
Custom tariff number	85366990
Country of origin	Germany

### Technical data

#### Dimensions

Length	12 mm
Pitch	5.08 mm
Dimension a	55.88 mm
Width	62.88 mm
Constructional height	8.6 mm
Height	12.1 mm
Length of the solder pin	3.5 mm
Pin dimensions	1 x 1 mm

# Base strip - MSTBA 2,5/12-G-5,08 - 1757349

## Technical data

### Dimensions

Hole diameter	1.4 mm
---------------	--------

### General

Range of articles	MSTBA 2,5/...-G
Insulating material group	I
Rated surge voltage (III/3)	4 kV
Rated surge voltage (III/2)	4 kV
Rated surge voltage (II/2)	4 kV
Rated voltage (III/3)	250 V
Rated voltage (III/2)	320 V
Rated voltage (II/2)	400 V
Connection in acc. with standard	EN-VDE
Nominal current $I_N$	12 A
Maximum load current	12 A
Insulating material	PA
Flammability rating according to UL 94	V0
Color	green
Number of positions	12

### Standards and Regulations

Connection in acc. with standard	EN-VDE
	CSA
Flammability rating according to UL 94	V0

### Environmental Product Compliance

China RoHS	Environmentally friendly use period: unlimited = EFUP-e
	No hazardous substances above threshold values

## Drawings

Drilling diagram

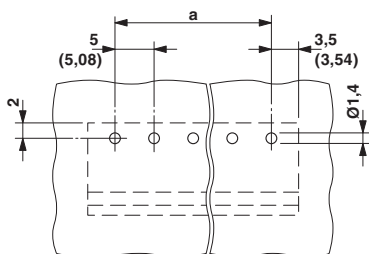

Diagram

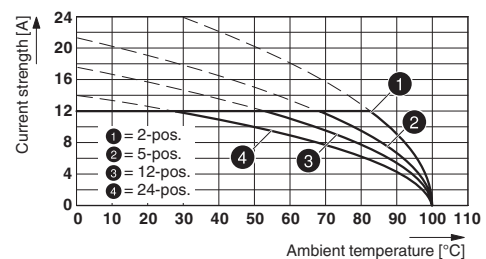

Type: ICV 2,5/...-G-5,08 with MSTBA 2,5/...-G-5,08

# Base strip - MSTBA 2,5/12-G-5,08 - 1757349

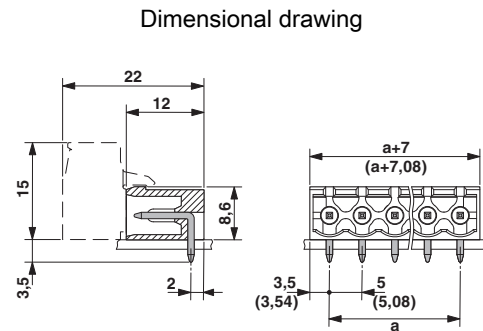
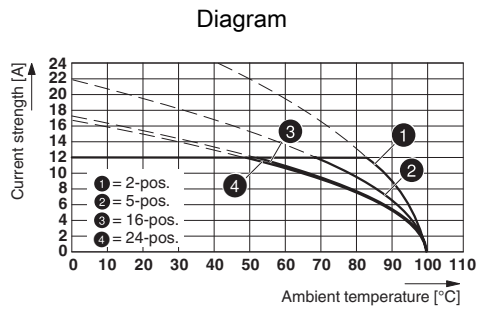

Type: IC 2,5/...-G-5,08 with MSTBA 2,5/...-G-5,08

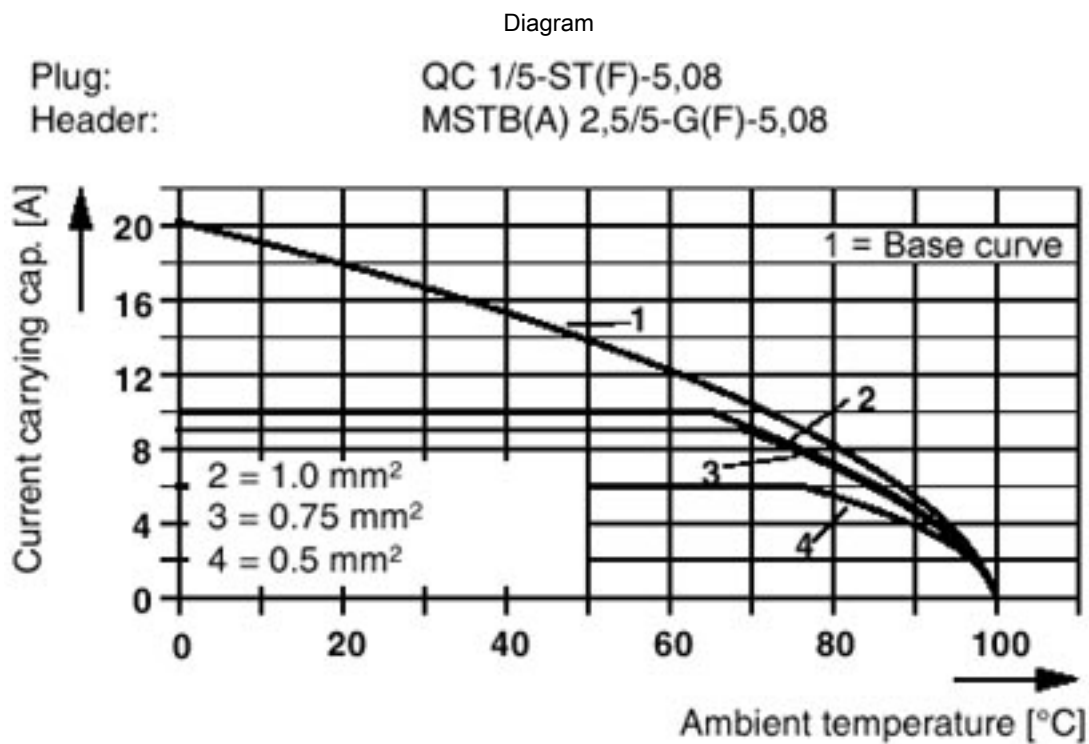

# Base strip - MSTBA 2,5/12-G-5,08 - 1757349

Diagram

Plug: MSTBT 2,5/5-ST(F)-(-5,08)  
Header: MSTB(A) 2,5/5-G(F)-(-5,08)

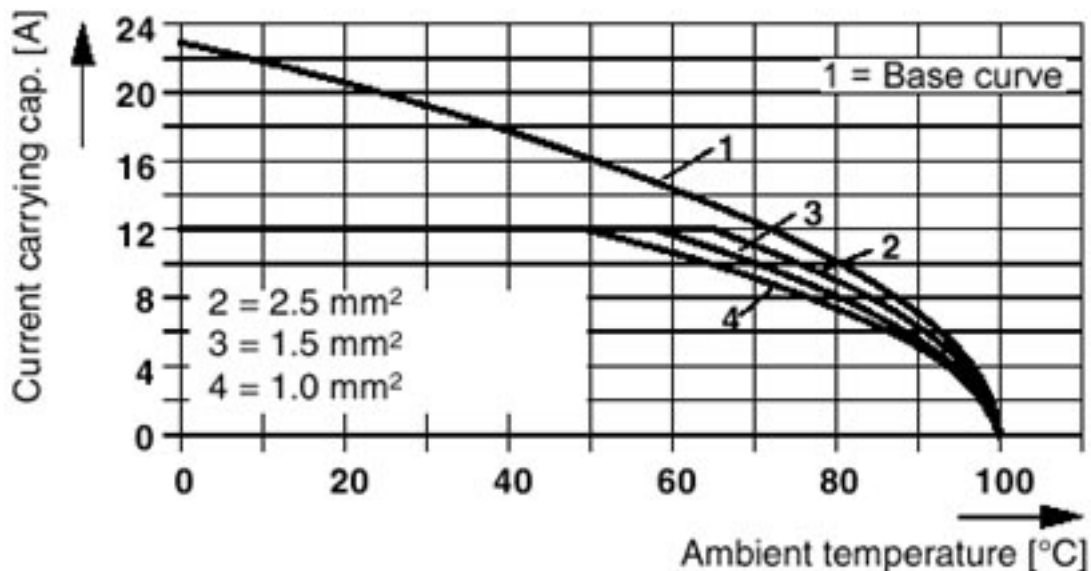

Diagram

Plug: SMSTB 2,5/5-ST(F)-(-5,08)  
Header: MSTB(A) 2,5/5-G(F)-(-5,08)

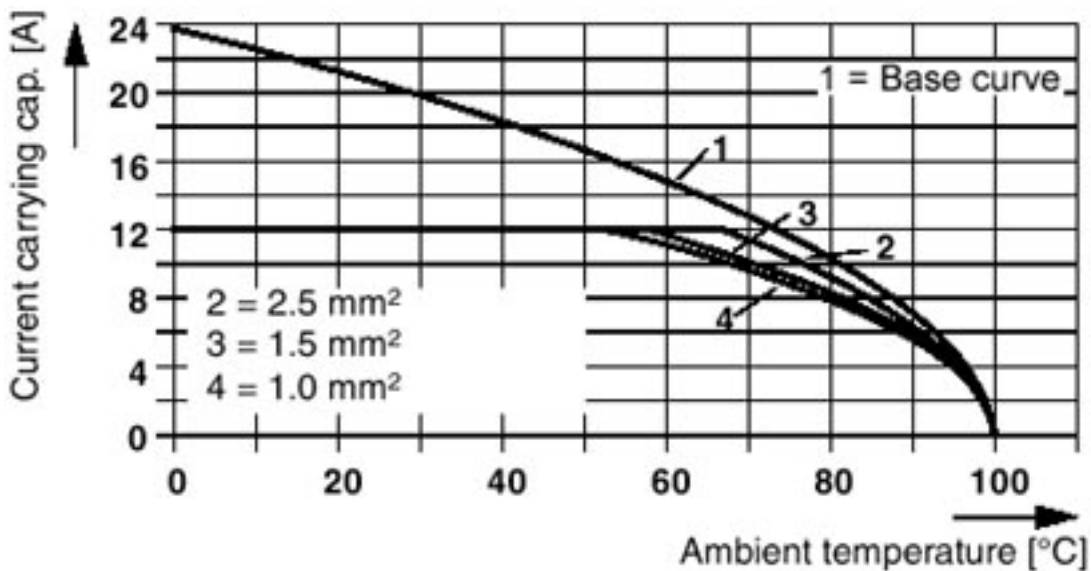

# Base strip - MSTBA 2,5/12-G-5,08 - 1757349

Diagram

Plug: MVSTBR(W) 2,5/5-ST(F)-(-5,08)  
Header: MSTB(A) 2,5/5-G(F)-(-5,08)

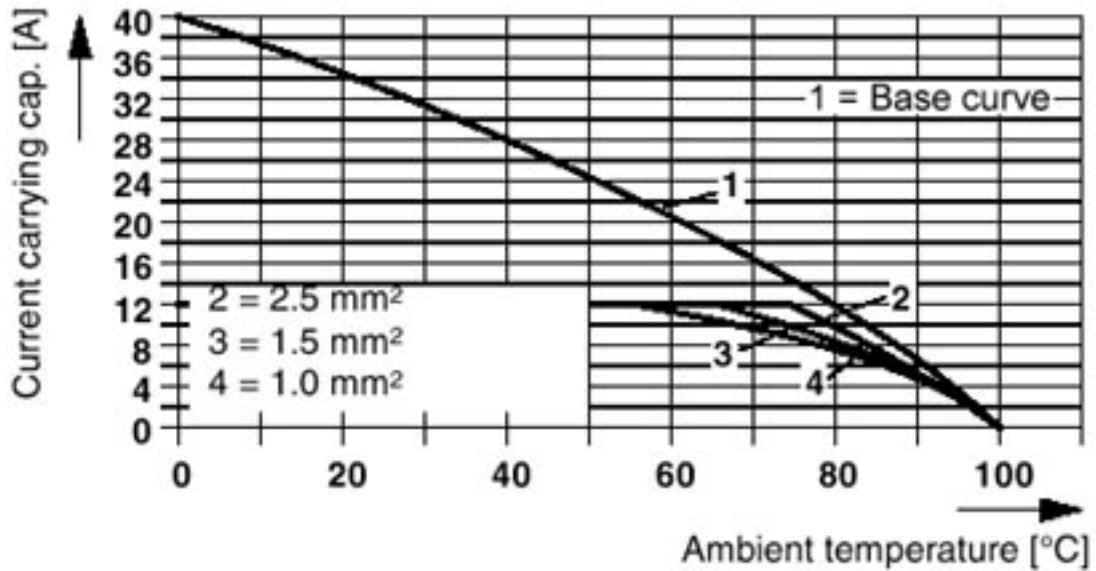

Diagram

Plug: FRONT-MSTB 2,5/5-ST(F)-(-5,08)  
Header: MSTB(A) 2,5/5-G(F)-(-5,08)

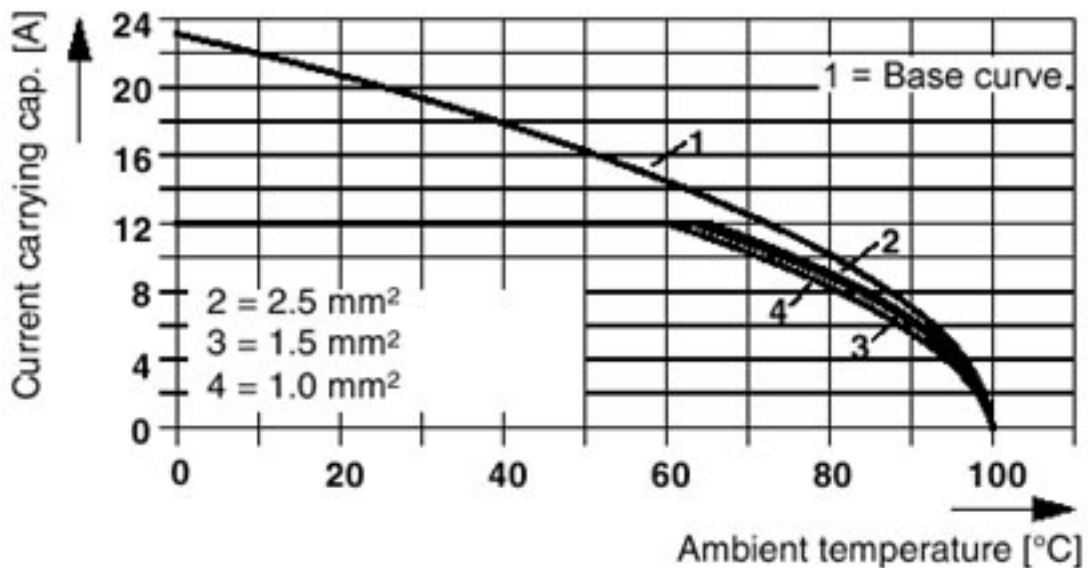

### Base strip - MSTBA 2,5/12-G-5,08 - 1757349

Diagram

Plug: TMSTBP 2,5/5-ST(F)-(5,08)  
Header: MSTB(A) 2,5/5-G(F)-(5,08)

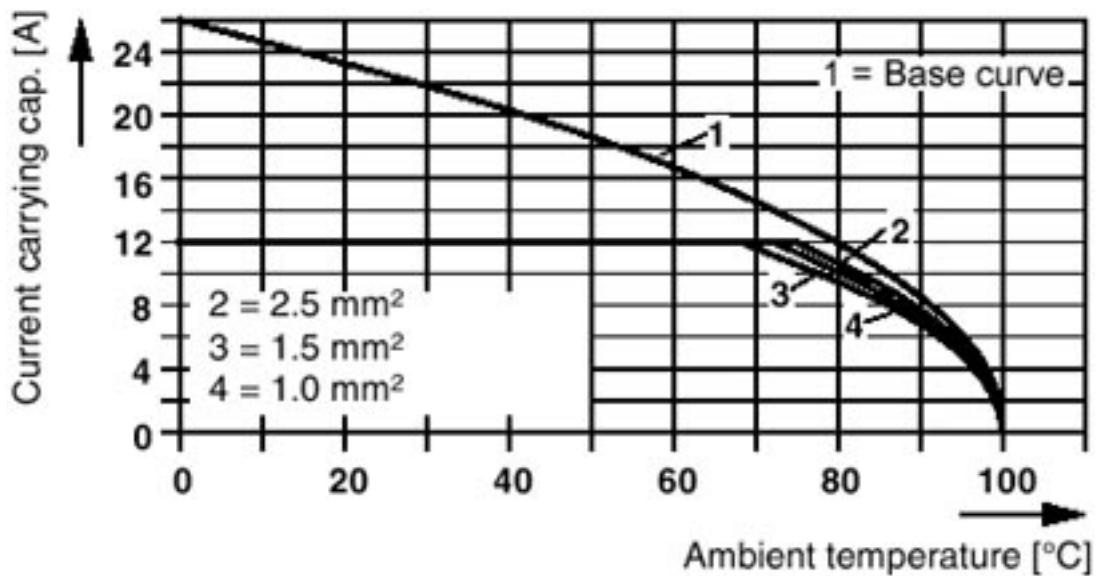

Diagram

Plug: FKC 2,5/5-ST(F)-5,08  
Header: MSTB(A) 2,5/5-G(F)-5,08

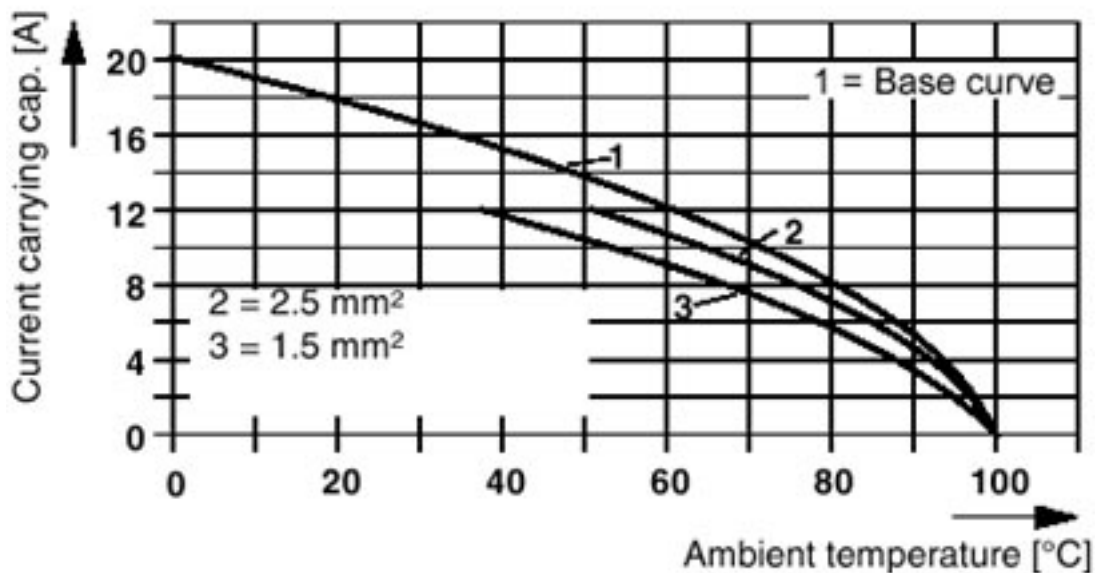

### Base strip - MSTBA 2,5/12-G-5,08 - 1757349

Diagram

Plug: FKCVR(W) 2,5/5-ST(F)-5,08  
 Header: MSTB(A) 2,5/5-G(F)-5,08

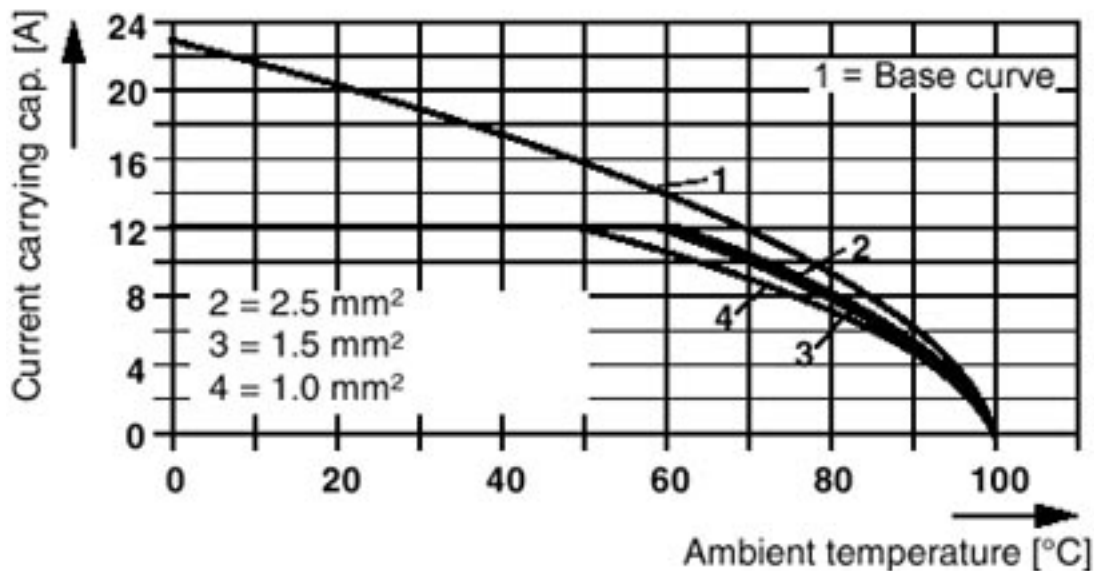

Diagram

Plug: MSTB 2,5/5-ST(F)(-5,08)  
 Header: MSTBO 2,5/5-GR(L)(-5,08)

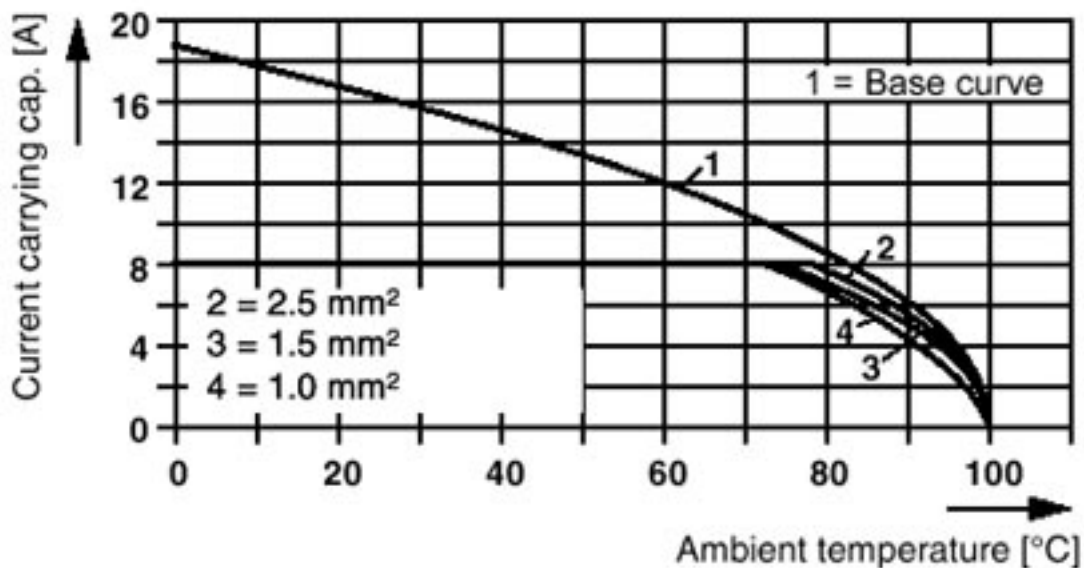



## Base strip - MSTBA 2,5/12-G-5,08 - 1757349

Diagram

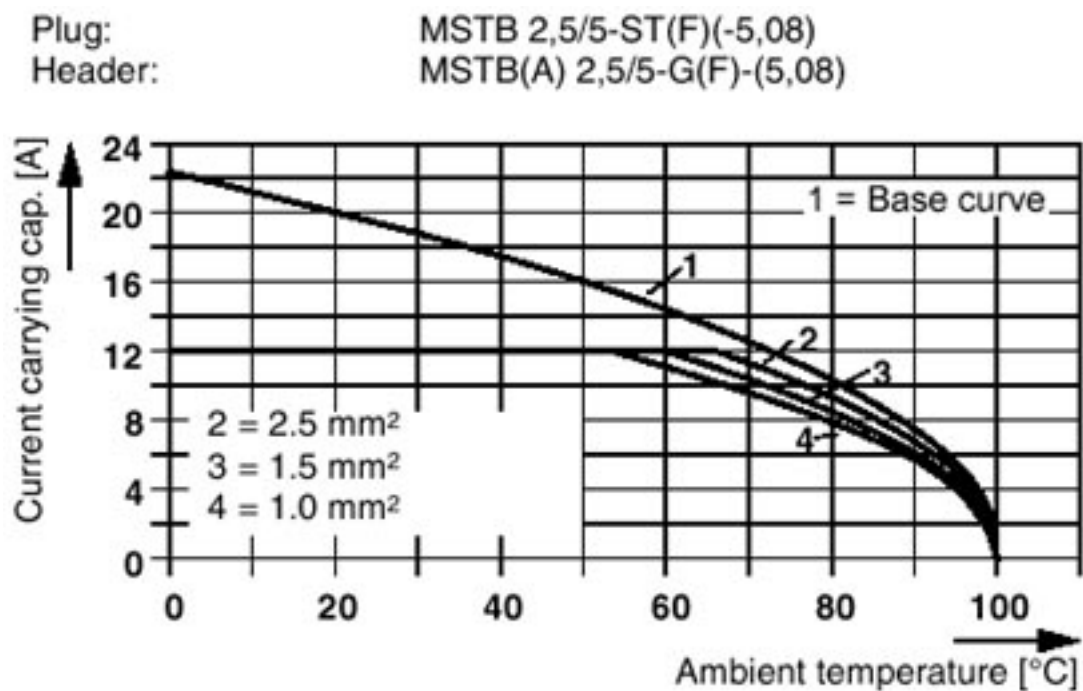

### Classifications

eCl@ss

eCl@ss 4.0	272607xx
eCl@ss 4.1	27260701
eCl@ss 5.0	27260701
eCl@ss 5.1	27260701
eCl@ss 6.0	27260704
eCl@ss 7.0	27440402
eCl@ss 8.0	27440402
eCl@ss 9.0	27440402

ETIM

ETIM 3.0	EC001121
ETIM 4.0	EC002637
ETIM 5.0	EC002637
ETIM 6.0	EC002637

UNSPSC

UNSPSC 6.01	30211810
UNSPSC 7.0901	39121409
UNSPSC 11	39121409
UNSPSC 12.01	39121409
UNSPSC 13.2	39121409



# Base strip - MSTBA 2,5/12-G-5,08 - 1757349

## Approvals

### Approvals

#### Approvals

CSA / VDE Gutachten mit Fertigungsüberwachung / IECEE CB Scheme / cULus Recognized / EAC

#### Ex Approvals

### Approval details

CSA		<a href="http://www.csagroup.org/services/testing-and-certification/certified-product-listing/">http://www.csagroup.org/services/testing-and-certification/certified-product-listing/</a>	13631
		B	D
Nominal current IN		15 A	10 A
Nominal voltage UN		300 V	300 V

VDE Gutachten mit Fertigungsüberwachung		<a href="http://www.vde.com/en/Institute/OnlineService/VDE-approved-products/Pages/Online-Search.aspx">http://www.vde.com/en/Institute/OnlineService/VDE-approved-products/Pages/Online-Search.aspx</a>	40004701
Nominal current IN		12 A	
Nominal voltage UN		250 V	

IECEE CB Scheme		<a href="http://www.iecee.org/">http://www.iecee.org/</a>	DE1-56062-B1B2
Nominal current IN		12 A	
Nominal voltage UN		250 V	

cULus Recognized		<a href="http://database.ul.com/cgi-bin/XYV/template/LISEXT/1FRAME/index.htm">http://database.ul.com/cgi-bin/XYV/template/LISEXT/1FRAME/index.htm</a>	E60425-19931011
		B	D
Nominal current IN		15 A	10 A
Nominal voltage UN		300 V	300 V

EAC			B.01742
-----	--	--	---------

## Base strip - MSTBA 2,5/12-G-5,08 - 1757349

### Accessories

Accessories

Coding element

Coding star - CR-MSTB - 1734401



Coding section, inserted into the recess in the header or the inverted plug, red insulating material

---

### Filler plug

Accessories - MSTB-BL - 1755477



Keying cap, for forming sections, plugs onto header pin, green insulating material

---

### Labeled terminal marker

Marker card - SK 5,08/3,8:FORTL.ZAHLEN - 0804293



Marker card, Card, white, labeled, Horizontal: Consecutive numbers 1 - 10, 11 - 20, etc. up to 91 - (99)100, Mounting type: Adhesive, for terminal block width: 5.08 mm, Lettering field: 5.08 x 3.8 mm

---

### Marker pen

Marker pen - B-STIFT - 1051993



Marker pen, for manual labeling of unprinted Zack strips, smear-proof and waterproof, line thickness 0.5 mm

---

### Terminal marking

## Base strip - MSTBA 2,5/12-G-5,08 - 1757349

### Accessories

Marker card - SK 5,08/3,8:UNBEDRUCKT - 0805412



Marker card, Card, white, unlabeled, can be labeled with: Marker pen, Mounting type: Adhesive, for terminal block width: 5.08 mm, Lettering field: 5.08 x 3.8 mm

---

### Additional products

Printed-circuit board connector - FKCN 2,5/12-ST-5,08 - 1754665



Plug component, Nominal current: 12 A, Rated voltage (III/2): 320 V, Number of positions: 12, Pitch: 5.08 mm, Connection method: Push-in spring connection, Color: green, Contact surface: Tin

---

Printed-circuit board connector - MSTB 2,5/12-ST-5,08 - 1757116



Plug component, Nominal current: 12 A, Rated voltage (III/2): 320 V, Number of positions: 12, Pitch: 5.08 mm, Connection method: Screw connection with tension sleeve, Color: green, Contact surface: Tin

---

Printed-circuit board connector - MSTB 2,5/12-STZ-5,08 - 1764280



Plug component, Nominal current: 12 A, Rated voltage (III/2): 320 V, Number of positions: 12, Pitch: 5.08 mm, Connection method: Screw connection with tension sleeve, Color: green, Contact surface: Tin

---

Printed-circuit board connector - MSTBP 2,5/12-ST-5,08 - 1769117



Plug component, Nominal current: 12 A, Rated voltage (III/2): 320 V, Number of positions: 12, Pitch: 5.08 mm, Connection method: Screw connection with tension sleeve, Color: green, Contact surface: Tin

## Base strip - MSTBA 2,5/12-G-5,08 - 1757349

### Accessories

#### Printed-circuit board connector - FRONT-MSTB 2,5/12-ST-5,08 - 1777387

Plug component, Nominal current: 12 A, Rated voltage (III/2): 320 V, Number of positions: 12, Pitch: 5.08 mm, Connection method: Front screw connection, Color: green, Contact surface: Tin



#### Printed-circuit board connector - MSTBT 2,5/12-ST-5,08 - 1781085

Plug component, Nominal current: 12 A, Rated voltage (III/2): 320 V, Number of positions: 12, Pitch: 5.08 mm, Connection method: Screw connection with tension sleeve, Color: green, Contact surface: Tin



#### Printed-circuit board connector - MVSTBR 2,5/12-ST-5,08 - 1792346

Plug component, Nominal current: 12 A, Rated voltage (III/2): 320 V, Number of positions: 12, Pitch: 5.08 mm, Connection method: Screw connection with tension sleeve, Color: green, Contact surface: Tin



#### Printed-circuit board connector - MVSTBW 2,5/12-ST-5,08 - 1792854

Plug component, Nominal current: 12 A, Rated voltage (III/2): 320 V, Number of positions: 12, Pitch: 5.08 mm, Connection method: Screw connection with tension sleeve, Color: green, Contact surface: Tin



#### Printed-circuit board connector - MSTBC 2,5/12-ST-5,08 - 1808913

Plug component, Nominal current: 12 A, Rated voltage (III/2): 320 V, Number of positions: 12, Pitch: 5.08 mm, Connection method: Crimp connection, Color: green, Corresponding female crimp contacts with current [A] and conductor cross section range [mm<sup>2</sup>] data: 10A/MSTBC-MT 0,5-1,0 (3190564); 10A/MSTBC-MT 0,5-1,0 BA (3190645); 12A/MSTBC-MT 1,5-2,5 (3190551); 12A/MSTBC-MT 1,5-2,5 BA (3190658). BA = Bandkontakte



## Base strip - MSTBA 2,5/12-G-5,08 - 1757349

### Accessories

#### Printed-circuit board connector - MSTBC 2,5/12-STZ-5,08 - 1809608



Plug component, Nominal current: 12 A, Rated voltage (III/2): 320 V, Number of positions: 12, Pitch: 5.08 mm, Connection method: Crimp connection, Color: green, Corresponding female crimp contacts with current [A] and conductor cross section range [mm<sup>2</sup>] data: 10A/MSTBC-MT 0,5-1,0 (3190564); 10A/MSTBC-MT 0,5-1,0 BA (3190645); 12A/MSTBC-MT 1,5-2,5 (3190551); 12A/MSTBC-MT 1,5-2,5 BA (3190658). BA = Bandkontakte

#### Printed-circuit board connector - MSTBU 2,5/12-STD-5,08 - 1824227



Plug component, Nominal current: 12 A, Rated voltage (III/2): 320 V, Number of positions: 12, Pitch: 5.08 mm, Connection method: Screw connection with tension sleeve, Color: green, Contact surface: Tin, Mounting: Direct mounting

#### Printed-circuit board connector - MSTBU 2,5/12-ST-5,08-FL - 1824450



Plug component, Nominal current: 12 A, Rated voltage (III/2): 320 V, Number of positions: 12, Pitch: 5.08 mm, Connection method: Screw connection with tension sleeve, Color: green, Contact surface: Tin, Mounting: Direct mounting

#### Printed-circuit board connector - SMSTB 2,5/12-ST-5,08 - 1826380



Plug component, Nominal current: 12 A, Rated voltage (III/2): 320 V, Number of positions: 12, Pitch: 5.08 mm, Connection method: Screw connection with tension sleeve, Color: green, Contact surface: Tin

#### Printed-circuit board connector - MSTBVK 2,5/12-ST-5,08 - 1831414



Plug component, Nominal current: 12 A, Rated voltage (III/2): 320 V, Number of positions: 12, Pitch: 5.08 mm, Connection method: Screw connection with tension sleeve, Color: green, Contact surface: Tin, Mounting: DIN rail

## Base strip - MSTBA 2,5/12-G-5,08 - 1757349

### Accessories

Printed-circuit board connector - UMSTBVK 2,5/12-ST-5,08 - 1833917



Plug component, Nominal current: 12 A, Rated voltage (III/2): 320 V, Number of positions: 12, Pitch: 5.08 mm, Connection method: Screw connection with tension sleeve, Color: green, Contact surface: Tin, Mounting: DIN rail

Printed-circuit board connector - FKC 2,5/12-ST-5,08 - 1873155



Plug component, Nominal current: 12 A, Rated voltage (III/2): 320 V, Number of positions: 12, Pitch: 5.08 mm, Connection method: Push-in spring connection, Color: green, Contact surface: Tin

Printed-circuit board connector - FKCVW 2,5/12-ST-5,08 - 1873757



Plug component, Nominal current: 12 A, Rated voltage (III/2): 320 V, Number of positions: 12, Pitch: 5.08 mm, Connection method: Push-in spring connection, Color: green, Contact surface: Tin

Printed-circuit board connector - FKCVR 2,5/12-ST-5,08 - 1874057



Plug component, Nominal current: 12 A, Rated voltage (III/2): 320 V, Number of positions: 12, Pitch: 5.08 mm, Connection method: Push-in spring connection, Color: green, Contact surface: Tin

Printed-circuit board connector - QC 1/12-ST-5,08 - 1883705



Plug component, Nominal current: 10 A, Rated voltage (III/2): 630 V, Number of positions: 12, Pitch: 5.08 mm, Connection method: Displacement connection, Color: green, Contact surface: Tin

## Base strip - MSTBA 2,5/12-G-5,08 - 1757349

### Accessories

Printed-circuit board connector - FKCT 2,5/12-ST-5,08 - 1902217



Plug component, Nominal current: 12 A, Rated voltage (III/2): 320 V, Number of positions: 12, Pitch: 5.08 mm, Connection method: Push-in spring connection, Color: green, Contact surface: Tin

---

Printed-circuit board connector - FKCS 2,5/12-ST-5,08 - 1975176



Plug component, Nominal current: 12 A, Rated voltage (III/2): 320 V, Number of positions: 12, Pitch: 5.08 mm, Connection method: Push-in spring connection, Color: green, Contact surface: Tin