

FKS ATO[®] STYLE BLADE FUSE RATED 80V

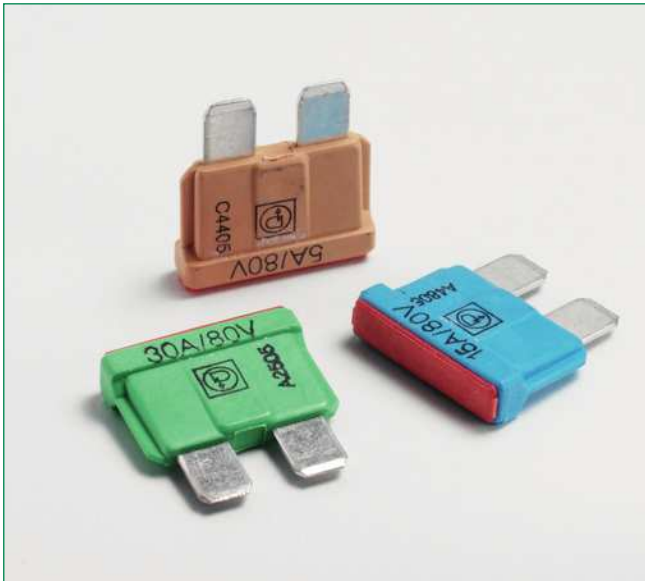

Description

The FKS-80 is an ATO[®] style blade fuse rated at 80V, featuring a three part construction with copper contacts for excellent reliability in harsh environment conditions and low voltage drop. Current ratings 3A thru 30A. Filled with arc-quenching material.

Specifications

| | |
|----------------------|---|
| cULus Recognized: | File No. E10480 |
| Interrupting Rating: | 1000 A @ 80 VDC |
| Insulating body: | Out of thermoplastic (UL 94-V0, heat-resistant) |
| Cover: | Out of thermoplastic (UL 94-V0, heat-resistant) Red, not transparent |
| Terminals: | Blade contacts Copper alloy, gal. Sn plated Edge-protected |
| Complies with: | UL 248 Supplemental Fuses |









Ordering Information

| Part Number | Package Size |
|---------------|--------------|
| 166.7000.xxx6 | 100 |
| 166.7000.xxx2 | 500 |

Time-Current Characteristics

| % of Rating | Opening Time Min / Max (s) |
|-------------|----------------------------|
| 110 | 360,000 s / - |
| 135 | 0.500 s / 300 s |
| 200 | 0.150 s / 20 s |
| 350 | 0.040 s / 0.500 s |
| 600 | 0.020 s / 0.100 s |

Ratings

| Part Number | Current Rating | Housing Color | Typ. Voltage Drop | Cold Resistance | I ² t |
|---------------|----------------|---|-------------------|-----------------|------------------------|
| 166.7000.430_ | 3 A |  | 145 mV | 39.0 mΩ | 8.10 A ² s |
| 166.7000.440_ | 4 A |  | 140 mV | 29.0 mΩ | 14.4 A ² s |
| 166.7000.450_ | 5 A |  | 140 mV | 20.6 mΩ | 24.3 A ² s |
| 166.7000.475_ | 7.5 A |  | 120 mV | 11.5 mΩ | 44.5 A ² s |
| 166.7000.510_ | 10 A |  | 110 mV | 7.90 mΩ | 86.4 A ² s |
| 166.7000.515_ | 15 A |  | 110 mV | 4.60 mΩ | 162 A ² s |
| 166.7000.520_ | 20 A |  | 110 mV | 3.30 mΩ | 475 A ² s |
| 166.7000.525_ | 25 A |  | 105 mV | 2.27 mΩ | 950 A ² s |
| 166.7000.530_ | 30 A |  | 100 mV | 1.79 mΩ | 1,500 A ² s |

Corresponding holder see Section "Fuse Holders."

FKS ATO® STYLE BLADE FUSE RATED 80V



Dimensions

Dimensions in mm

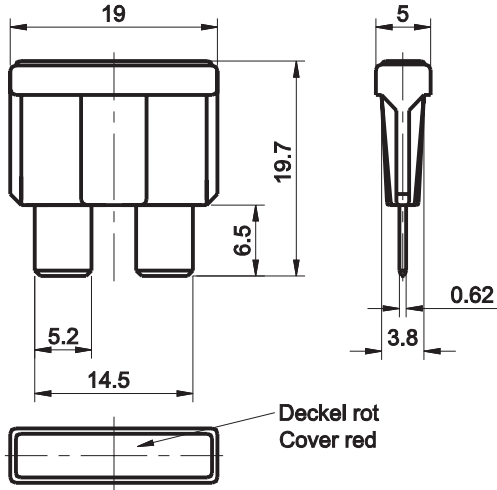

Pre-arcing Time-limits

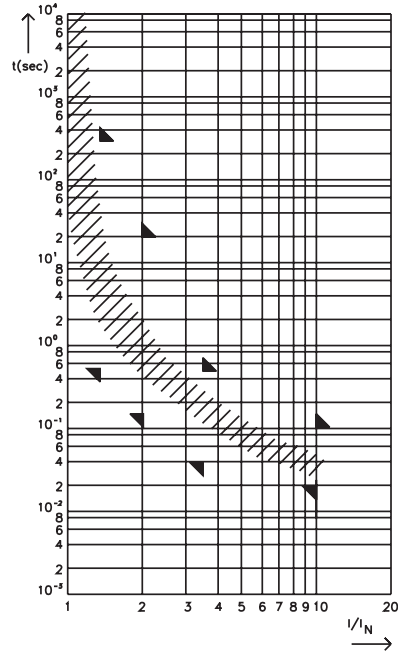

FI = 1.43 (max. operating current: $0.7 \times I_{rat}$ at 23°C)