

# General Specifications

## Electrical Capacity (Resistive Load)

<b>Power Level (silver):</b>	3A @ 125V AC & 2A @ 250V AC or 2A @ 30V DC
<b>Logic Level (gold):</b>	0.4VA maximum @ 28V AC/DC maximum (Applicable Range 0.1mA ~ 0.1A @ 20mV ~ 28V)

## Other Ratings

<b>Contact Resistance:</b>	10 milliohms maximum for silver; 20 milliohms maximum for gold
<b>Insulation Resistance:</b>	1,000 megohms minimum @ 500V DC
<b>Dielectric Strength:</b>	1,000V AC minimum between contacts for 1 minute minimum; 1,500V AC minimum between contacts & case for 1 minute minimum
<b>Mechanical Life:</b>	50,000 operations minimum
<b>Electrical Life:</b>	25,000 operations minimum for silver; 50,000 operations minimum for gold

**Nominal Operating Force:** Momentary Action: 1-pole 9.32N; 2-pole 16.18N; 4-pole 25.54N;  
Alternate Action: 1-pole 4.41N; 2-pole 7.06N; 4-pole 11.77N

<b>Contact Timing:</b>	Slow make, slow break		
<b>Plunger Travel:</b>	Screw-on Cap (Mom.)	Screw-on Cap (Alt.)	Snap-on Cap (Mom. & Alt.)
<b>Pretravel:</b>	.028" (0.71mm)	.110" (2.80mm)	.125" (3.19mm)
<b>Overtravel:</b>	.043" (1.09mm)	.043" (1.09mm)	.050" (1.26mm)
<b>Total Travel</b>	.071" (1.80mm)	.153" (3.90mm)	.175" (4.45mm)

## Materials & Finishes

<b>Plunger:</b>	Brass w/nickel plating; polyacetal w/B1 bushing
<b>Bushing:</b>	Brass with nickel plating
<b>Frame:</b>	Stainless steel
<b>Case:</b>	Diallyl phthalate resin (UL94V-0)
<b>Movable Contactor:</b>	Phosphor bronze with silver or gold plating
<b>Movable Contacts:</b>	Silver alloy (code W); copper with gold plating (code G)
<b>Stationary Contacts:</b>	Silver with silver plating (code W); copper or brass with gold plating (code G)
<b>Terminals:</b>	Copper or brass with silver plating; copper or brass with gold plating

## Environmental Data

<b>Operating Temp Range:</b>	-30°C through +85°C (-22°F through +185°F)
<b>Humidity:</b>	90 ~ 95% humidity for 96 hours @ 40°C (104°F)
<b>Vibration:</b>	10 ~ 55Hz with peak-to-peak amplitude of 1.5mm traversing the frequency range & returning in 1 minute; 3 right angled directions for 2 hours
<b>Shock:</b>	50G (490m/s <sup>2</sup> ) acceleration (tested in 6 right angled directions, with 5 shocks in each direction)
<b>Sealing:</b>	B3 & D3 bushing options equivalent to IP67

## Installation

<b>Mounting Torque:</b>	1.5Nm (13.0 lb•in) for double nut; 0.7Nm (6.0 lb•in) for single nut
<b>Cap Installation Force:</b>	80.0N (18.0 lbf) maximum downward force on actuator
<b>Soldering Time &amp; Temp:</b>	Wave Soldering (PC version): See Profile A in Supplement section. Manual Soldering: See Profile A in Supplement section.
<b>Process Seal:</b>	These devices are not process sealed. Hand clean locally using alcohol based solution.

## Standards & Certifications

<b>Flammability Standards:</b>	UL94V-0 case
<b>UL:</b>	Contact NKK Switches for UL or CUL marking option requirements.

# Distinctive Characteristics

Guide interlocked with actuator block prevents window locking and maintains correct plunger alignment to assure contact stability.

Employs an over-center actuator mechanism, which diminishes sparking and increases operating life in AC circuits.

High torque bushing construction prevents rotation or separation from frame during installation.

Splashproof option (D3 and B3 bushing codes) features an o-ring within the bushing and one under the face nut to protect from splashed, sprayed, or spilled liquids. Splashproof models meet IP67 of IEC 60529 Standards at front panel (dust tight and water protected from effects of temporary immersion).

High insulating barriers, formed in the molded diallyl phthalate case, increase isolation of circuits in multipole devices.

Prominent external insulating barriers increase insulation resistance and dielectric strength.

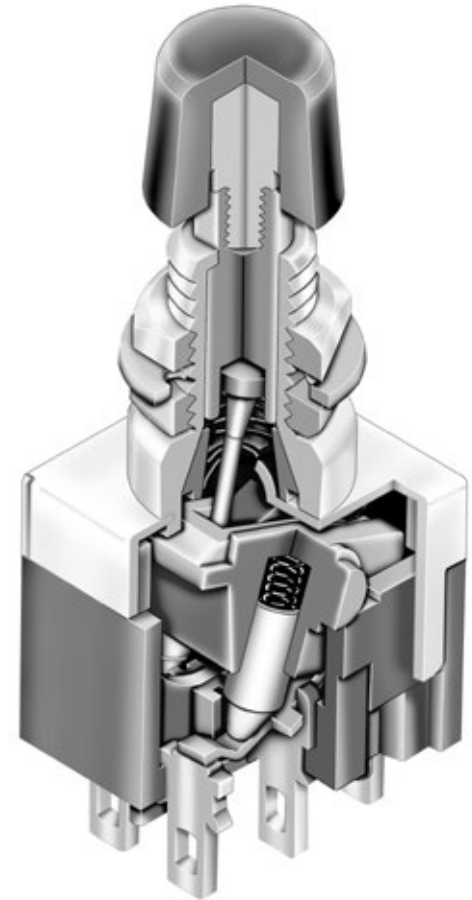

Epoxy sealed terminals prevent entry of solder flux and other contaminants.

Clinching of the frame to the case well above the base and terminals provides 1,500V dielectric strength.



Actual Size



	Bushing Mount	Page C74
	Bracket PC Mount	Page C80
	Large Bushing	Page C85

- Toggle
- Rockers
- Pushbuttons**
- Illuminated PB
- Programmable
- Keylocks
- Rotaries
- Slides
- Tactiles
- Tilt
- Touch
- Indicators
- Accessories
- Supplement

### TYPICAL SWITCH ORDERING EXAMPLE

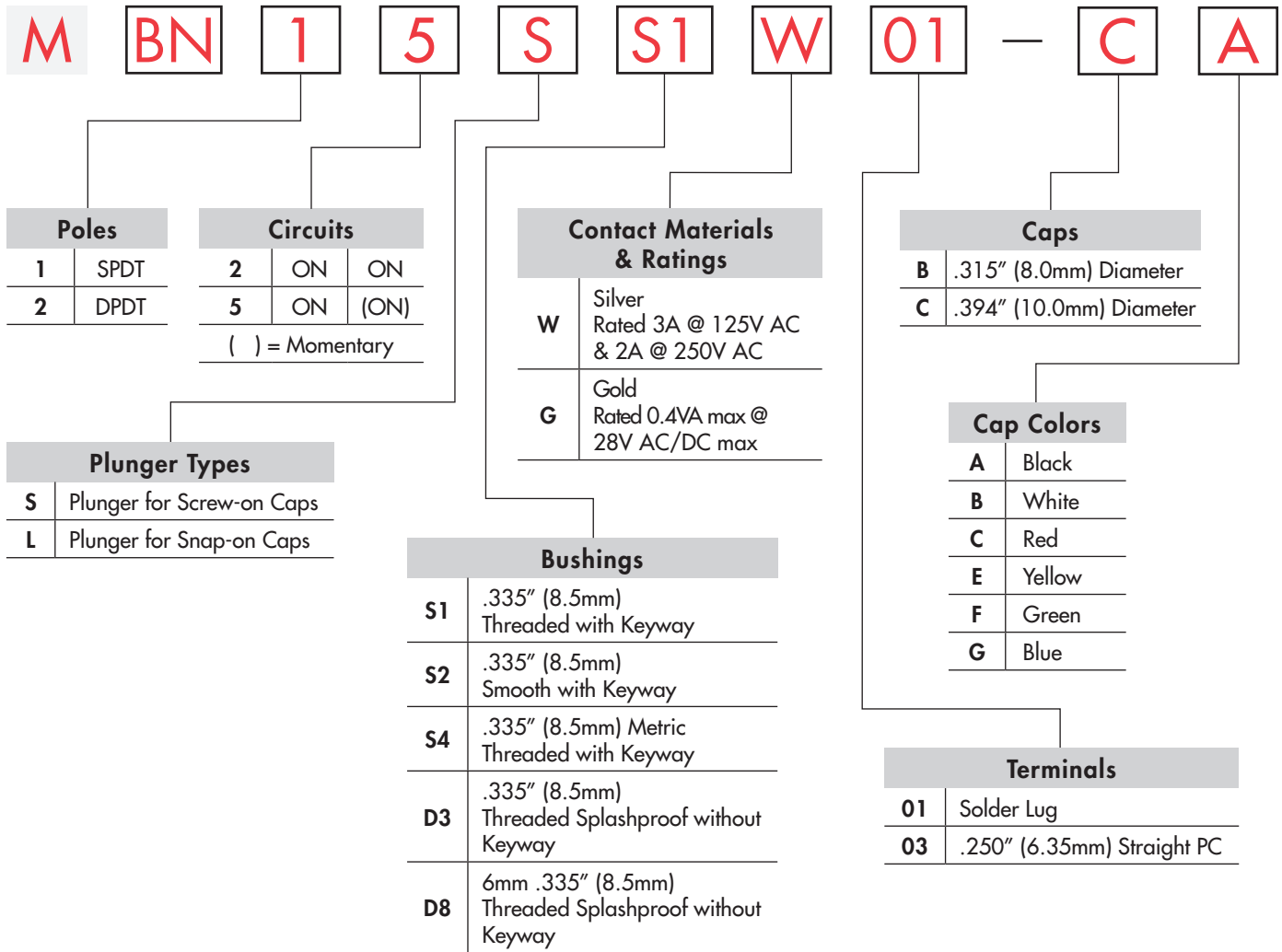



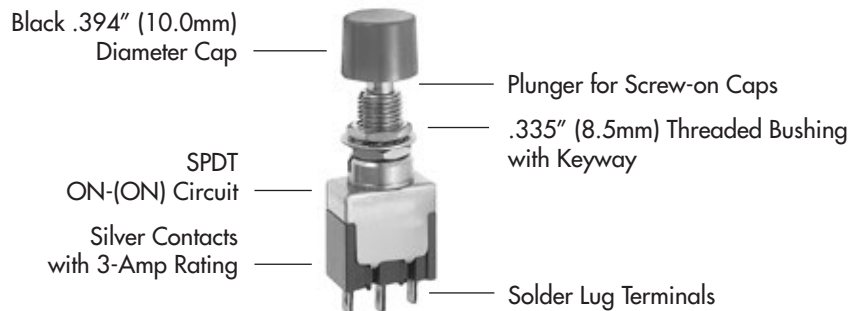

### DESCRIPTION FOR TYPICAL ORDERING EXAMPLE

#### MBN15SS1W01-CA



Toggles  
Rockers  
Pushbuttons  
Illuminated PB  
Programmable  
Keylocks  
Rotaries  
Slides  
Tactiles  
Tilt  
Touch  
Indicators  
Accessories  
Supplement

## POLES & CIRCUITS

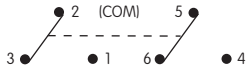
Pole	Model	Plunger Position ( ) = Momentary		Connected Terminals		Throw & Switch Schematics
		Normal 	Down 	Normal 	Down 	
SP	MBN12	ON	ON	2-3	2-1	SPDT 
	MBN15	ON	(ON)			
DP	MBN22	ON	ON	2-3 5-6	2-1 5-4	DPDT 
	MBN25	ON	(ON)			

## PLUNGER TYPES

On alternate action models, after transferring circuit, the plunger returns to its original position and does not latch down.

**S**

### Plunger for Screw-on Caps



Momentary  
Plunger Length

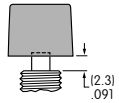

Momentary  
Cap Location



Alternate  
Plunger Length

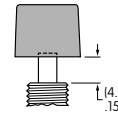

Alternate  
Cap Location

**L**

### Plunger for Snap-on Caps

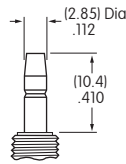

Momentary & Alternate  
Plunger Length

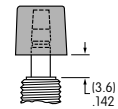

Momentary & Alternate  
Cap Location

## BUSHINGS

**S1**

### .335" (8.5mm) Threaded with Keyway

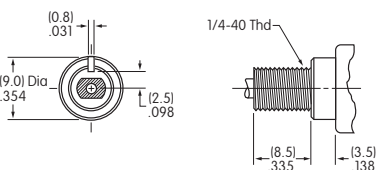

Maximum Panel Thickness with  
Standard Hardware: .154" (3.9mm)

**S2**

### .335" (8.5mm) Smooth with Keyway

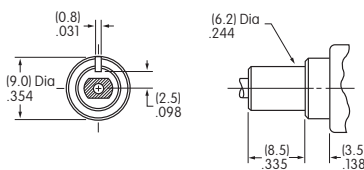

**S4**

### .335" (8.5mm) Metric Threaded with Keyway

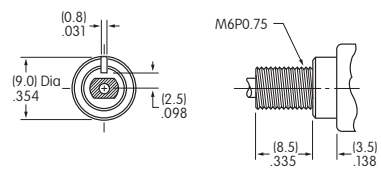

Maximum Panel Thickness with  
Standard Hardware: .154" (3.9mm)

Toggles  
Rockers  
Pushbuttons  
Illuminated PB  
Programmable  
Keylocks  
Rotaries  
Slides  
Tactiles  
Tilt  
Touch  
Indicators  
Accessories  
Supplement

## BUSHINGS

**D3** .335" (8.5mm)  
Threaded Splashproof without Keyway

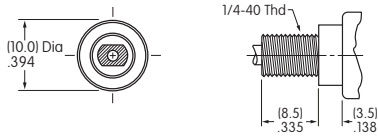

Maximum Panel Thickness with Standard Hardware: .240" (6.1mm)

**D8** .335" (8.5mm)  
Threaded Splashproof without Keyway

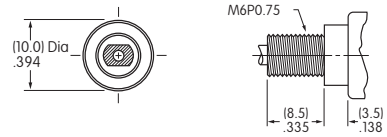

Maximum Panel Thickness with Standard Hardware: .240" (6.1mm)

### Panel Cutouts

For S1, S2 Bushing with Keyway

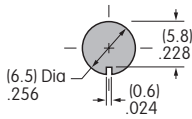

For S1 Bushing with Optional Locking Ring

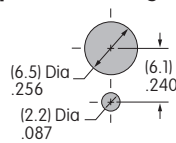

For S4 Bushing with Keyway

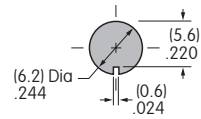

For S4 Bushing with Optional Locking Ring

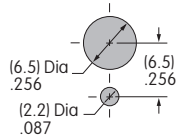

For D3 or D8 Bushing without Keyway

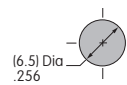

Standard hardware for bushings S1 & S4 includes 2 hex nuts & 1 lockwasher; D3 bushing has 1 hex nut & 1 o-ring. Standard & optional hardware are illustrated following the Typical Switch Dimension drawings.

## CONTACT MATERIALS & RATINGS

**W** Silver **Power Level** 3A @ 125V AC & 2A @ 250V AC

**G** Gold **Logic Level** 0.4VA maximum @ 28V AC/DC maximum

Note: Complete explanation of operating range in Supplement section.

**Gold over Silver** **Power Level or Logic Level** 3A @ 125V AC & 2A @ 250V AC or 0.4VA maximum @ 28V AC/DC maximum

Note: Gold over silver is available as a custom option. This dual rated option is suitable when two or more identical switches are used in logic and in power circuits within the same application. See Supplement section to find complete explanation of dual rating and operating range.

## TERMINALS

**01** Solder Lug

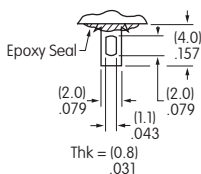

**03** .250" (6.35mm)  
Straight PC

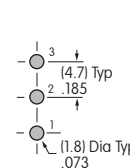
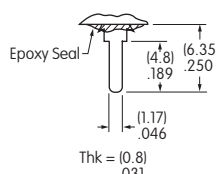

Single Pole

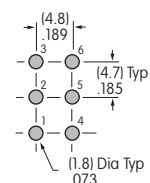

Double Pole

## CAPS & CAP COLORS

**B** **AT413**  
 .315" (8.0mm) Diameter  
 Screw-on Cap

**AT443**  
 .315" (8.0mm) Diameter  
 Snap-on Cap

**C** **AT407**  
 .394" (10.0mm) Diameter  
 Screw-on Cap

**AT442**  
 .394" (10.0mm) Diameter  
 Snap-on Cap

For use with Plunger Code S

For use with Plunger Code L

For use with Plunger Code S

For use with Plunger Code L

Cap Material: PBT  
 Finish: Glossy

Cap Material: Polycarbonate  
 Finish: Glossy

Cap Material: PBT  
 Finish: Glossy

Cap Material: Polycarbonate  
 Finish: Glossy

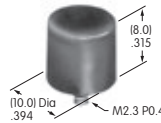
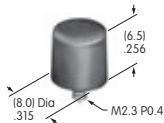

Cap Colors Available:

**A** Black

**B** White

**C** Red

**E** Yellow

**F** Green

**G** Blue

## TYPICAL SWITCH DIMENSIONS

### Single Pole

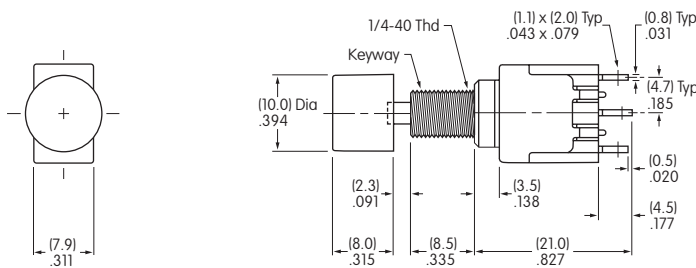

### Solder Lug

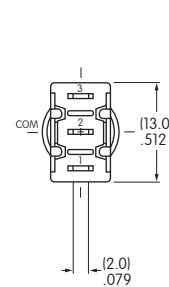

**MBN15SS1W01-CA**

### Double Pole

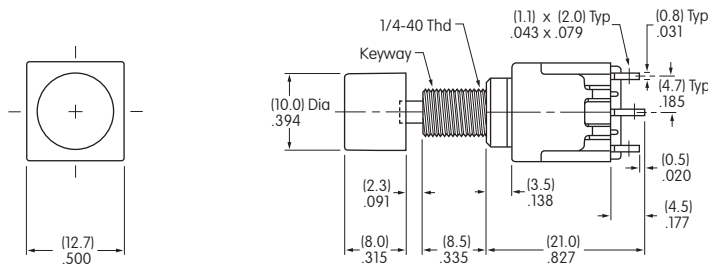

### Solder Lug

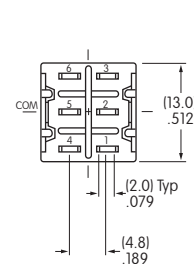

**MBN25SS1W01-CA**

### HARDWARE

#### Standard Hardware

##### AT513H for Inch AT513M for Metric Hexagon Nut

2 included with each switch  
(1 with splashproof models)

Material:  
Brass with  
Nickel plating

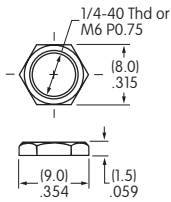

##### AT509 Lockwasher

1 included with each switch  
(not with splashproof models)

Material:  
Steel with  
Zinc/Chromate

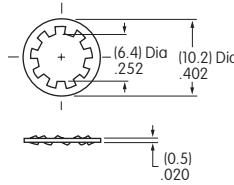

##### AT516 O-ring for Splashproof Bushing

1 included with each  
splashproof model

Material:  
Nitrile butadiene  
rubber

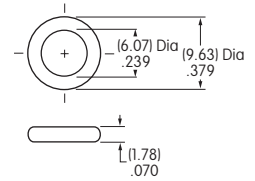

#### Optional Hardware

##### AT507M for Metric Locking Ring

Material:  
Steel with  
Zinc/Chromate

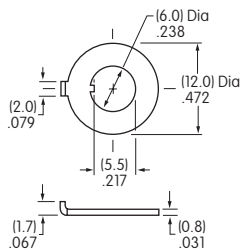

##### AT507H for Inch Locking Ring

Material:  
Steel with  
Zinc/Chromate

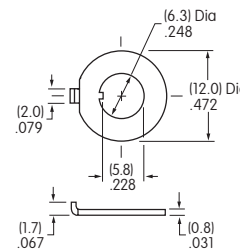

#### Optional Mounting Collars/Conical Nuts

##### AT512H for Inch AT512M for Metric Conical Nut

Used with .315" (8.0mm)  
Diameter Cap (cap code B)  
Material:  
Brass with  
chrome plating



##### AT512CH for Inch AT512CM for Metric Conical nut

Used with .394" (10.0mm)  
Diameter Cap (cap code C)  
Material:  
Brass with  
chrome plating



#### Optional Splashproof Boots for S Plunger

##### AT4041H for Inch AT4041M for Metric Boot for Momentary

Material:  
Silicone rubber



##### AT4042H for Inch AT4042M for Metric Boot for Alternate

Material:  
Silicone rubber

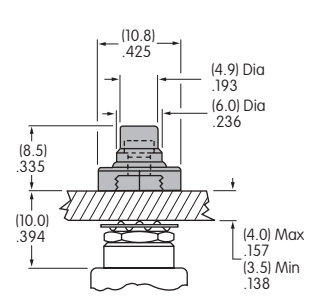
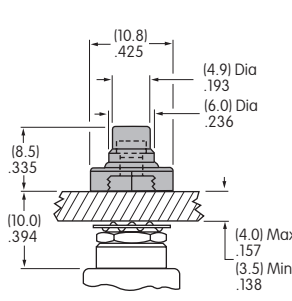
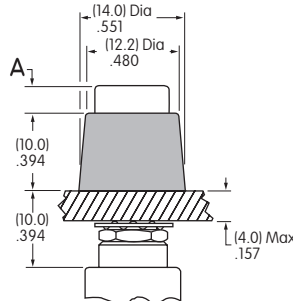
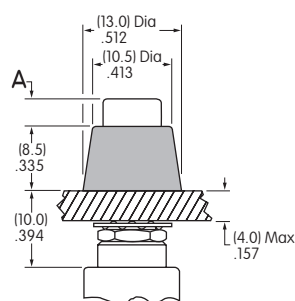

Dimension A = Cap Height

Operating Life 50,000

Operating Life 30,000

.091" (2.3mm) for Momentary with Plunger Code S  
.157" (4.0mm) for Alternate with Plunger Code S  
.142" (3.6mm) for Momentary & Alternate with Plunger Code L

Boots for momentary devices are accompanied by a threaded adaptor which extends the length of the plunger.

Optional Conical Nuts fit with all 8.5mm bushing options except the D3 & S2 bushings.





### TYPICAL SWITCH ORDERING EXAMPLE

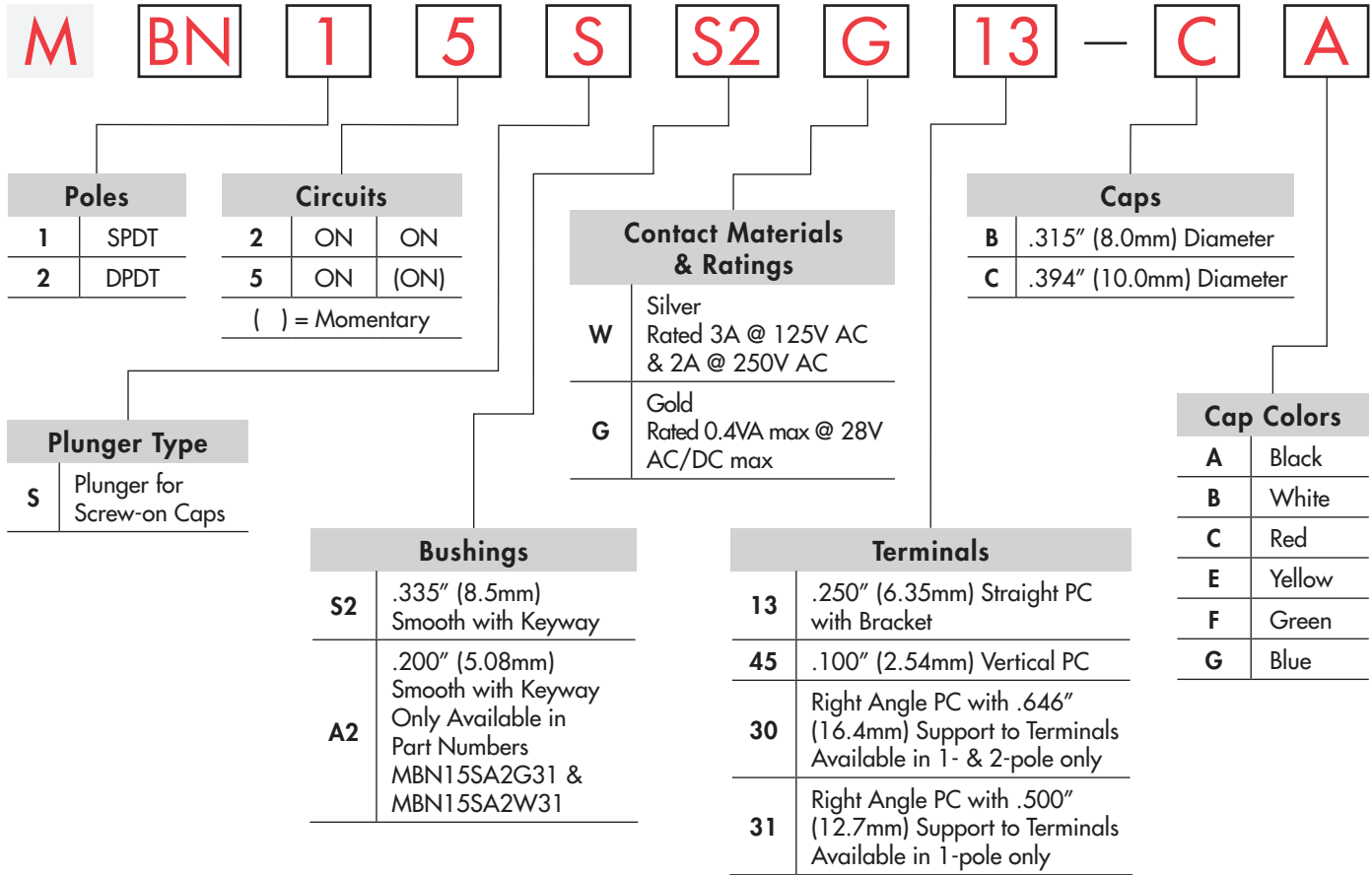

### DESCRIPTION FOR TYPICAL ORDERING EXAMPLE

#### MBN15SS2G13-CA

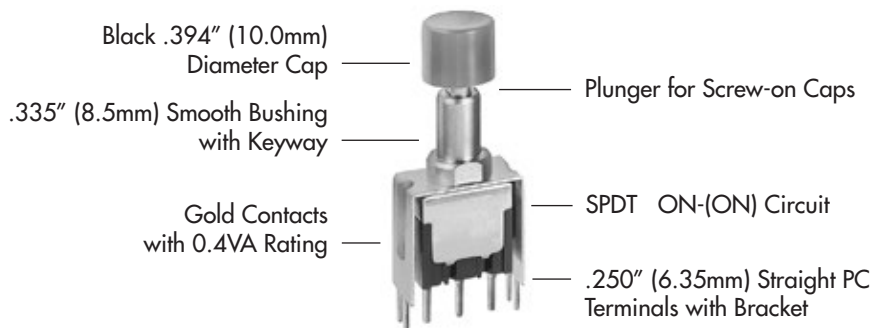

## POLES & CIRCUITS

Pole	Model	Plunger Position ( ) = Momentary		Connected Terminals		Throw & Switch Schematics
		Normal	Down	Normal	Down	
						Note: Terminal numbers are not actually on the switch.
SP	MBN12 MBN15	ON ON	ON (ON)	2-3	2-1	SPDT 
DP	MBN22 MBN25	ON ON	ON (ON)	2-3 5-6	2-1 5-4	DPDT 

## PLUNGER TYPE

On alternate action models, after transferring circuit, the plunger returns to its original position and does not latch down.

**S**

Plunger for Screw-on Caps

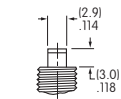

Momentary Plunger Length

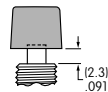

Momentary Cap Location



Alternate Plunger Length

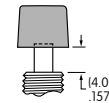

Alternate Cap Location

## BUSHINGS

**S2**

.335" (8.5mm)  
Smooth with Keyway

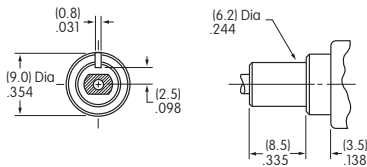

**A2**

.200" (5.08mm)  
Smooth with Keyway

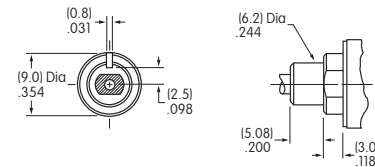

Only available in part numbers  
MBN15SA2W31 & MBN15SA2G31

## Panel Cutout

For S2 or A2 Bushing with Keyway

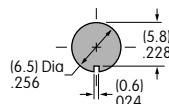

Toggles  
Rockers  
Pushbuttons  
Illuminated PB  
Programmable  
Keylocks  
Rotaries  
Slides  
Tactiles  
Tilt  
Touch  
Indicators  
Accessories  
Supplement

### CONTACT MATERIALS & RATINGS

**W** Silver Power Level 3A @ 125V AC & 2A @ 250V AC

**G** Gold Logic Level 0.4VA maximum @ 28V AC/DC maximum

Note: Complete explanation of operating range in Supplement section.

**Gold over Silver** Power Level or Logic Level 3A @ 125V AC & 2A @ 250V AC or 0.4VA maximum @ 28V AC/DC maximum

Note: Gold over silver is available as a custom option. This dual rated option is suitable when two or more identical switches are used in logic and in power circuits within the same application. See Supplement section to find complete explanation of dual rating and operating range.

### TERMINALS

**13** .250" (6.35mm) Straight PC with Bracket

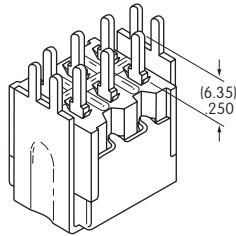

**45** .100" (2.54mm) Vertical PC

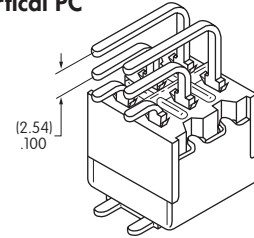

**30** Right Angle PC with .646" (16.4mm) Support to Terminal

Only Available in 1 & 2 Pole

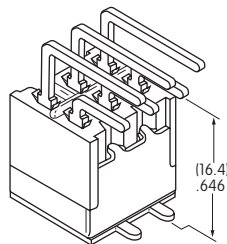

**31** Right Angle PC with .500" (12.7mm) Support to Terminal

Only Available in 1 Pole

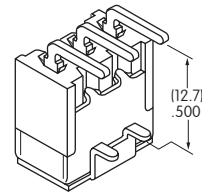

Note: Full dimensioned drawings appear on the following pages.

### CAPS & CAP COLORS

**B** AT413 .315" (8.0mm) Diameter Screw-on Cap

Cap Material: PBT  
Finish: Glossy



**C** AT407 .394" (10.0mm) Diameter Screw-on Cap

Cap Material: PBT  
Finish: Glossy

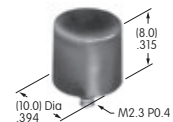

Cap Colors Available:

**A** Black **B** White **C** Red **E** Yellow **F** Green **G** Blue

## TYPICAL SWITCH DIMENSIONS

### Single Pole

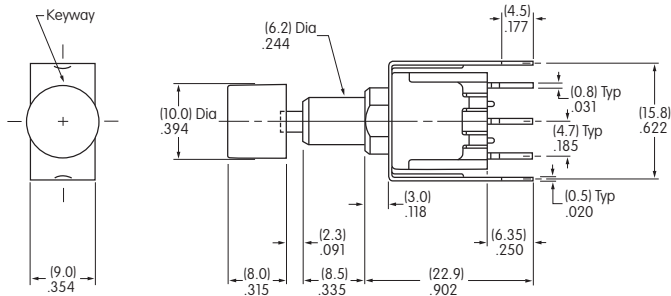

### Straight PC with Bracket

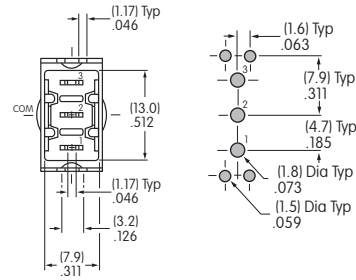

**MBN15SS2G13-CA**

### Double Pole

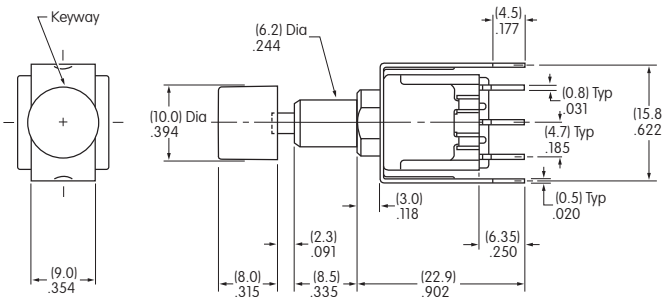

### Straight PC with Bracket

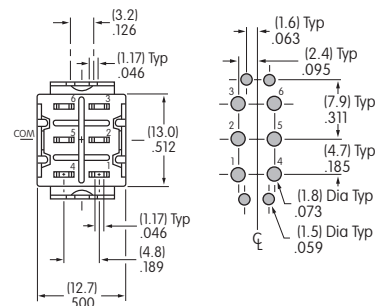

**MBN25SS2G13-CA**

### Single Pole

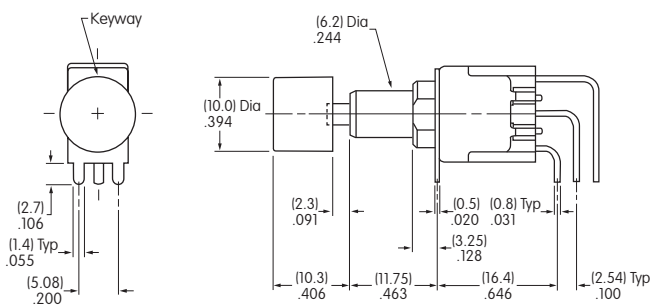

### .100" (2.54mm) Vertical PC

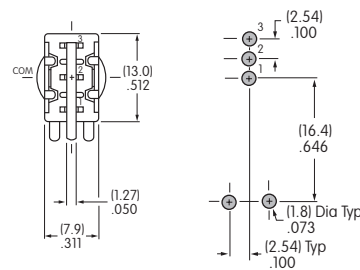

**MBN15SS2G45-CA**

## TYPICAL SWITCH DIMENSIONS

### .100" (2.54mm) Vertical PC

### Double Pole

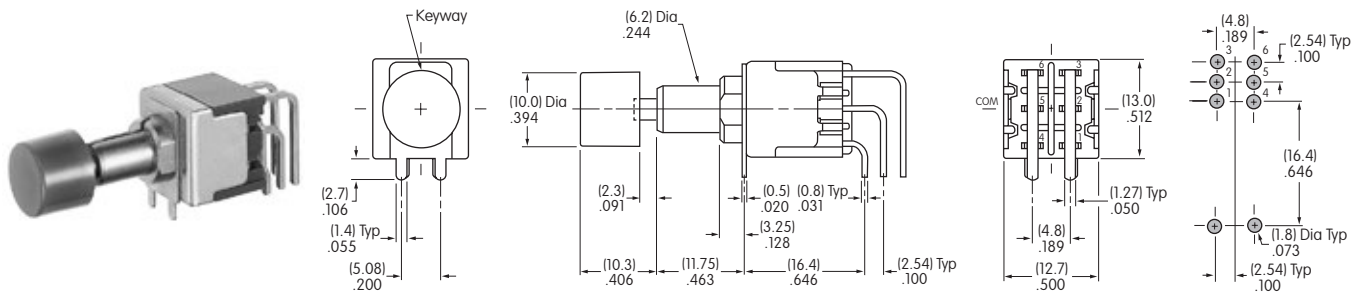

MBN25SS2G45-CA

### Right Angle PC

### Single Pole

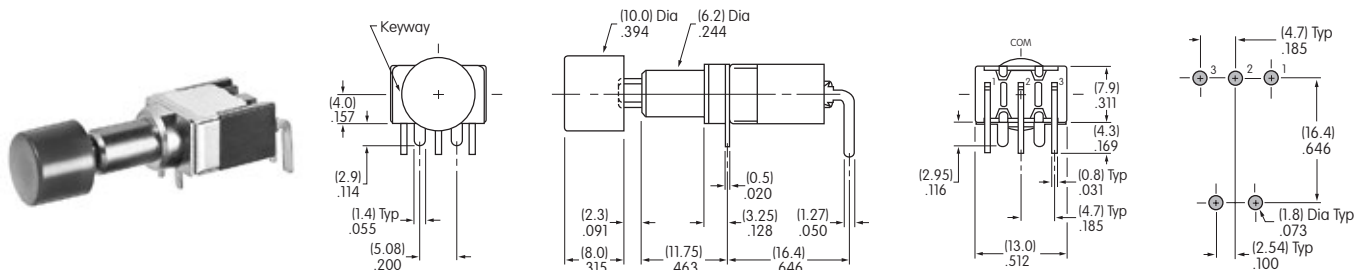

MBN12SS2G30-CA

### Right Angle PC

### Double Pole

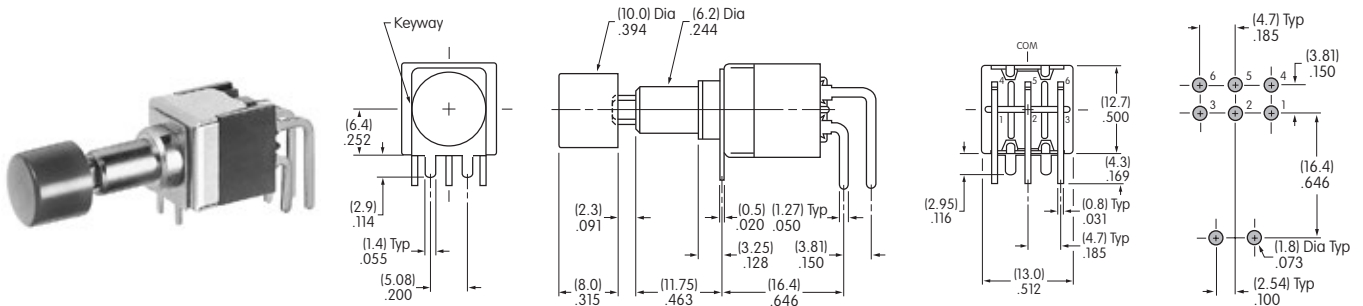

MBN22SS2G30-CA

### Right Angle PC with .500" (12.7mm) Support to Terminal

### Single Pole

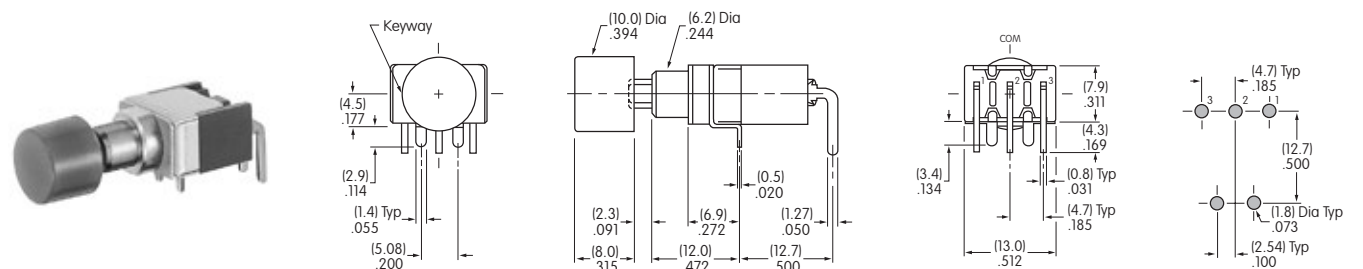

MBN15SA2G31-CA

## TYPICAL SWITCH ORDERING EXAMPLE

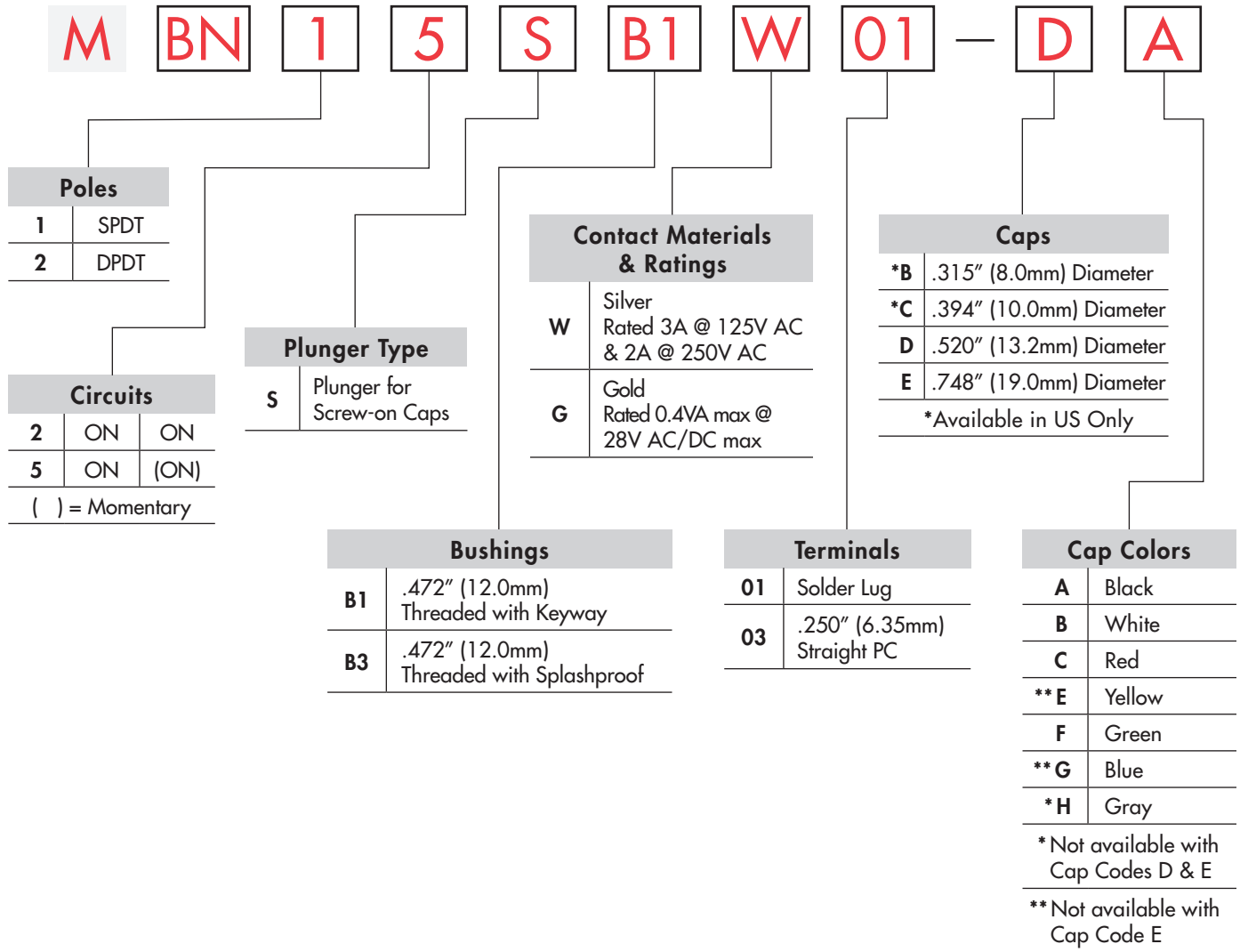

### DESCRIPTION FOR TYPICAL ORDERING EXAMPLE

**MBN15SB1W01-DA**

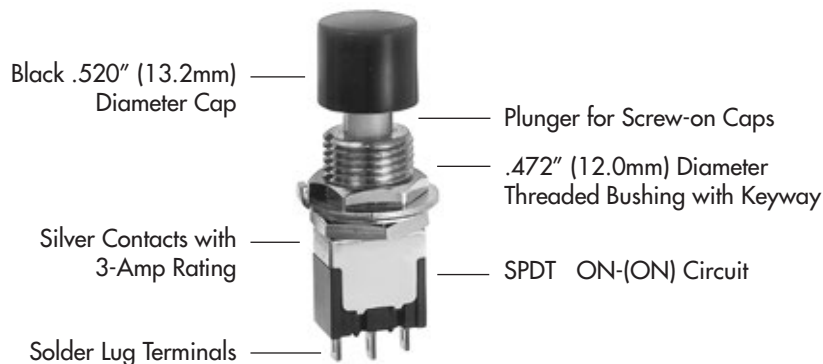

Toggles

Rockers

Pushbuttons

Programmable Illuminated PB

Keylocks

Rotaries

Slides

Tactiles

Tilt





Touch

Indicators

Accessories

Supplement

## POLES & CIRCUITS

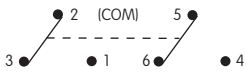
Pole	Model	Plunger Position ( ) = Momentary		Connected Terminals		Throw & Switch Schematics
		Normal 	Down 	Normal 	Down 	
SP	MBN12 MBN15	ON ON	ON (ON)	2-3	2-1	Note: Terminal numbers are not actually on the switch. 
DP	MBN22 MBN25	ON ON	ON (ON)	2-3 5-6	2-1 5-4	

## PLUNGER TYPE

**S**

**Plunger for Screw-on Caps**  
Plunger is plastic for B1 bushing.

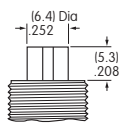

Plunger is metal for B3 bushing.

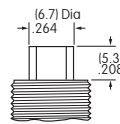

On alternate action models, after transferring circuit, the plunger returns to its original position, and does not latch down.

## BUSHINGS

**B1**

**.472" (12.0mm) Diameter Threaded with Keyway**

Maximum Panel Thickness with Standard Hardware: **.217" (5.5mm)**

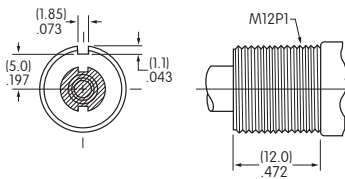
**B3**

**.472" (12.0mm) Diameter Threaded Splashproof**

Maximum Panel Thickness with Standard Hardware: **.217" (5.5mm)**

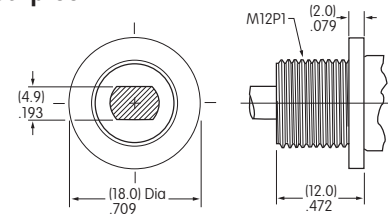

## Panel Cutouts

**For B1 Bushing with Keyway**

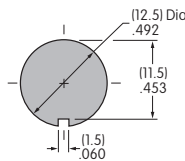

**For B1 Bushing with Locking Ring**

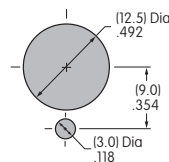

**For B3 Bushing without Keyway**

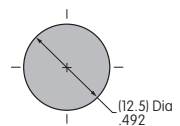

## CONTACT MATERIALS & RATINGS

**W**

Silver

Power Level

3A @ 125V AC & 2A @ 250V AC

**G**

Gold

Logic Level

0.4VA maximum @ 28V AC/DC maximum

Note: Complete explanation of operating range in Supplement section.

## TERMINALS

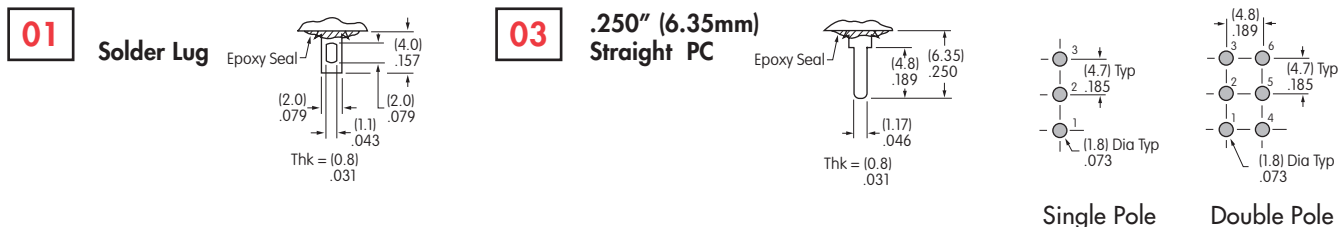

## CAPS & CAP COLORS

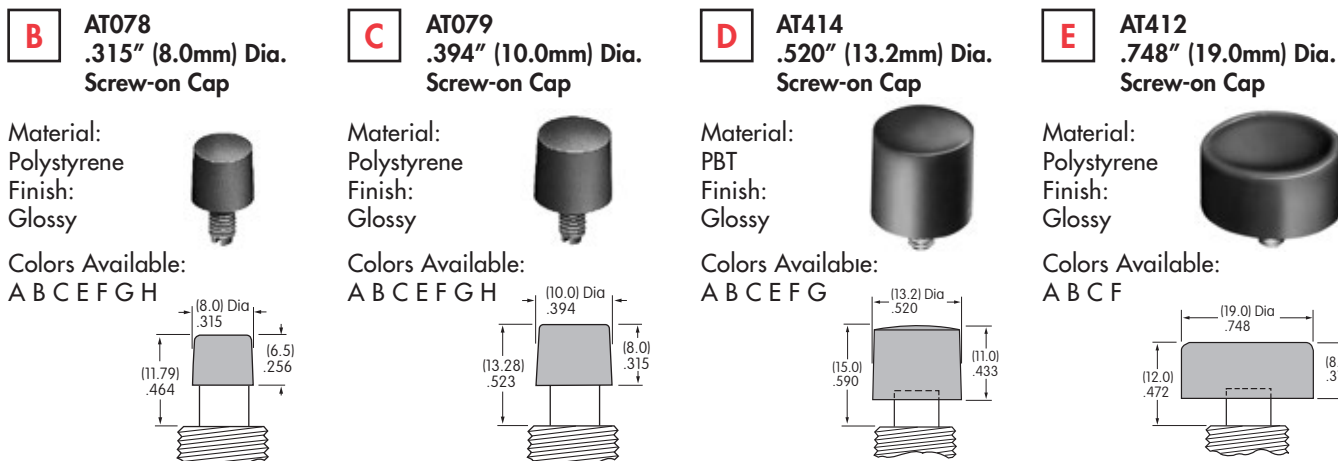

## TYPICAL SWITCH DIMENSIONS

### Solder Lug

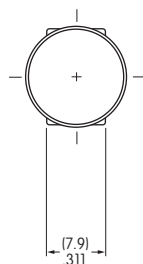

### Single Pole

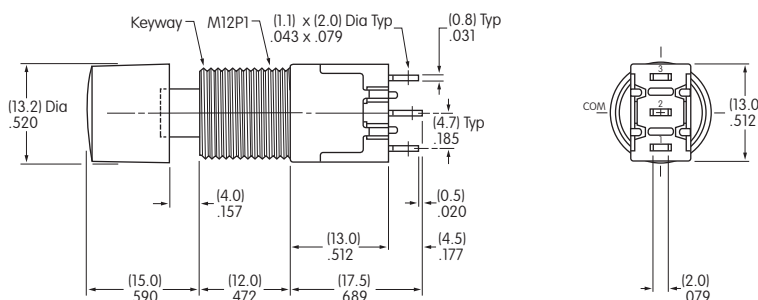

**MBN15SB1W01-DA**

### Solder Lug

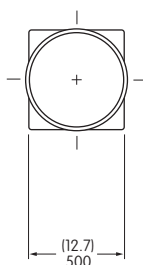

### Double Pole

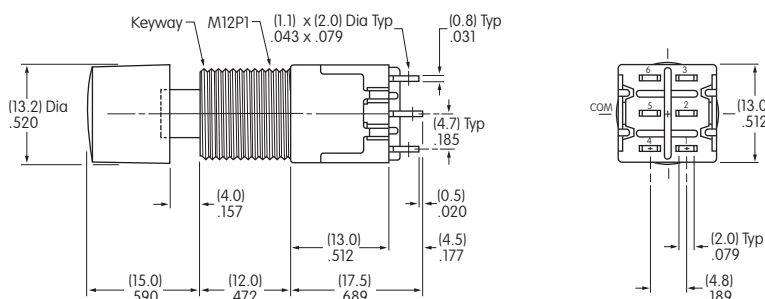

**MBN25SB1W01-DA**



### HARDWARE

#### Standard Hardware for B1 Bushing

##### AT503M Hex Face Nut

Material:  
Brass with Chrome plating

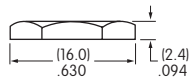
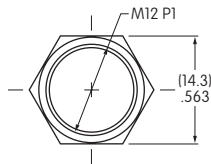

##### AT508 Lockwasher

Material:  
Steel with Zinc/Chromate

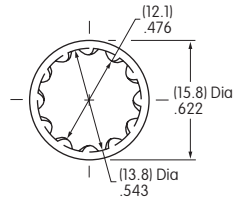

##### AT527M Hex Nut

Material:  
Steel with Nickel plating

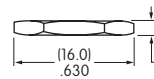
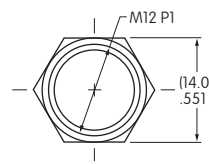

##### AT506M Locking Ring

Material:  
Steel with Zinc/Chromate

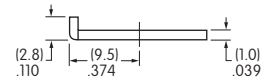
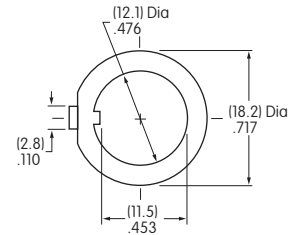

#### Standard Hardware for B3 Bushing

##### AT503M Hex Face Nut

Material:  
Brass with Chrome plating

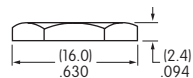
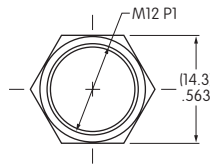

##### AT401P O-ring

Material:  
Nitrile butadiene rubber

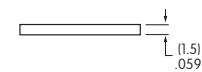
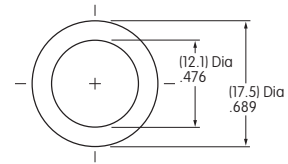

#### Optional Splashproof Boot for B1 Bushing

##### AT4043 Splashproof Boot

Material: Silicone Rubber  
Operating Life (when installed on switch):  
50,000 for momentary  
50,000 for alternate action

When using a splashproof boot, no cap is required.

