

EXTRUSION PROFILE

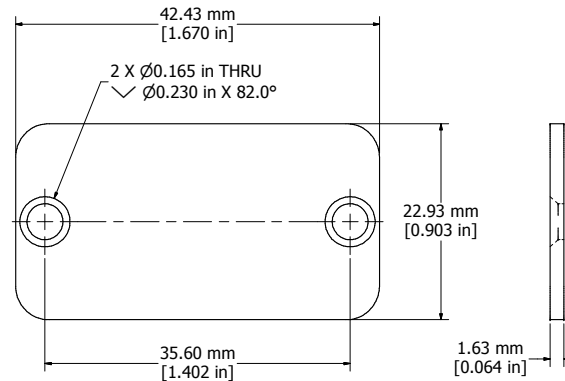

ENDPLATE

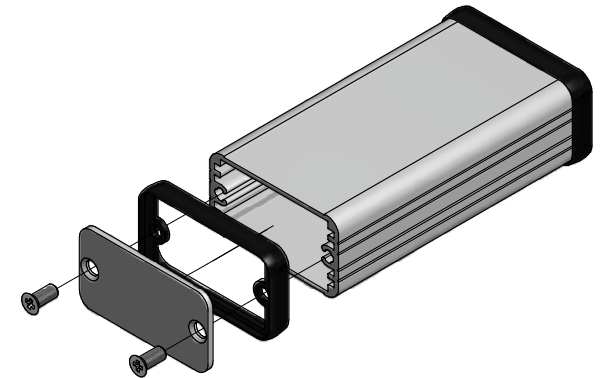

EXPLODED ASSEMBLY VIEW

**\*\*DESIGNED FOR 39MM WIDE PC BOARD\*\***

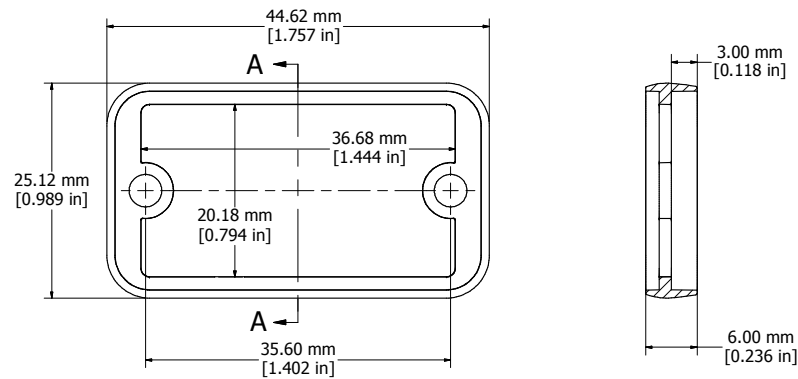
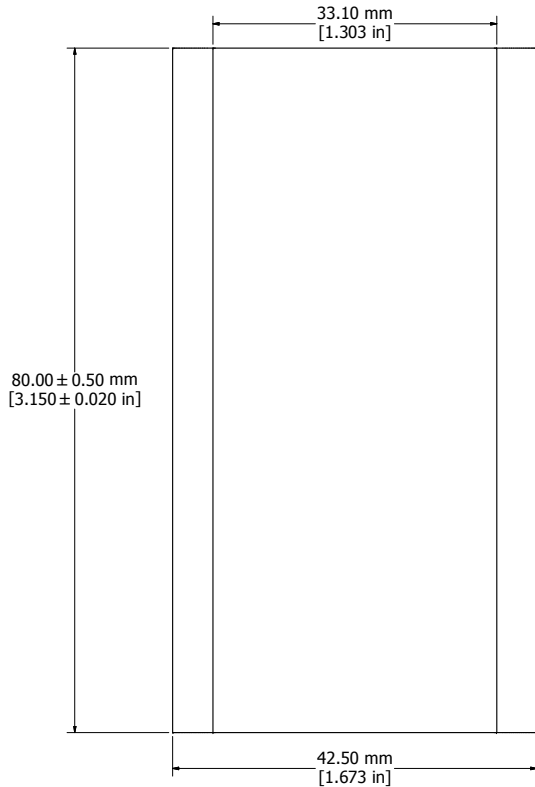

OPEN BEZEL

SECTION A-A

Enclosures can be Factory Modified ( Milling, Drilling, Printing etc. )  
 Contact Factory [mjm@hammondmfg.com](mailto:mjm@hammondmfg.com) for quotes  
 Solid models of this enclosure available in STEP or IGES.

NOTE	
Purchased assembly includes box, plastic bezels, End Panels, Custom #6 Taptight screws and self adhesive rubber feet	
Box made from Extruded Aluminum 6063-T5	
Bezels made with polycarbonate.	
End Plates made from 5052-H32 Aluminum	
1455D801	
PART NUMBERS	
Clear Anodized	1455D801
Black Anodized	1455D801BK
ACCESSORIES	
See website for accessories.	

**HAMMOND MANUFACTURING™**  
**1455D801**  
[www.hammondmfg.com](http://www.hammondmfg.com)