

## TRENCHSTOP™ IGBT 7

## Low Loss Duopack: IGBT with Trench and Fieldstop technology

**Features:**

TRENCHSTOP™ IGBT 7 technology offering

- Very low  $V_{CEsat}$
- Low turn-off losses
- Short tail current
- Reduced EMI
- Humidity robust design
- Very soft, fast recovery anti-parallel diode
- Maximum junction temperature 175°C
- Qualified according to JEDEC for target applications
- Pb-free lead plating; RoHS compliant
- Complete product spectrum and PSpice Models:  
<http://www.infineon.com/igbt7/>

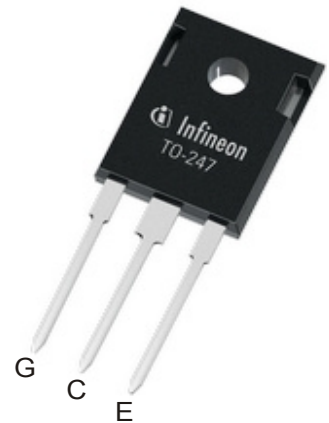
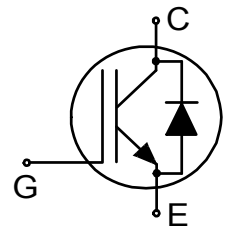
**Applications:**

- Drives
  - Servo
  - GPD
- Industrial Power Supplies
  - Industrial UPS
  - Residential UPS
- Energy Generation
  - Solar Central Inverter
  - Solar String Inverter
  - Solar Pump

**Product Validation:**

Qualified for industrial applications according to the relevant tests of JEDEC47/20/22

**Package pin definition:**

- Pin C & backside - Collector
- Pin E - Emitter
- Pin G - Gate

**Key Performance and Package Parameters**

Type	$V_{CE}$	$I_C$	$V_{CEsat}, T_{vj}=25^{\circ}C$	$T_{vjmax}$	Marking	Package
IKW40N65ET7	650V	40A	1.35V	175°C	K40EET7	PG-TO247-3

### Table of Contents

Description .....	1
Table of Contents .....	2
Maximum Ratings .....	3
Thermal Resistance .....	3
Electrical Characteristics .....	4
Electrical Characteristics Diagrams .....	7
Package Drawing .....	14
Testing Conditions .....	15
Revision History .....	16
Disclaimer .....	17

## TRENCHSTOP™ IGBT 7

## Maximum Ratings

For optimum lifetime and reliability, Infineon recommends operating conditions that do not exceed 80% of the maximum ratings stated in this datasheet.

Parameter	Symbol	Value	Unit
Collector-emitter voltage, $T_{vj} \geq 25^{\circ}\text{C}$	$V_{CE}$	650	V
DC collector current, limited by $T_{vjmax}$ $T_c = 25^{\circ}\text{C}$ $T_c = 100^{\circ}\text{C}$	$I_C$	76.0 49.5	A
Pulsed collector current, $t_p$ limited by $T_{vjmax}^{1)}$	$I_{Cpuls}$	120.0	A
Turn off safe operating area $V_{CE} \leq 650\text{V}$ , $T_{vj} \leq 175^{\circ}\text{C}$ , $t_p = 1\mu\text{s}^2)$	-	120.0	A
Diode forward current, limited by $T_{vjmax}$ $T_c = 25^{\circ}\text{C}$ value limited by bondwire $T_c = 100^{\circ}\text{C}$	$I_F$	72.0 43.5	A
Diode pulsed current, $t_p$ limited by $T_{vjmax}^{1)}$	$I_{Fpuls}$	120.0	A
Gate-emitter voltage Transient Gate-emitter voltage ( $t_p \leq 10\mu\text{s}$ , $D < 0.010$ )	$V_{GE}$	$\pm 20$ $\pm 30$	V
Short circuit withstand time $V_{GE} = 15.0\text{V}$ , $V_{CC} \leq 400\text{V}$ Allowed number of short circuits < 1000 Time between short circuits: $\geq 1.0\text{s}$ $T_{vj} = 150^{\circ}\text{C}$	$t_{SC}$	3	$\mu\text{s}$
Short circuit withstand time $V_{GE} = 15.0\text{V}$ , $V_{CC} \leq 330\text{V}$ Allowed number of short circuits < 1000 Time between short circuits: $\geq 1.0\text{s}$ $T_{vj} = 100^{\circ}\text{C}$	$t_{SC}$	5	$\mu\text{s}$
Power dissipation $T_c = 25^{\circ}\text{C}$ Power dissipation $T_c = 100^{\circ}\text{C}$	$P_{tot}$	230.8 115.4	W
Operating junction temperature	$T_{vj}$	-40...+175	$^{\circ}\text{C}$
Storage temperature	$T_{stg}$	-55...+150	$^{\circ}\text{C}$
Soldering temperature, wave soldering 1.6mm (0.063in.) from case for 10s		260	$^{\circ}\text{C}$
Mounting torque, M3 screw Maximum of mounting processes: 3	$M$	0.6	Nm

## Thermal Resistance

Parameter	Symbol	Conditions	Value			Unit
			min.	typ.	max.	
<b>R<sub>th</sub> Characteristics</b>						
IGBT thermal resistance, junction - case	$R_{th(j-c)}$		-	-	0.65	K/W
Diode thermal resistance, junction - case	$R_{th(j-c)}$		-	-	0.90	K/W
Thermal resistance junction - ambient	$R_{th(j-a)}$		-	-	40	K/W

<sup>1)</sup> Defined by design. Not subject to production test.

<sup>2)</sup> Clamped inductive load current test for each device,  $I_C=120\text{A}$ ,  $V_{CC}=400\text{V}$ ,  $T_c=25^{\circ}\text{C}$ ,  $V_{GE}=20\text{V}$ ,  $L=80\mu\text{H}$ ,  $R_G=10\Omega$ .

## TRENCHSTOP™ IGBT 7

Electrical Characteristic, at  $T_{vj} = 25^{\circ}\text{C}$ , unless otherwise specified

Parameter	Symbol	Conditions	Value			Unit
			min.	typ.	max.	
<b>Static Characteristic</b>						
Collector-emitter saturation voltage	$V_{CEsat}$	$V_{GE} = 15.0\text{V}$ , $I_C = 40.0\text{A}$ $T_{vj} = 25^{\circ}\text{C}$ $T_{vj} = 125^{\circ}\text{C}$ $T_{vj} = 175^{\circ}\text{C}$	-	1.35	1.65	V
Diode forward voltage	$V_F$	$V_{GE} = 0\text{V}$ , $I_F = 40.0\text{A}$ $T_{vj} = 25^{\circ}\text{C}$ $T_{vj} = 125^{\circ}\text{C}$ $T_{vj} = 175^{\circ}\text{C}$	-	1.65	2.00	V
Gate-emitter threshold voltage	$V_{GE(th)}$	$I_C = 0.40\text{mA}$ , $V_{CE} = V_{GE}$	4.3	5.0	5.7	V
Zero gate voltage collector current	$I_{CES}$	$V_{CE} = 650\text{V}$ , $V_{GE} = 0\text{V}$ $T_{vj} = 25^{\circ}\text{C}$ $T_{vj} = 175^{\circ}\text{C}$	-	-	40	$\mu\text{A}$
Gate-emitter leakage current	$I_{GES}$	$V_{CE} = 0\text{V}$ , $V_{GE} = 20\text{V}$	-	-	100	nA
Transconductance	$g_{fs}$	$V_{CE} = 20\text{V}$ , $I_C = 40.0\text{A}$	-	20.5	-	S

Electrical Characteristic, at  $T_{vj} = 25^{\circ}\text{C}$ , unless otherwise specified

Parameter	Symbol	Conditions	Value			Unit
			min.	typ.	max.	
<b>Dynamic Characteristic</b>						
Input capacitance	$C_{ies}$	$V_{CE} = 25\text{V}$ , $V_{GE} = 0\text{V}$ $f = 1000\text{kHz}$	-	2475	-	pF
Output capacitance	$C_{oes}$		-	77	-	
Reverse transfer capacitance	$C_{res}$		-	25	-	
Gate charge	$Q_G$	$V_{CC} = 520\text{V}$ , $I_C = 40.0\text{A}$ , $V_{GE} = 15\text{V}$	-	235.0	-	nC
Internal emitter inductance measured 5mm (0.197 in.) from case	$L_E$		-	13.0	-	nH
Short circuit collector current <sup>1)</sup> Max. 1000 short circuits Time between short circuits: $\geq 1.0\text{s}$	$I_{C(SC)}$	$V_{GE} = 15.0\text{V}$ , $V_{CC} \leq 400\text{V}$ , $t_{SC} \leq 3\mu\text{s}$ $T_{vj} = 150^{\circ}\text{C}$	-	205	-	A

## Switching Characteristic, Inductive Load

Parameter	Symbol	Conditions	Value			Unit
			min.	typ.	max.	

IGBT Characteristic, at  $T_{vj} = 25^{\circ}\text{C}$ 

Turn-on delay time	$t_{d(on)}$	$T_{vj} = 25^{\circ}\text{C}$ ,	-	20	-	ns
Rise time	$t_r$	$V_{CC} = 400\text{V}$ , $I_C = 40.0\text{A}$ , $V_{GE} = 0.0/15.0\text{V}$ ,	-	15	-	ns
Turn-off delay time	$t_{d(off)}$	$R_{G(on)} = 10.0\Omega$ , $R_{G(off)} = 10.0\Omega$ ,	-	310	-	ns
Fall time	$t_f$	$L\sigma = 32\text{nH}$ , $C\sigma = 30\text{pF}$ $L\sigma$ , $C\sigma$ from Fig. E	-	13	-	ns
Turn-on energy	$E_{on}$	Energy losses include "tail" and diode reverse recovery.	-	1.05	-	mJ
Turn-off energy	$E_{off}$		-	0.59	-	mJ
Total switching energy	$E_{ts}$		-	1.64	-	mJ

<sup>1)</sup> Allowed number of short circuits: <1000; time between short circuits >1s.

## TRENCHSTOP™ IGBT 7

Turn-on delay time	$t_{d(on)}$	$T_{vj} = 25^{\circ}\text{C}$ , $V_{CC} = 400\text{V}$ , $I_C = 20.0\text{A}$ , $V_{GE} = 0.0/15.0\text{V}$ , $R_{G(on)} = 10.0\Omega$ , $R_{G(off)} = 10.0\Omega$ , $L\sigma = 32\text{nH}$ , $C\sigma = 30\text{pF}$ $L\sigma$ , $C\sigma$ from Fig. E Energy losses include "tail" and diode reverse recovery.	-	19	-	ns
Rise time	$t_r$		-	9	-	ns
Turn-off delay time	$t_{d(off)}$		-	330	-	ns
Fall time	$t_f$		-	17	-	ns
Turn-on energy	$E_{on}$		-	0.45	-	mJ
Turn-off energy	$E_{off}$		-	0.26	-	mJ
Total switching energy	$E_{ts}$		-	0.71	-	mJ

Diode Characteristic, at  $T_{vj} = 25^{\circ}\text{C}$ 

Diode reverse recovery time	$t_{rr}$	$T_{vj} = 25^{\circ}\text{C}$ , $V_R = 400\text{V}$ , $I_F = 40.0\text{A}$ , $di_F/dt = 1779\text{A}/\mu\text{s}$	-	85	-	ns
Diode reverse recovery charge	$Q_{rr}$		-	0.95	-	$\mu\text{C}$
Diode peak reverse recovery current	$I_{rrm}$		-	22.0	-	A
Diode peak rate of fall of reverse recovery current during $t_b$	$di_{rr}/dt$		-	-380	-	$\text{A}/\mu\text{s}$
Diode reverse recovery time	$t_{rr}$	$T_{vj} = 25^{\circ}\text{C}$ , $V_R = 400\text{V}$ , $I_F = 20.0\text{A}$ , $di_F/dt = 2381\text{A}/\mu\text{s}$	-	59	-	ns
Diode reverse recovery charge	$Q_{rr}$		-	0.70	-	$\mu\text{C}$
Diode peak reverse recovery current	$I_{rrm}$		-	24.5	-	A
Diode peak rate of fall of reverse recovery current during $t_b$	$di_{rr}/dt$		-	-520	-	$\text{A}/\mu\text{s}$

## Switching Characteristic, Inductive Load

Parameter	Symbol	Conditions	Value			Unit
			min.	typ.	max.	
<b>IGBT Characteristic, at <math>T_{vj} = 175^{\circ}\text{C}</math></b>						
Turn-on delay time	$t_{d(on)}$	$T_{vj} = 175^{\circ}\text{C}$ , $V_{CC} = 400\text{V}$ , $I_C = 40.0\text{A}$ , $V_{GE} = 0.0/15.0\text{V}$ , $R_{G(on)} = 10.0\Omega$ , $R_{G(off)} = 10.0\Omega$ , $L\sigma = 32\text{nH}$ , $C\sigma = 30\text{pF}$ $L\sigma$ , $C\sigma$ from Fig. E Energy losses include "tail" and diode reverse recovery.	-	23	-	ns
Rise time	$t_r$		-	20	-	ns
Turn-off delay time	$t_{d(off)}$		-	380	-	ns
Fall time	$t_f$		-	57	-	ns
Turn-on energy	$E_{on}$		-	1.65	-	mJ
Turn-off energy	$E_{off}$		-	1.13	-	mJ
Total switching energy	$E_{ts}$		-	2.78	-	mJ
Turn-on delay time	$t_{d(on)}$	$T_{vj} = 175^{\circ}\text{C}$ , $V_{CC} = 400\text{V}$ , $I_C = 20.0\text{A}$ , $V_{GE} = 0.0/15.0\text{V}$ , $R_{G(on)} = 10.0\Omega$ , $R_{G(off)} = 10.0\Omega$ , $L\sigma = 32\text{nH}$ , $C\sigma = 30\text{pF}$ $L\sigma$ , $C\sigma$ from Fig. E Energy losses include "tail" and diode reverse recovery.	-	21	-	ns
Rise time	$t_r$		-	12	-	ns
Turn-off delay time	$t_{d(off)}$		-	430	-	ns
Fall time	$t_f$		-	70	-	ns
Turn-on energy	$E_{on}$		-	0.84	-	mJ
Turn-off energy	$E_{off}$		-	0.59	-	mJ
Total switching energy	$E_{ts}$		-	1.43	-	mJ

## TRENCHSTOP™ IGBT 7

Diode Characteristic, at  $T_{vj} = 175^{\circ}\text{C}$ 

Diode reverse recovery time	$t_{rr}$	$T_{vj} = 175^{\circ}\text{C},$ $V_R = 400\text{V},$ $I_F = 40.0\text{A},$ $di_F/dt = 1660\text{A}/\mu\text{s}$	-	145	-	ns
Diode reverse recovery charge	$Q_{rr}$		-	2.80	-	$\mu\text{C}$
Diode peak reverse recovery current	$I_{rrm}$		-	35.0	-	A
Diode peak rate of fall of reverse recovery current during $t_b$	$di_{rr}/dt$		-	-290	-	$\text{A}/\mu\text{s}$
Diode reverse recovery time	$t_{rr}$	$T_{vj} = 175^{\circ}\text{C},$ $V_R = 400\text{V},$ $I_F = 20.0\text{A},$ $di_F/dt = 1881\text{A}/\mu\text{s}$	-	105	-	ns
Diode reverse recovery charge	$Q_{rr}$		-	2.02	-	$\mu\text{C}$
Diode peak reverse recovery current	$I_{rrm}$		-	35.0	-	A
Diode peak rate of fall of reverse recovery current during $t_b$	$di_{rr}/dt$		-	-425	-	$\text{A}/\mu\text{s}$

TRENCHSTOP™ IGBT 7

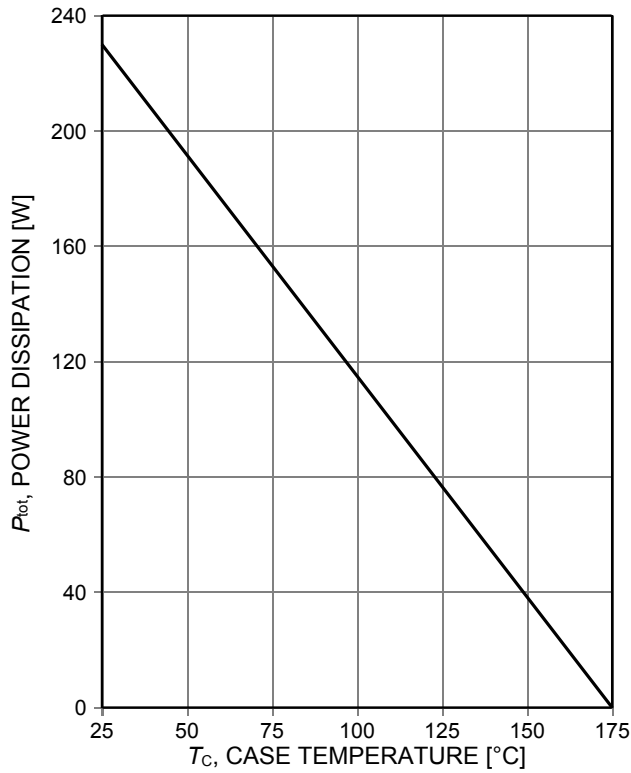

Figure 1. Power dissipation as a function of case temperature ( $T_{vj} \leq 175^\circ\text{C}$ )

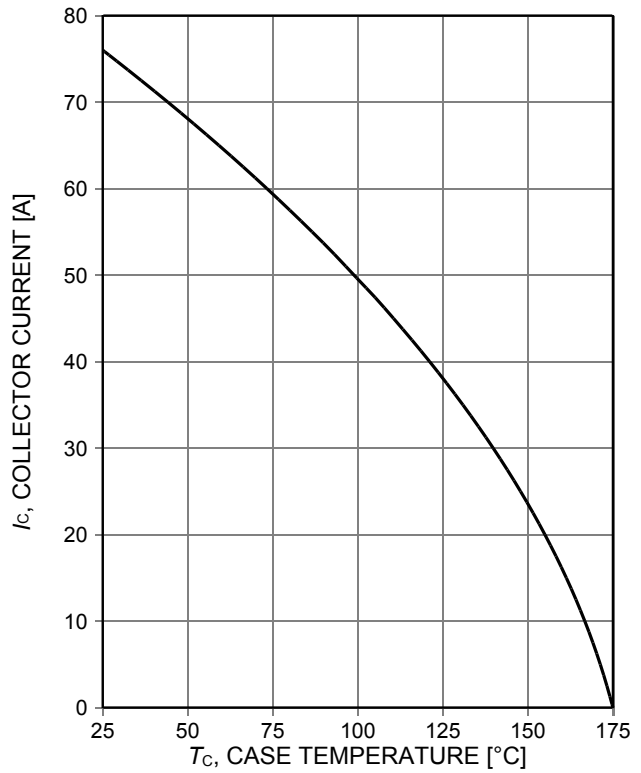

Figure 2. Collector current as a function of case temperature ( $V_{GE} \geq 15\text{V}$ ,  $T_{vj} \leq 175^\circ\text{C}$ )

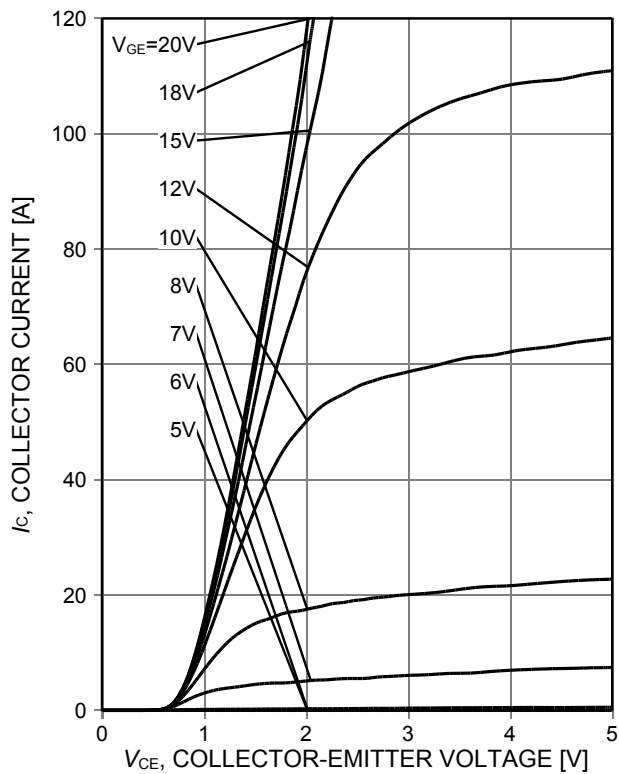

Figure 3. Typical output characteristic ( $T_{vj} = 25^\circ\text{C}$ )

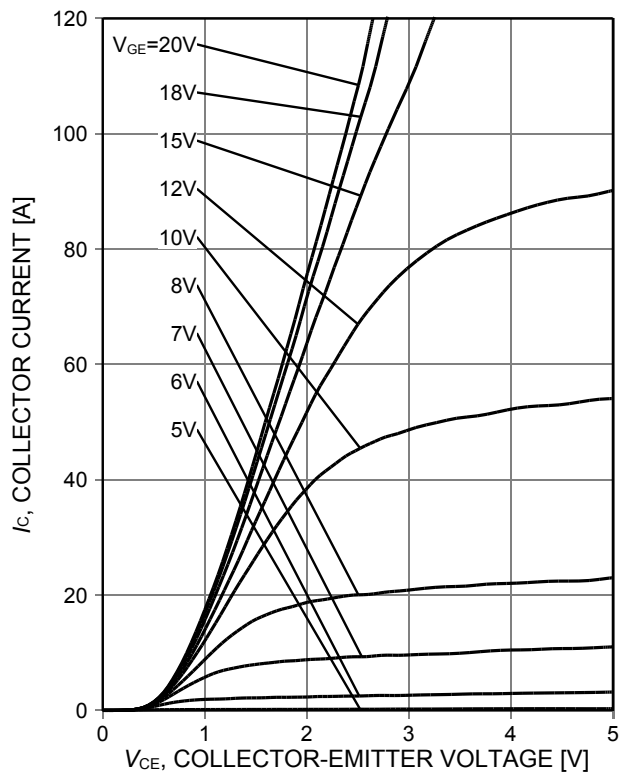

Figure 4. Typical output characteristic ( $T_{vj} = 175^\circ\text{C}$ )

TRENCHSTOP™ IGBT 7

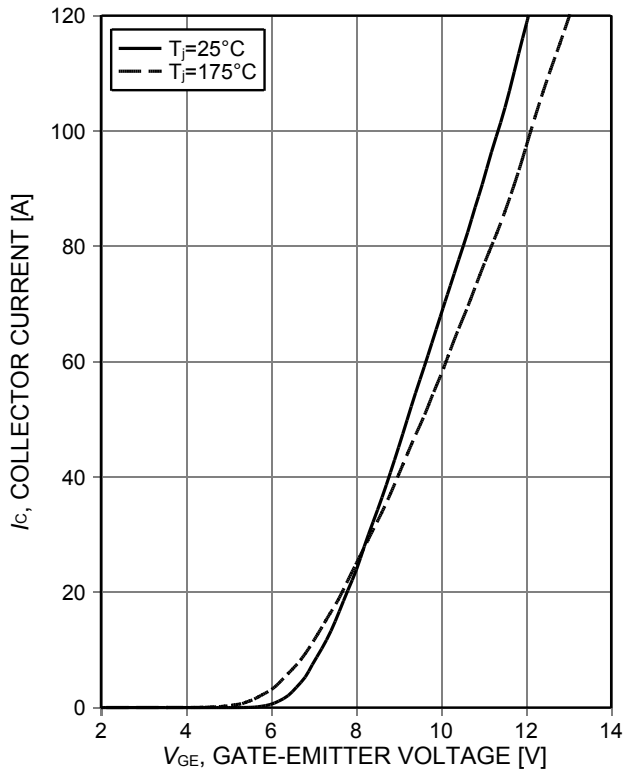

Figure 5. Typical transfer characteristic (V<sub>CE</sub>=20V)

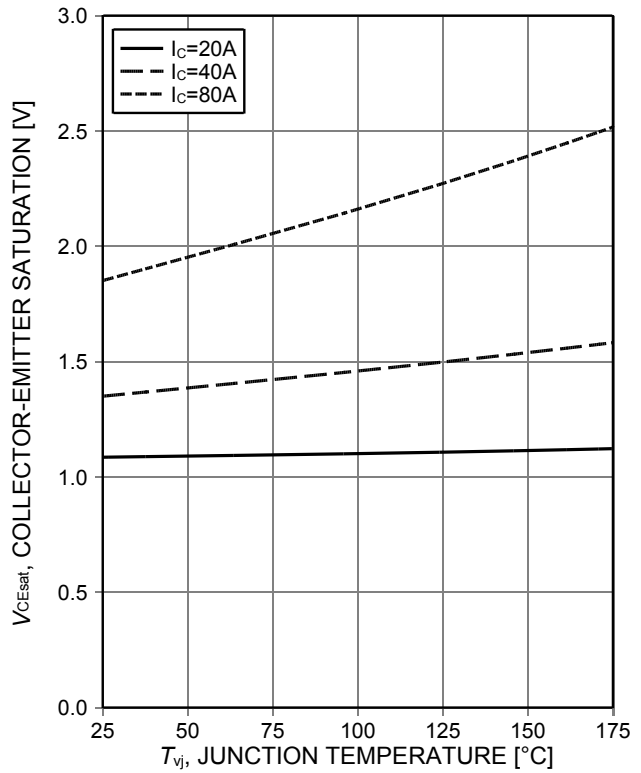

Figure 6. Typical collector-emitter saturation voltage as a function of junction temperature (V<sub>GE</sub>=15V)

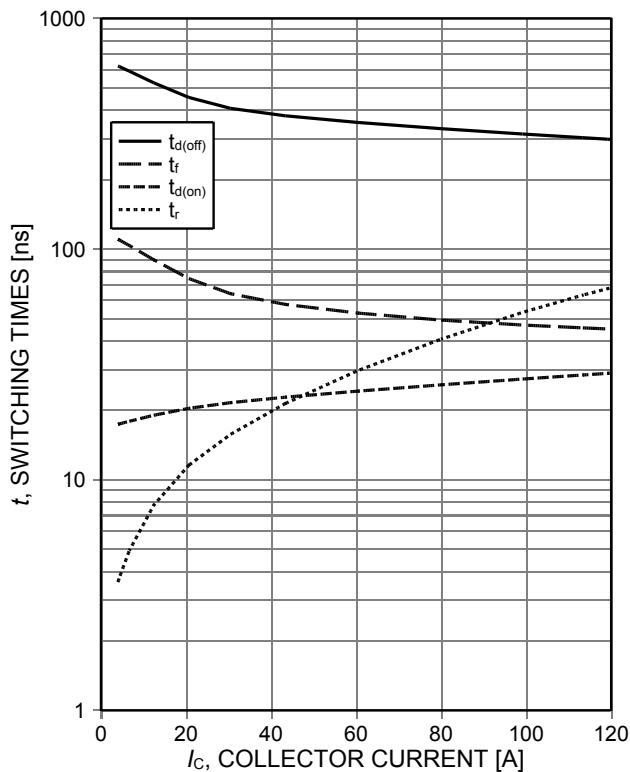

Figure 7. Typical switching times as a function of collector current (inductive load, T<sub>vj</sub>=175°C, V<sub>CE</sub>=400V, V<sub>GE</sub>=15/0V, R<sub>G</sub>=10Ω, Dynamic test circuit in Figure E)

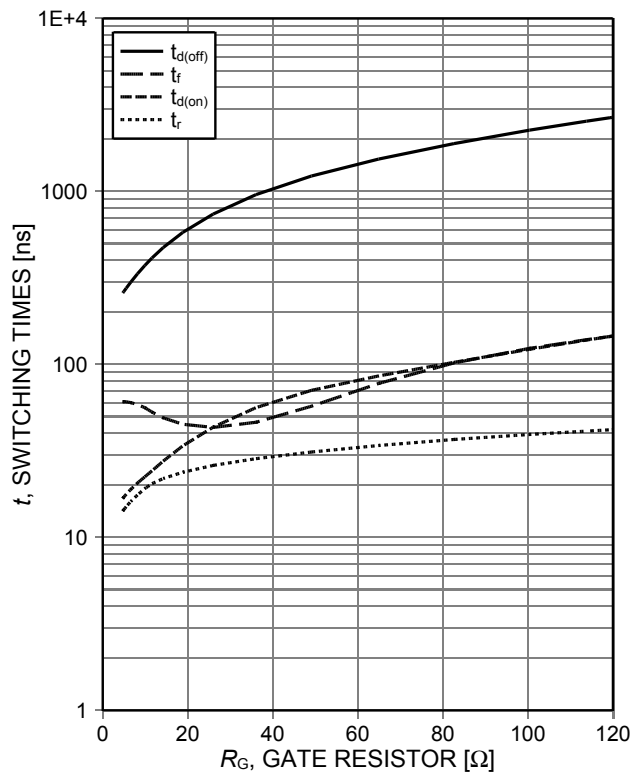

Figure 8. Typical switching times as a function of gate resistor (inductive load, T<sub>vj</sub>=175°C, V<sub>CE</sub>=400V, V<sub>GE</sub>=15/0V, I<sub>C</sub>=40A, Dynamic test circuit in Figure E)



TRENCHSTOP™ IGBT 7

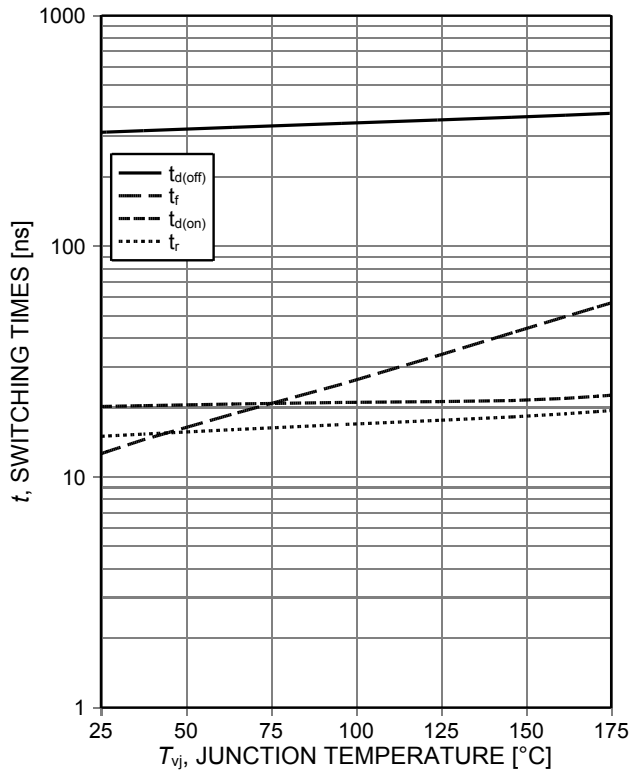

Figure 9. **Typical switching times as a function of junction temperature**  
 (inductive load,  $V_{CE}=400V$ ,  $V_{GE}=15/0V$ ,  $I_C=40A$ ,  $R_G=10\Omega$ , Dynamic test circuit in Figure E)

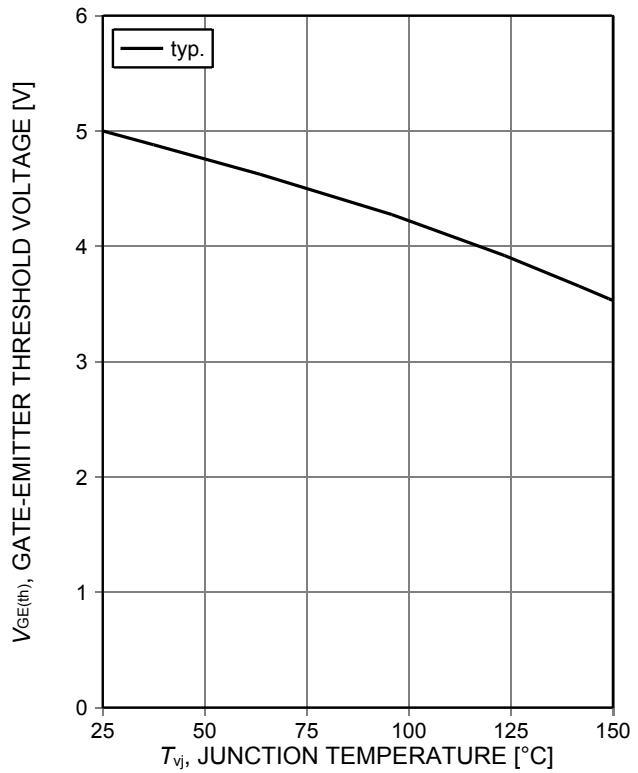

Figure 10. **Gate-emitter threshold voltage as a function of junction temperature**  
 ( $I_C=0.4mA$ )

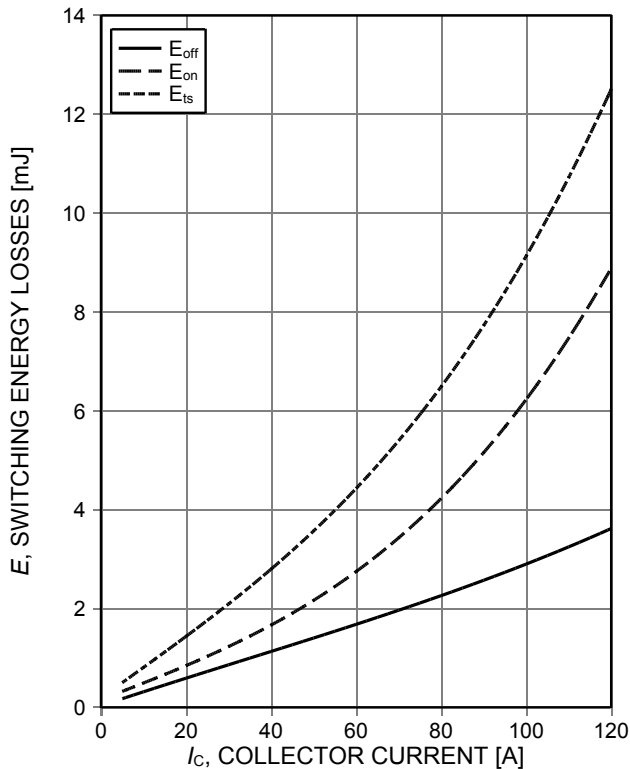

Figure 11. **Typical switching energy losses as a function of collector current**  
 (inductive load,  $T_{vj}=175^\circ C$ ,  $V_{CE}=400V$ ,  $V_{GE}=15/0V$ ,  $R_G=10\Omega$ , Dynamic test circuit in Figure E)

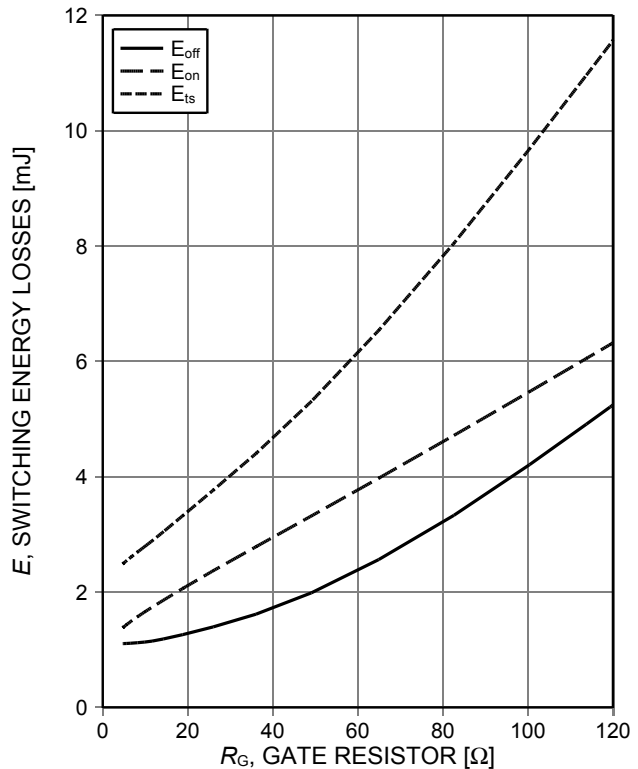

Figure 12. **Typical switching energy losses as a function of gate resistor**  
 (inductive load,  $T_{vj}=175^\circ C$ ,  $V_{CE}=400V$ ,  $V_{GE}=15/0V$ ,  $I_C=40A$ , Dynamic test circuit in Figure E)

TRENCHSTOP™ IGBT 7

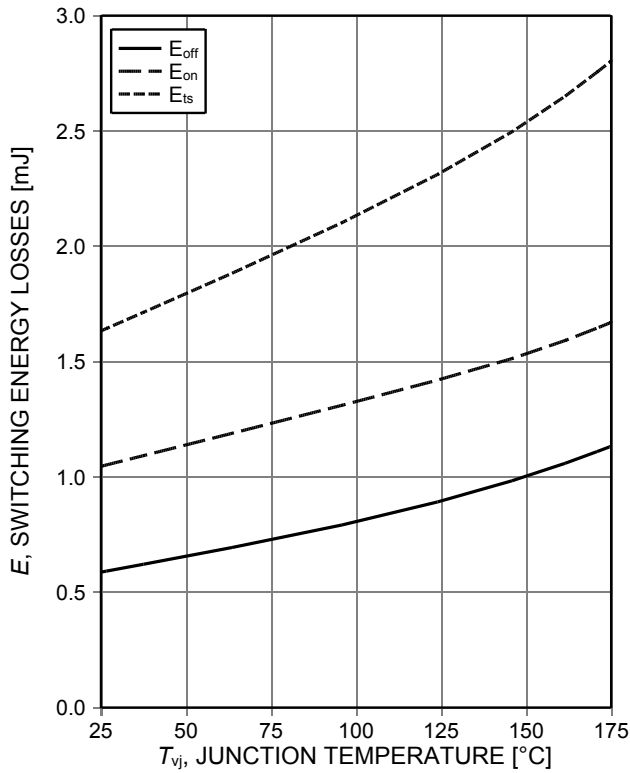

Figure 13. **Typical switching energy losses as a function of junction temperature** (inductive load,  $V_{CE}=400V$ ,  $V_{GE}=15/0V$ ,  $I_C=40A$ ,  $R_G=10\Omega$ , Dynamic test circuit in Figure E)

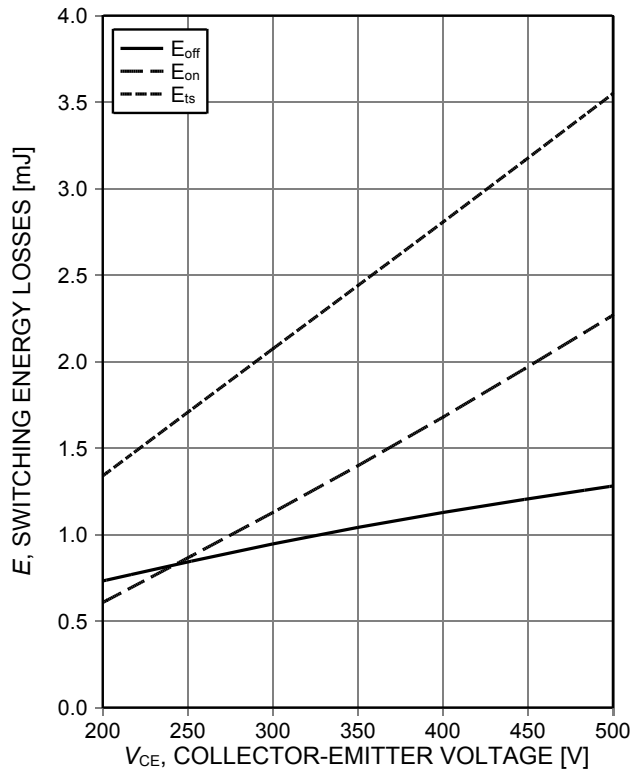

Figure 14. **Typical switching energy losses as a function of collector-emitter voltage** (inductive load,  $T_{vj}=175^\circ C$ ,  $V_{GE}=15/0V$ ,  $I_C=40A$ ,  $R_G=10\Omega$ , Dynamic test circuit in Figure E)

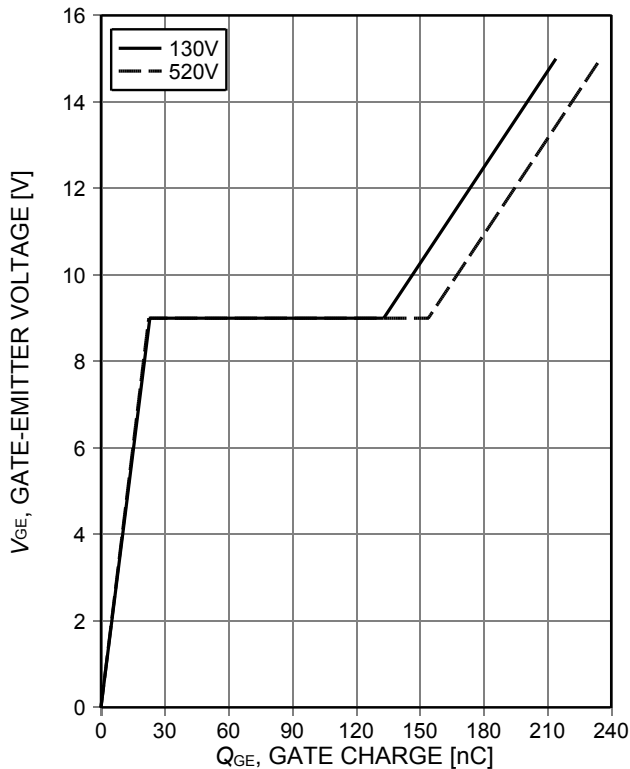

Figure 15. **Typical gate charge** ( $I_C=40A$ )

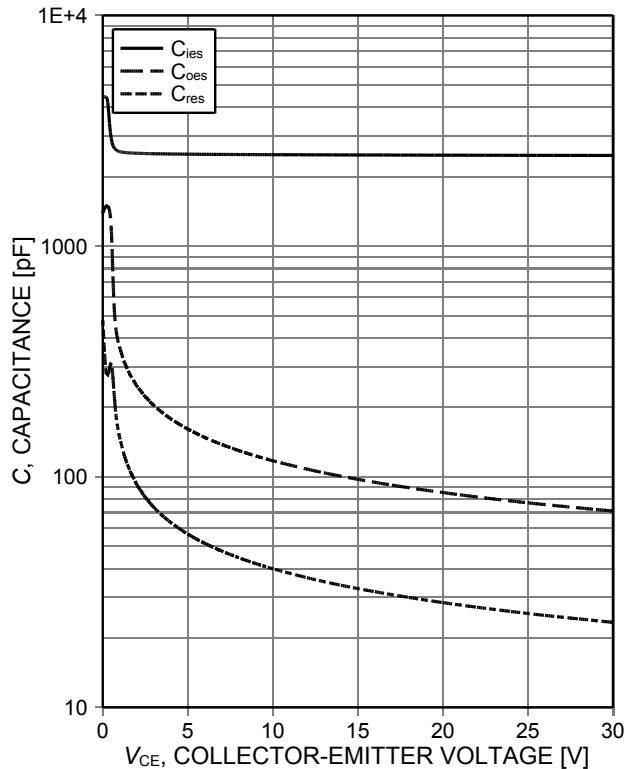

Figure 16. **Typical capacitance as a function of collector-emitter voltage** ( $V_{GE}=0V$ ,  $f=1MHz$ )

TRENCHSTOP™ IGBT 7

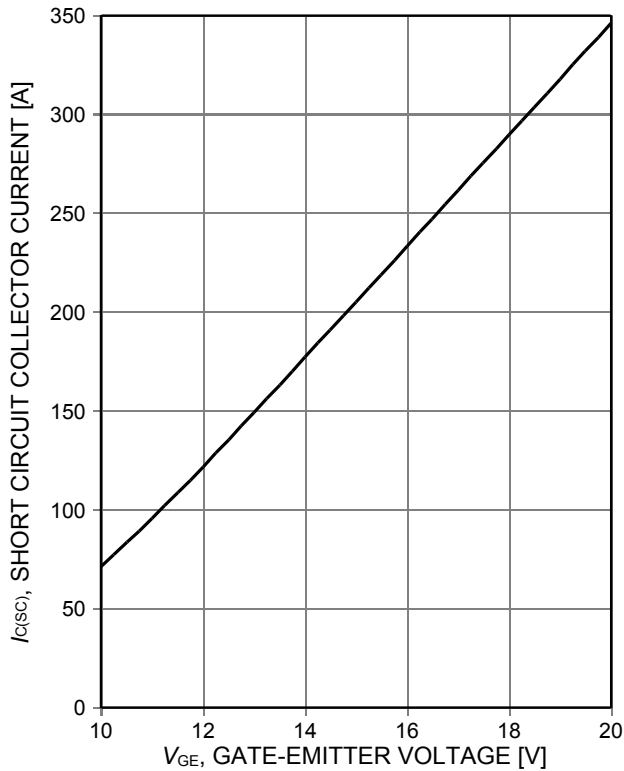

Figure 17. Typical short circuit collector current as a function of gate-emitter voltage ( $V_{CE} \leq 400V$ ,  $T_{vj} \leq 150^\circ C$ )

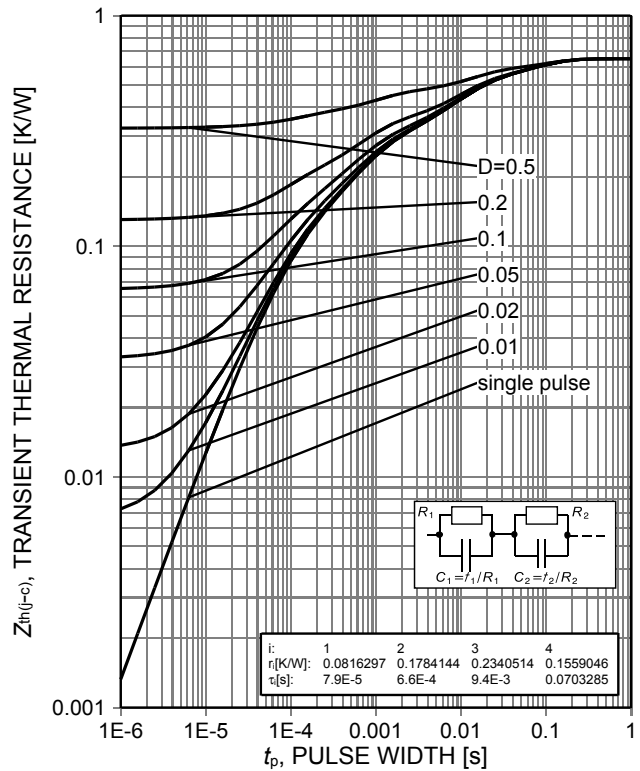

Figure 18. IGBT transient thermal resistance ( $D=t_p/T$ )

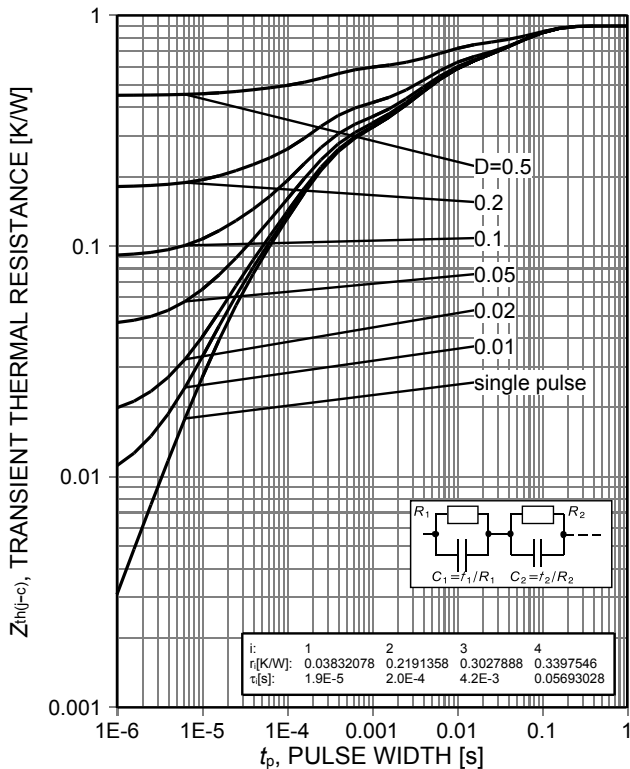

Figure 19. Diode transient thermal impedance as a function of pulse width ( $D=t_p/T$ )

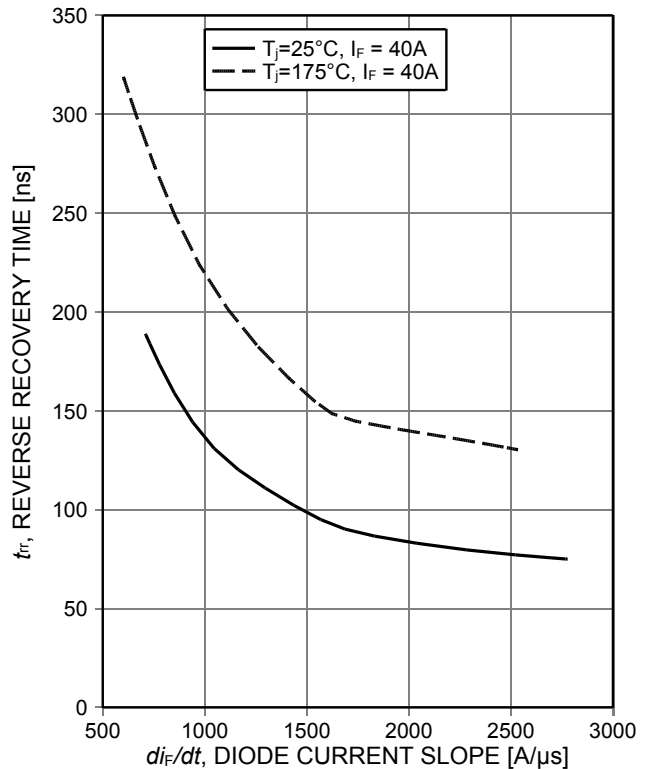

Figure 20. Typical reverse recovery time as a function of diode current slope ( $V_R=400V$ )

TRENCHSTOP™ IGBT 7

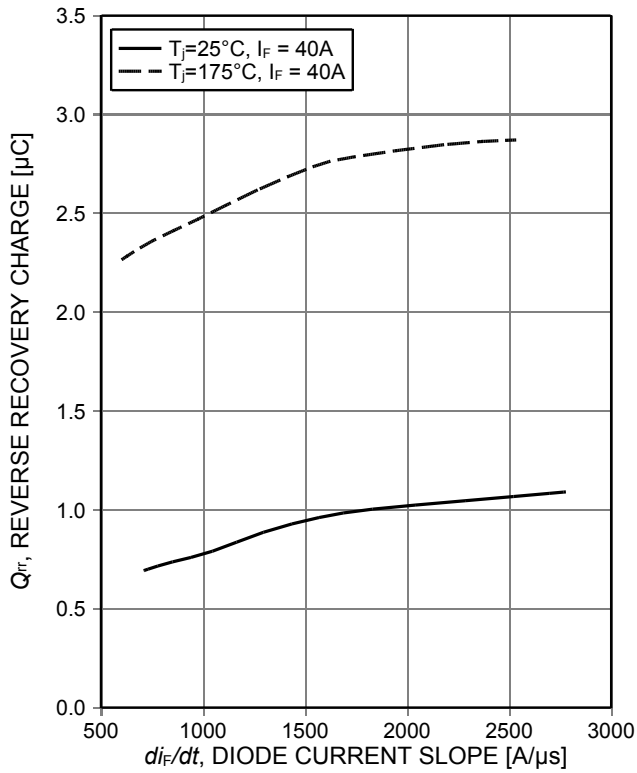

Figure 21. Typical reverse recovery charge as a function of diode current slope (VR=400V)

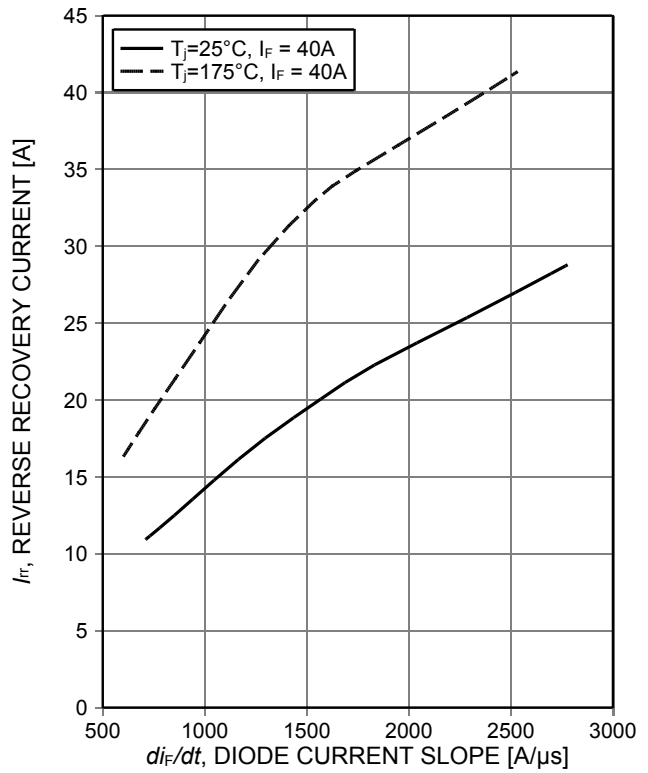

Figure 22. Typical reverse recovery current as a function of diode current slope (VR=400V)

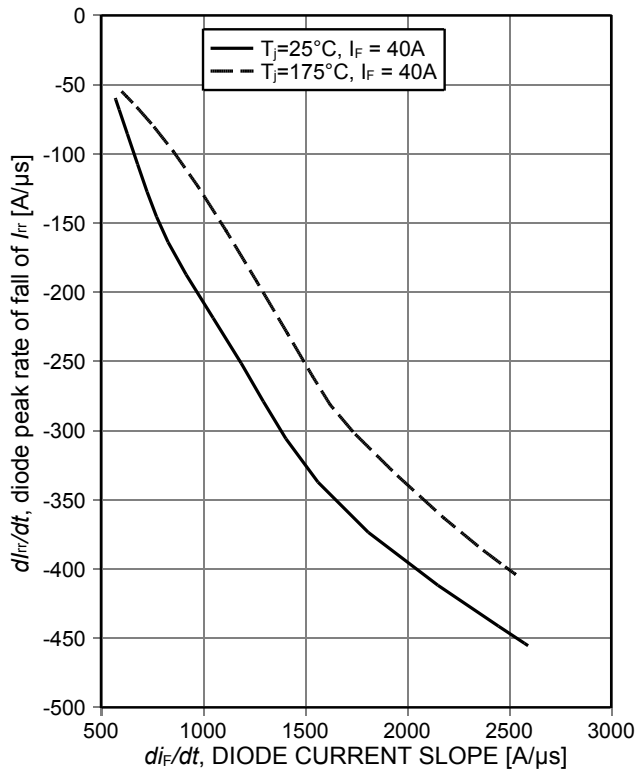

Figure 23. Typical diode peak rate of fall of reverse recovery current as a function of diode current slope (VR=400V)

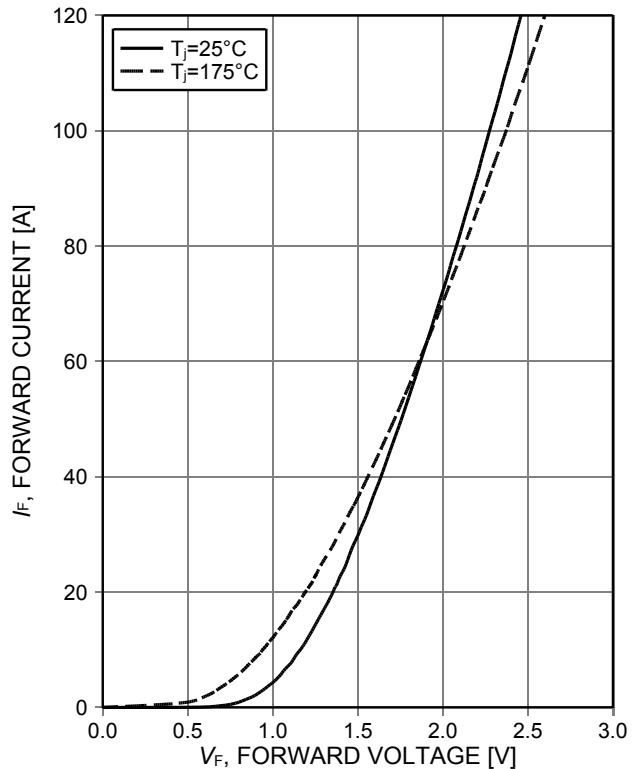

Figure 24. Typical diode forward current as a function of forward voltage

TRENCHSTOP™ IGBT 7

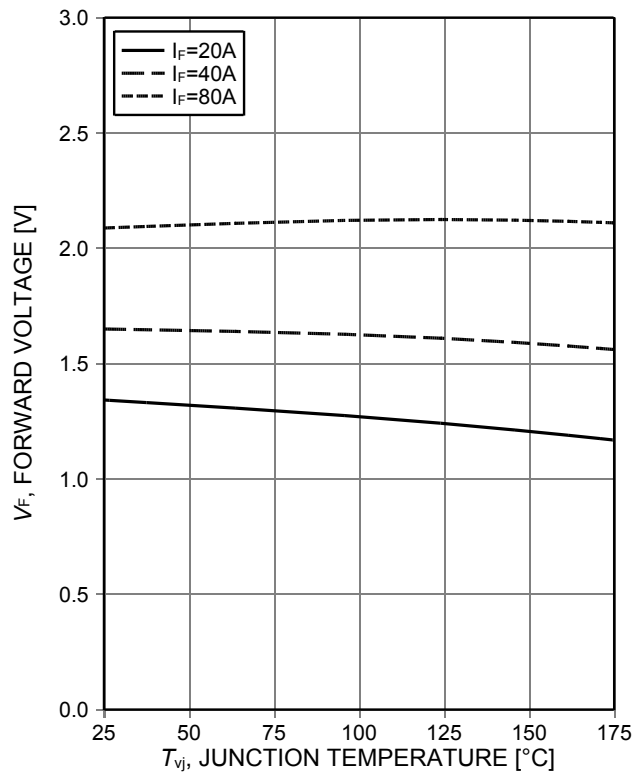
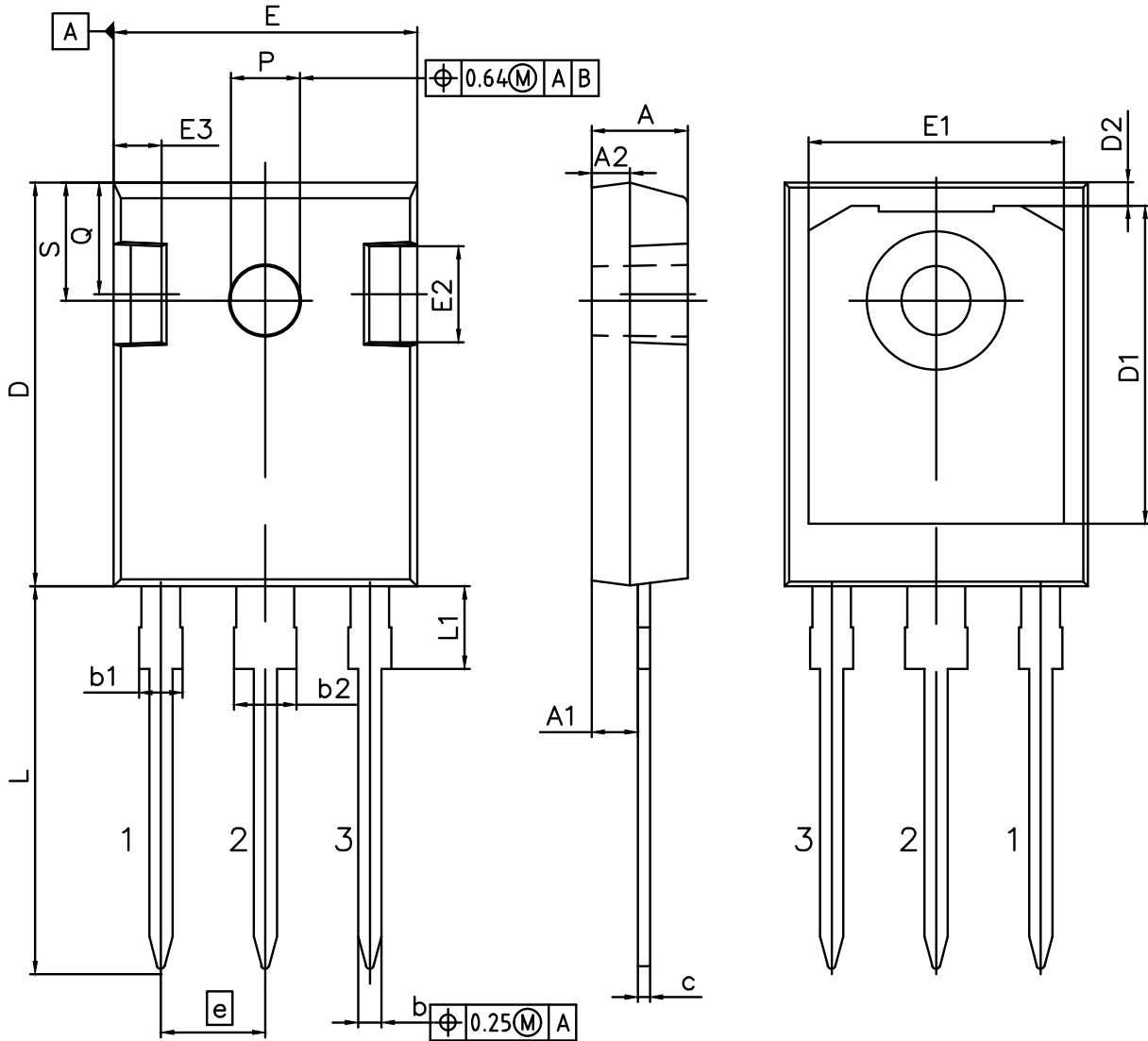

Figure 25. Typical diode forward voltage as a function of junction temperature

Package Drawing PG-TO247-3



DIMENSIONS	MILLIMETERS	
	MIN.	MAX.
A	4.70	5.30
A1	2.20	2.60
A2	1.50	2.50
b	1.00	1.40
b1	1.60	2.41
b2	2.57	3.43
c	0.38	0.89
D	20.70	21.50
D1	13.08	17.65
D2	0.51	1.35
E	15.50	16.30
E1	12.38	14.15
E2	3.40	5.10
E3	1.00	2.60
e	5.44	
L	19.80	20.40
L1	3.85	4.50
P	3.50	3.70
Q	5.35	6.25
S	6.04	6.30

<b>DOCUMENT NO.</b> Z8B00003327
<b>REVISION</b> 06
<b>SCALE 3:1</b> 0 1 2 3 4 5mm 
<b>EUROPEAN PROJECTION</b> 
<b>ISSUE DATE</b> 25.07.2018

Testing Conditions

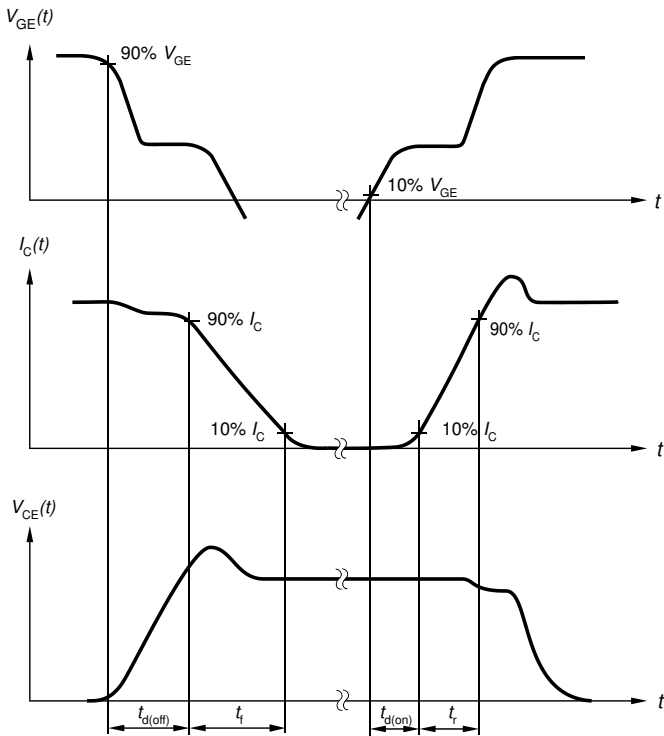

Figure A. Definition of switching times

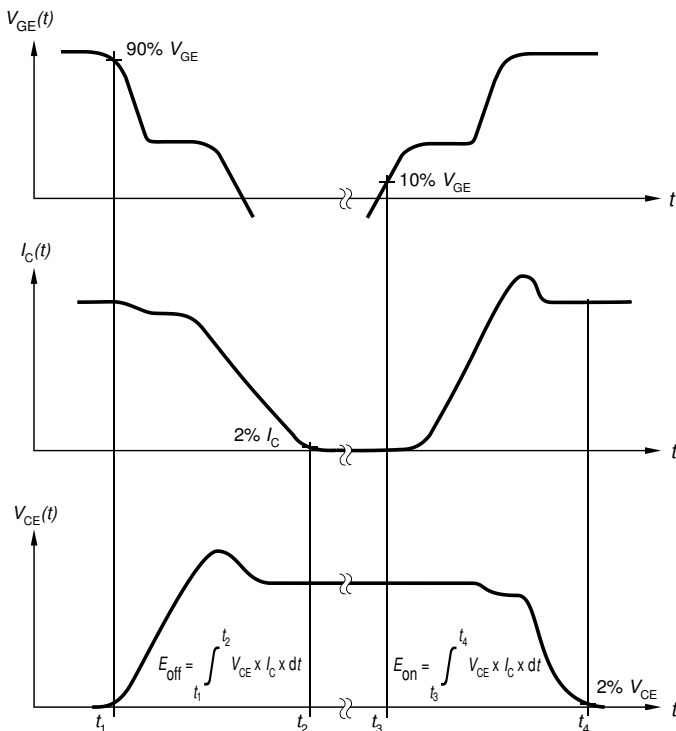

Figure B. Definition of switching losses

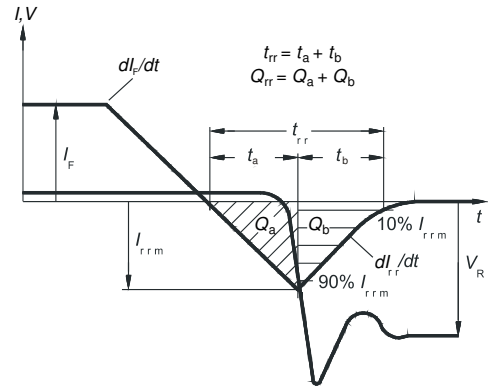

Figure C. Definition of diode switching characteristics

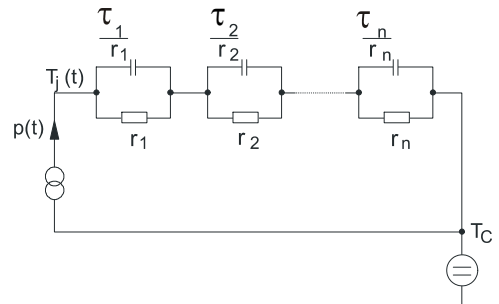

Figure D. Thermal equivalent circuit

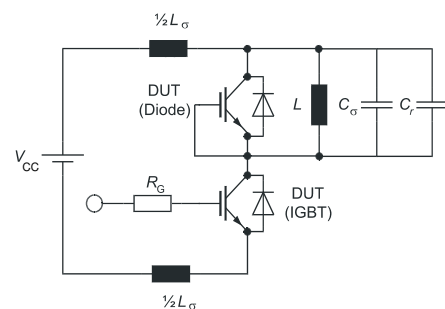

Figure E. Dynamic test circuit  
Parasitic inductance  $L_{\sigma}$ ,  
parasitic capacitor  $C_{\sigma}$ ,  
relief capacitor  $C_r$ ,  
(only for ZVT switching)

---

**TRENCHSTOP™ IGBT 7****Revision History**

---

IKW40N65ET7

**Revision: 2020-11-11, Rev. 2.2**

---

Previous Revision

Revision	Date	Subjects (major changes since last revision)
2.1	2020-05-12	Final data sheet
2.2	2020-11-11	Additional short circuit specification



## Trademarks

All referenced product or service names and trademarks are the property of their respective owners.

**Published by**  
**Infineon Technologies AG**  
**81726 München, Germany**  
**© Infineon Technologies AG 2020.**  
**All Rights Reserved.**

## Important Notice

The information given in this document shall in no event be regarded as a guarantee of conditions or characteristics ("Beschaffenheitsgarantie"). With respect to any examples, hints or any typical values stated herein and/or any information regarding the application of the product, Infineon Technologies hereby disclaims any and all warranties and liabilities of any kind, including without limitation warranties of non-infringement of intellectual property rights of any third party.

In addition, any information given in this document is subject to customer's compliance with its obligations stated in this document and any applicable legal requirements, norms and standards concerning customer's products and any use of the product of Infineon Technologies in customer's applications.

The data contained in this document is exclusively intended for technically trained staff. It is the responsibility of customer's technical departments to evaluate the suitability of the product for the intended application and the completeness of the product information given in this document with respect to such application.

For further information on the product, technology, delivery terms and conditions and prices please contact your nearest Infineon Technologies office ([www.infineon.com](http://www.infineon.com)).

Please note that this product is not qualified according to the AEC Q100 or AEC Q101 documents of the Automotive Electronics Council.

## Warnings

Due to technical requirements products may contain dangerous substances. For information on the types in question please contact your nearest Infineon Technologies office.

Except as otherwise explicitly approved by Infineon Technologies in a written document signed by authorized representatives of Infineon Technologies, Infineon Technologies' products may not be used in any applications where a failure of the product or any consequences of the use thereof can reasonably be expected to result in personal injury.