

# Optocoupler, Phototransistor Output, Low Input Current, With Base Connection, 5300 V<sub>RMS</sub>

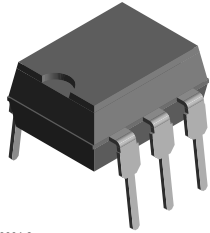

i179004-3

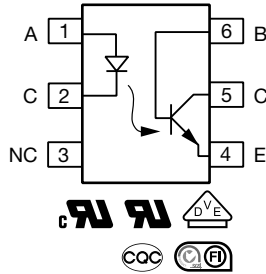

## FEATURES

- Very high CTR at  $I_F = 1.0 \text{ mA}$ ,  $V_{CE} = 0.5 \text{ V}$
- Specified minimum CTR at  $I_F = 0.5 \text{ mA}$
- $V_{CE} = 1.5 \text{ V} \geq 32 \%$  (typ. 120 %)
- Good CTR linearity with forward current
- Low CTR degradation
- High collector-emitter voltage,  $V_{CEO} = 55 \text{ V}$
- Isolation test voltage: 5300 V<sub>RMS</sub>
- Low current input
- Low coupling capacitance
- High common mode transient immunity
- Material categorization: for definitions of compliance please see [www.vishay.com/doc?99912](http://www.vishay.com/doc?99912)



RoHS COMPLIANT

## LINKS TO ADDITIONAL RESOURCES



Product Page

## DESCRIPTION

The SFH608 is an optocoupler designed for high current transfer ratio at low input currents with the output transistor saturated. This makes the device ideal for low current switching applications. The SFH608 is packaged in a six pin plastic DIP.

## AGENCY APPROVALS

- [UL 1577](#)
- [cUL](#)
- [DIN EN 60747-5-5 \(VDE 0884\)](#), available with option 1
- [BSI](#)
- [CQC GB4943.1](#)
- [CQC GB8898](#)
- [FIMKO](#)

## APPLICATIONS

- Telecommunications
- Industrial controls
- Office machines
- Microprocessor system interfaces

ORDERING INFORMATION				
S	F	H	6	0
8	-	#	X	0
#	#	#	T	
PART NUMBER			CTR BIN	PACKAGE OPTION
			TAPE AND REEL	
AGENCY CERTIFIED / PACKAGE	CTR (%)			
UL, cUL, BSI, CQC	63 to 125	100 to 200	160 to 320	250 to 500
DIP-6	SFH608-2	SFH608-3	SFH608-4	SFH608-5
DIP-6, 400 mil, option 6	SFH608-2X006	SFH608-3X006	-	-
SMD-6, option 7	-	SFH608-3X007 <sup>(1)</sup>	SFH608-4X007 <sup>(1)</sup>	SFH608-5X007
UL, cUL, BSI, CQC, VDE (option 1)	63 to 125	100 to 200	160 to 320	250 to 500
DIP-6	-	SFH608-3X001	SFH608-4X001	-
DIP-6, 400 mil, option 6	-	-	SFH608-4X016	-

## Notes

- Additional options may be possible, please contact sales office
- <sup>(1)</sup> Also available in tubes; do not add T to end



ABSOLUTE MAXIMUM RATINGS (T <sub>amb</sub> = 25 °C, unless otherwise specified)				
PARAMETER	TEST CONDITION	SYMBOL	VALUE	UNIT
<b>INPUT</b>				
Reverse voltage		V <sub>R</sub>	6	V
DC forward current		I <sub>F</sub>	50	mA
Surge forward current	t <sub>p</sub> ≤ 10 μs	I <sub>FSM</sub>	2.5	A
Total power dissipation		P <sub>diss</sub>	70	mW
<b>OUTPUT</b>				
Collector emitter voltage		V <sub>CE</sub>	55	V
Collector base voltage		V <sub>CBO</sub>	55	V
Emitter base voltage		V <sub>EBO</sub>	7	V
Collector current		I <sub>C</sub>	50	mA
Surge collector current	t <sub>p</sub> ≤ 1.0 ms		100	mA
Total power dissipation		P <sub>diss</sub>	150	mW
<b>COUPLER</b>				
Storage temperature range		T <sub>stg</sub>	-55 to +150	°C
Operating temperature range		T <sub>amb</sub>	-55 to +100	°C
Soldering temperature <sup>(1)</sup>	Max. 10 s, dip soldering; distance to seating plane ≥ 1.5 mm	T <sub>slid</sub>	260	°C

**Notes**

- Stresses in excess of the absolute maximum ratings can cause permanent damage to the device. Functional operation of the device is not implied at these or any other conditions in excess of those given in the operational sections of this document. Exposure to absolute maximum ratings for extended periods of the time can adversely affect reliability.
- <sup>(1)</sup> Refer to reflow profile for soldering conditions for surface mounted devices (SMD). Refer to wave profile for soldering conditions for through hole devices (DIP).

ELECTRICAL CHARACTERISTICS (T <sub>amb</sub> = 25 °C, unless otherwise specified)							
PARAMETER	TEST CONDITION	PART	SYMBOL	MIN.	TYP.	MAX.	UNIT
<b>INPUT</b>							
Forward voltage	I <sub>F</sub> = 5 mA		V <sub>F</sub>	-	1.1	1.5	V
Reverse voltage	I <sub>R</sub> = 10 μA		V <sub>R</sub>	6	-	-	V
Reverse current	V <sub>R</sub> = 6 V		I <sub>R</sub>	-	0.01	10	μA
Capacitance	V <sub>R</sub> = 0 V, f = 1 MHz		C <sub>O</sub>	-	25	-	pF
Thermal resistance			R <sub>thja</sub>	-	1070	-	K/W
<b>OUTPUT</b>							
Collector emitter voltage	I <sub>CE</sub> = 10 μA		V <sub>CEO</sub>	55	-	-	V
Emitter base voltage	I <sub>EB</sub> = 10 μA		V <sub>EBO</sub>	7	-	-	V
Collector emitter capacitance	V <sub>CE</sub> = 5 V, f = 1 MHz		C <sub>CE</sub>	-	10	-	pF
Collector base capacitance	V <sub>CE</sub> = 5 V, f = 1 MHz		C <sub>CB</sub>	-	16	-	pF
Emitter base capacitance	V <sub>CE</sub> = 5 V, f = 1 MHz		C <sub>EB</sub>	-	10	-	pF
Thermal resistance			R <sub>thja</sub>	-	500	-	K/W
Collector emitter leakage current	V <sub>CE</sub> = 10 V		I <sub>CEO</sub>	-	10	200	nA
<b>COUPLER</b>							
Coupling capacitance			C <sub>C</sub>	-	0.6	-	pF
Saturation voltage, collector emitter	I <sub>C</sub> = 0.32 mA, I <sub>F</sub> = 1 mA	SFH608-2	V <sub>CEsat</sub>	-	0.25	0.4	V
	I <sub>C</sub> = 0.5 mA, I <sub>F</sub> = 1 mA	SFH608-3	V <sub>CEsat</sub>	-	0.25	0.4	V
	I <sub>C</sub> = 0.8 mA, I <sub>F</sub> = 1 mA	SFH608-4	V <sub>CEsat</sub>	-	0.25	0.4	V
	I <sub>C</sub> = 1.25 mA, I <sub>F</sub> = 1 mA	SFH608-5	V <sub>CEsat</sub>	-	0.25	0.4	V

**Note**

- Minimum and maximum values are testing requirements. Typical values are characteristics of the device and are the result of engineering evaluation. Typical values are for information only and are not part of the testing requirements.



CURRENT TRANSFER RATIO							
PARAMETER	TEST CONDITION	PART	SYMBOL	MIN.	TYP.	MAX.	UNIT
Coupling transfer ratio	$I_F = 1 \text{ mA}, V_{CC} = 0.5 \text{ V}$	SFH608-2	CTR	63	-	125	%
	$I_F = 0.5 \text{ mA}, V_{CC} = 1.5 \text{ V}$	SFH608-2	CTR	32	75	-	%
	$I_F = 1 \text{ mA}, V_{CC} = 0.5 \text{ V}$	SFH608-3	CTR	100	-	200	%
	$I_F = 0.5 \text{ mA}, V_{CC} = 1.5 \text{ V}$	SFH608-3	CTR	50	120	-	%
	$I_F = 1 \text{ mA}, V_{CC} = 0.5 \text{ V}$	SFH608-4	CTR	160	-	320	%
	$I_F = 0.5 \text{ mA}, V_{CC} = 1.5 \text{ V}$	SFH608-4	CTR	80	200	-	%
	$I_F = 1 \text{ mA}, V_{CC} = 0.5 \text{ V}$	SFH608-5	CTR	250	-	500	%
	$I_F = 0.5 \text{ mA}, V_{CC} = 1.5 \text{ V}$	SFH608-5	CTR	125	300	-	%

SWITCHING CHARACTERISTICS							
PARAMETER	TEST CONDITION	SYMBOL	MIN.	TYP.	MAX.	UNIT	
Turn-on time	$I_C = 2 \text{ mA}$ (to adjust by $I_F$ ), $R_L = 100 \Omega, V_{CC} = 5 \text{ V}$	$t_{on}$	-	8	-	$\mu\text{s}$	
Rise time	$I_C = 2 \text{ mA}$ (to adjust by $I_F$ ), $R_L = 100 \Omega, V_{CC} = 5 \text{ V}$	$t_r$	-	5	-	$\mu\text{s}$	
Turn-off time	$I_C = 2 \text{ mA}$ (to adjust by $I_F$ ), $R_L = 100 \Omega, V_{CC} = 5 \text{ V}$	$t_{off}$	-	7.5	-	$\mu\text{s}$	
Fall time	$I_C = 2 \text{ mA}$ (to adjust by $I_F$ ), $R_L = 100 \Omega, V_{CC} = 5 \text{ V}$	$t_f$	-	7	-	$\mu\text{s}$	

SAFETY AND INSULATION RATINGS				
PARAMETER	TEST CONDITION	SYMBOL	VALUE	UNIT
Climatic classification	According to IEC 68 part 1		55 / 100 / 21	
Comparative tracking index		CTI	175	
Maximum rated withstanding isolation voltage	$t = 1 \text{ min}$	$V_{ISO}$	4420	$V_{RMS}$
Maximum transient isolation voltage		$V_{IOTM}$	8000	V
Maximum repetitive peak isolation voltage		$V_{IORM}$	890	V
Isolation resistance	$V_{IO} = 500 \text{ V}, T_{amb} = 25 \text{ }^\circ\text{C}$	$R_{IO}$	$\geq 10^{12}$	$\Omega$
	$V_{IO} = 500 \text{ V}, T_{amb} = 100 \text{ }^\circ\text{C}$	$R_{IO}$	$\geq 10^{11}$	$\Omega$
Output safety power		$P_{SO}$	700	mW
Input safety current		$I_{SI}$	400	mA
Input safety temperature		$T_{SI}$	175	$^\circ\text{C}$
Creepage distance	Standard DIP-4		$\geq 7$	mm
Clearance distance	Standard DIP-4		$\geq 7$	mm
Creepage distance	400 mil DIP-4		$\geq 8$	mm
Clearance distance	400 mil DIP-4		$\geq 8$	mm
Insulation thickness		DTI	$\geq 0.4$	mm

**Note**

- As per IEC 60747-5-5, § 7.4.3.8.2, this optocoupler is suitable for "safe electrical insulation" only within the safety ratings. Compliance with the safety ratings shall be ensured by means of protective circuits.

**TYPICAL CHARACTERISTICS** ( $T_{amb} = 25\text{ }^{\circ}\text{C}$ , unless otherwise specified)

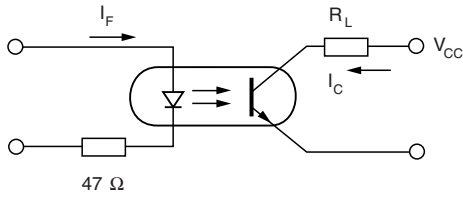

isfh608\_01

Fig. 1 - Switching Schematic

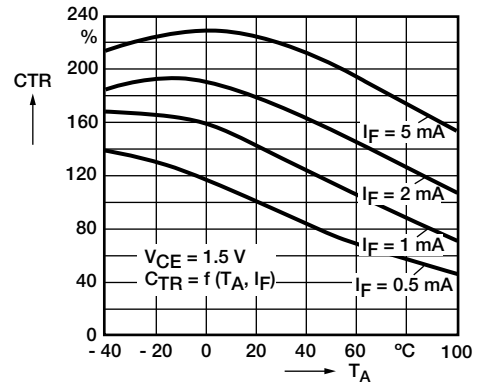

isfh608\_04

Fig. 4 - Current Transfer Ratio (typ.)

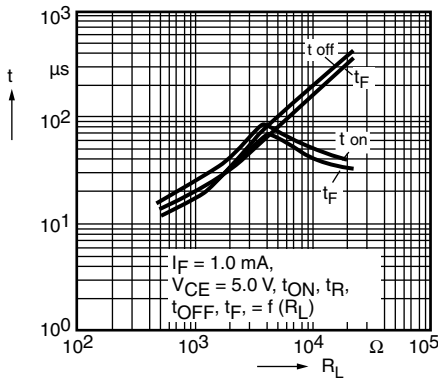

isfh608\_02

Fig. 2 - Switching Times

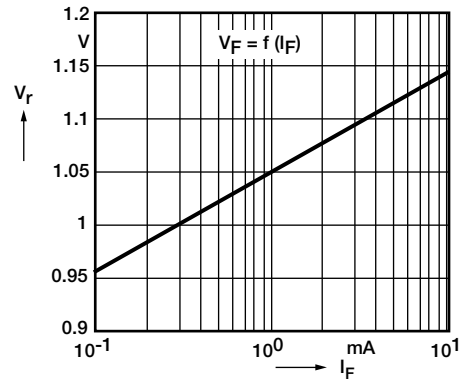

isfh608\_05

Fig. 5 - Diode Forward Voltage (typ.)

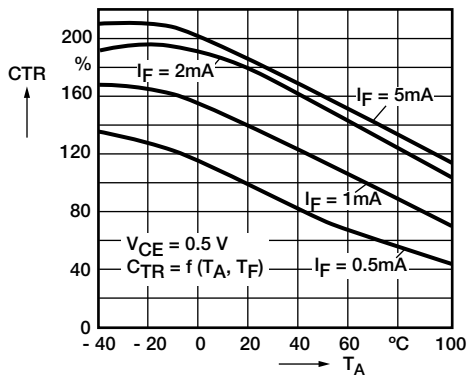

isfh608\_03

Fig. 3 - Current Transfer Ratio (typ.)

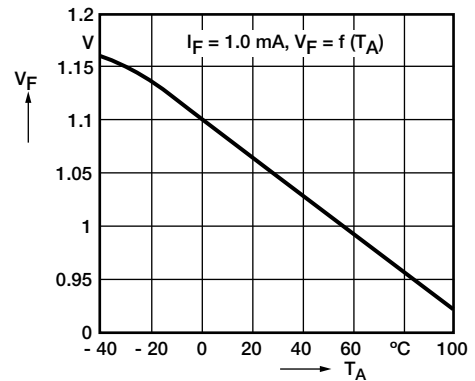

isfh608\_06

Fig. 6 - Diode Forward Voltage (typ.)

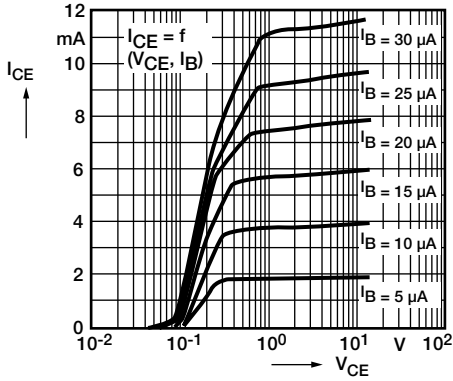

isfh608\_07

Fig. 7 - Output Characteristics

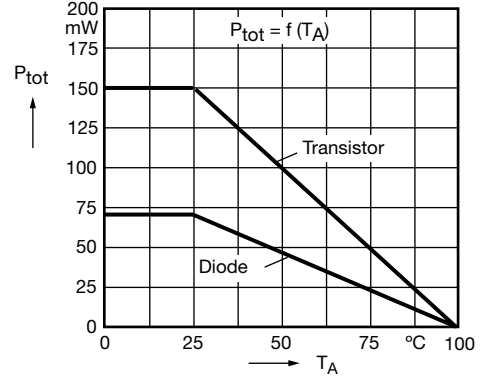

isfh608\_10

Fig. 10 - Permissible Power Dissipation for Transistor and Diode

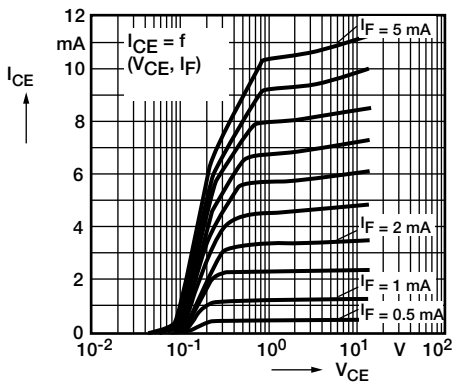

isfh608\_08

Fig. 8 - Output Characteristics

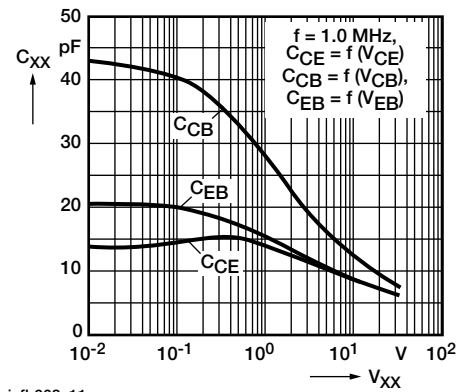

isfh608\_11

Fig. 11 - Transistor Capacitance

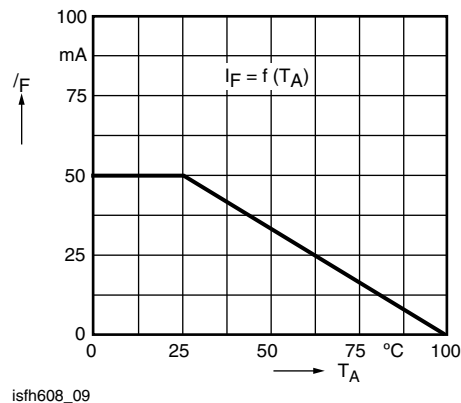

isfh608\_09

Fig. 9 - Permissible Forward Current Diode

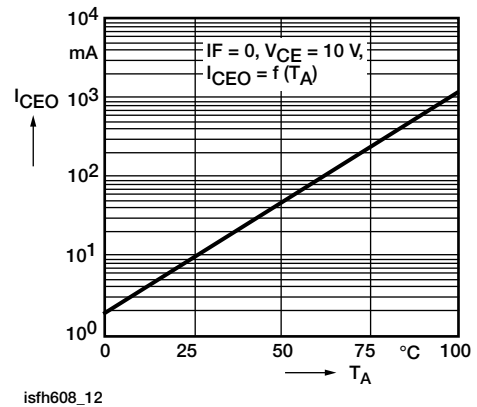

isfh608\_12

Fig. 12 - Collector Emitter Leakage Current vs. Temperature

**PACKAGE DIMENSIONS** in inches (millimeters)

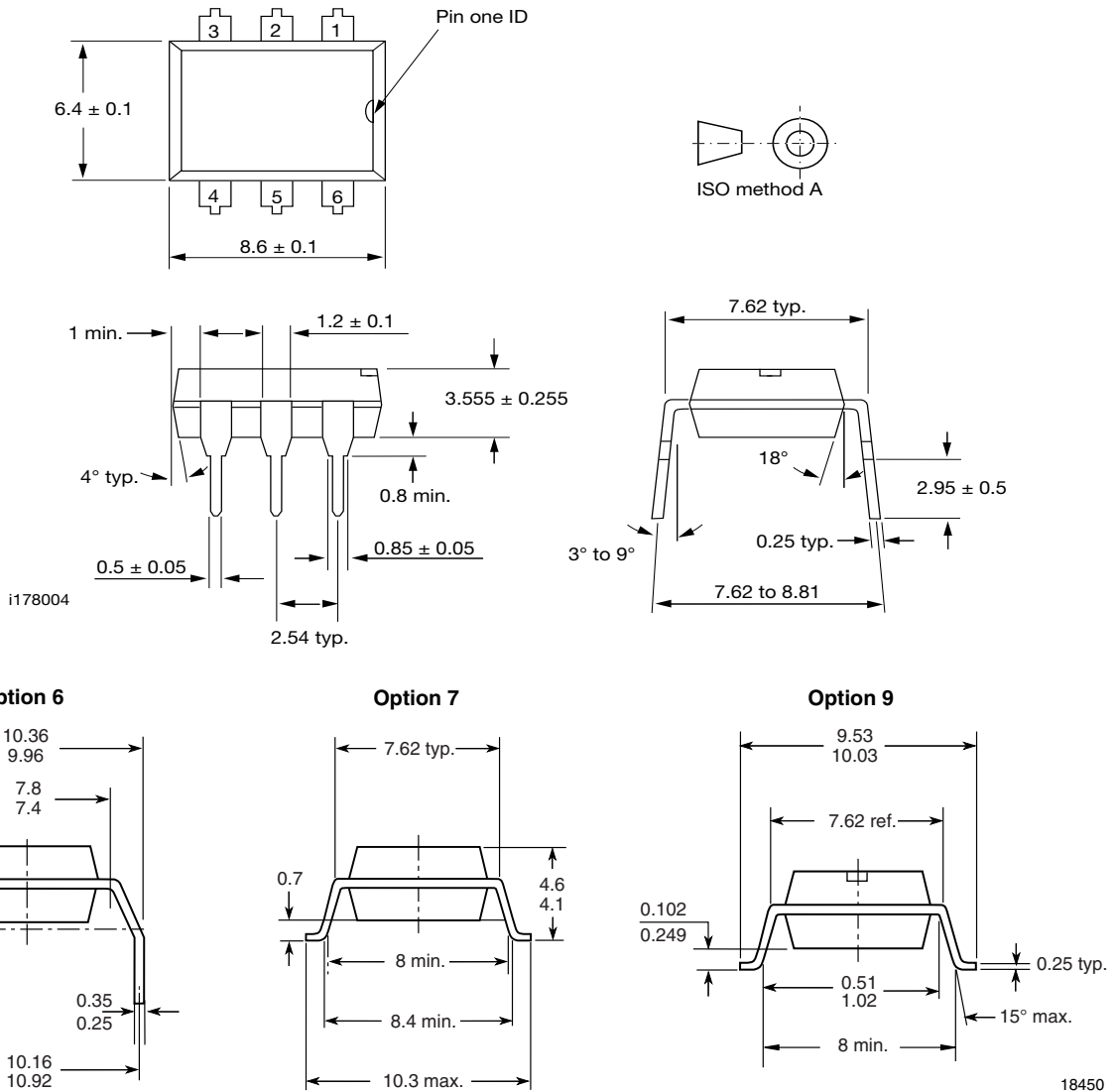

**PACKAGE MARKING** (example)

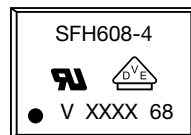

Fig. 13 - Example of SFH608-4X001

**Notes**

- XXXX = LMC (lot marking code)
- VDE logo is only marked on option 1 parts
- Tape and reel suffix (T) is not part of the package marking



# DIP-6A

## PACKAGE DIMENSIONS in inches (millimeters)

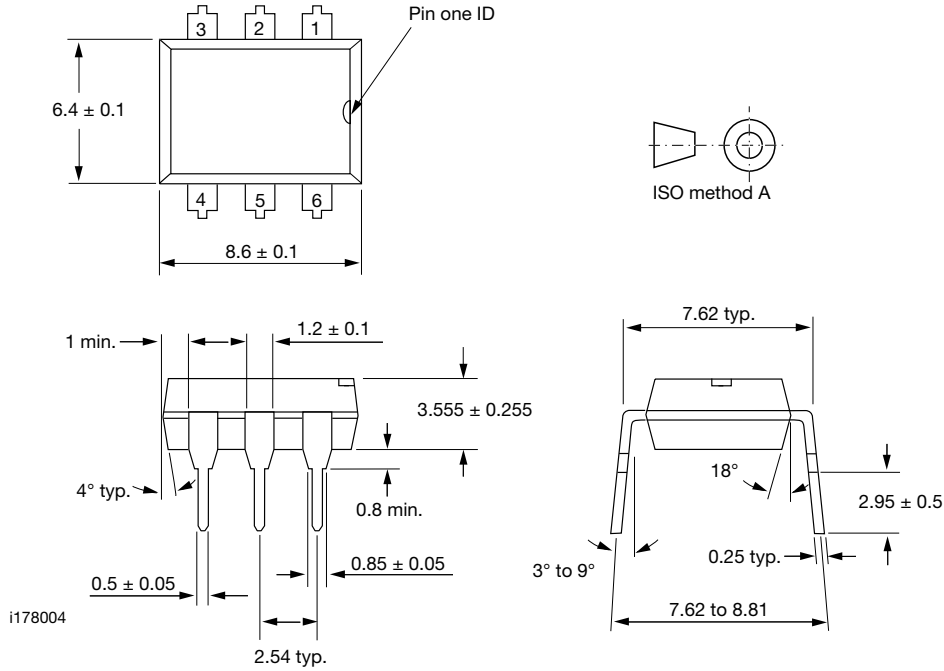

### Note

The information in this document provides generic information but for specific information on a product the appropriate product datasheet should be used.



## Disclaimer

ALL PRODUCT, PRODUCT SPECIFICATIONS AND DATA ARE SUBJECT TO CHANGE WITHOUT NOTICE TO IMPROVE RELIABILITY, FUNCTION OR DESIGN OR OTHERWISE.

Vishay Intertechnology, Inc., its affiliates, agents, and employees, and all persons acting on its or their behalf (collectively, "Vishay"), disclaim any and all liability for any errors, inaccuracies or incompleteness contained in any datasheet or in any other disclosure relating to any product.

Vishay makes no warranty, representation or guarantee regarding the suitability of the products for any particular purpose or the continuing production of any product. To the maximum extent permitted by applicable law, Vishay disclaims (i) any and all liability arising out of the application or use of any product, (ii) any and all liability, including without limitation special, consequential or incidental damages, and (iii) any and all implied warranties, including warranties of fitness for particular purpose, non-infringement and merchantability.

Statements regarding the suitability of products for certain types of applications are based on Vishay's knowledge of typical requirements that are often placed on Vishay products in generic applications. Such statements are not binding statements about the suitability of products for a particular application. It is the customer's responsibility to validate that a particular product with the properties described in the product specification is suitable for use in a particular application. Parameters provided in datasheets and / or specifications may vary in different applications and performance may vary over time. All operating parameters, including typical parameters, must be validated for each customer application by the customer's technical experts. Product specifications do not expand or otherwise modify Vishay's terms and conditions of purchase, including but not limited to the warranty expressed therein.

Hyperlinks included in this datasheet may direct users to third-party websites. These links are provided as a convenience and for informational purposes only. Inclusion of these hyperlinks does not constitute an endorsement or an approval by Vishay of any of the products, services or opinions of the corporation, organization or individual associated with the third-party website. Vishay disclaims any and all liability and bears no responsibility for the accuracy, legality or content of the third-party website or for that of subsequent links.

Except as expressly indicated in writing, Vishay products are not designed for use in medical, life-saving, or life-sustaining applications or for any other application in which the failure of the Vishay product could result in personal injury or death. Customers using or selling Vishay products not expressly indicated for use in such applications do so at their own risk. Please contact authorized Vishay personnel to obtain written terms and conditions regarding products designed for such applications.

No license, express or implied, by estoppel or otherwise, to any intellectual property rights is granted by this document or by any conduct of Vishay. Product names and markings noted herein may be trademarks of their respective owners.