

## Low drop OR-ing power Schottky diode

### Features

- Very low forward voltage drop for less power dissipation and reduced heatsink size
- Reverse voltage suited to OR-ing of 3 V, 5 V and 12 V rails
- Avalanche capability specified

### Description

Dual center tap schottky rectifier packaged in TO-220AB and TO-247, this device is especially intended for use as OR-ing diode in fault tolerant power supply equipments.

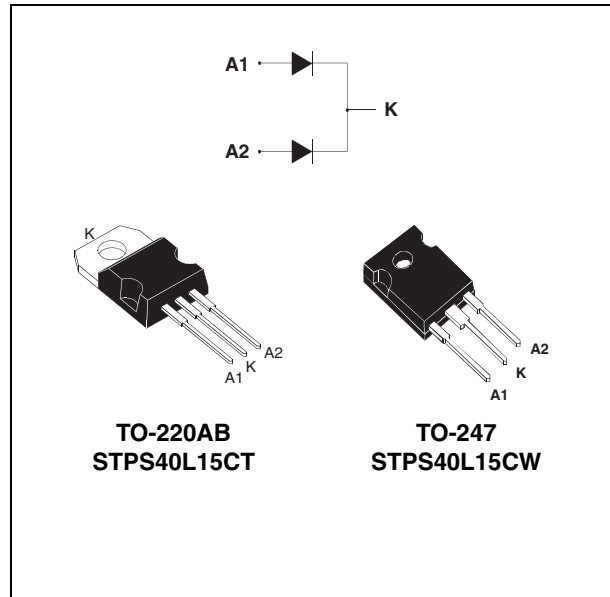

**Table 1. Device summary**

Symbol	Value
$I_{F(AV)}$	2x20 A
$V_{RRM}$	15 V
$T_j(max)$	125 °C
$V_F(max)$	0.33 V

# 1 Characteristics

**Table 2. Absolute ratings (limiting values, per diode)**

Symbol	Parameter		Value	Unit	
$V_{RRM}$	Repetitive peak reverse voltage		15	V	
$I_{F(RMS)}$	Forward current rms		30	A	
$I_{F(AV)}$	Average forward current	$T_{case} = 140\text{ °C}$ $\delta = 1$	Total	40	A
			Per diode	20	
$I_{FSM}$	Surge non repetitive forward current	$t_p = 10\text{ m}$ , Sinusoidal	310	A	
$I_{RRM}$	Peak repetitive reverse current	$t_p = 2\text{ }\mu\text{s}$ , $F = 1\text{ kHz}$	2	A	
$I_{RSM}$	Non repetitive peak reverse current	$t_p = 100\text{ }\mu\text{s}$	3	A	
$P_{ARM}$	Repetitive peak avalanche power	$t_p = 1\text{ }\mu\text{s}$ , $T_j = 25\text{ °C}$	13140	W	
$T_{stg}$	Storage temperature range		-65 to + 150	°C	
$T_j$	Maximum operating junction temperature <sup>(1)</sup>		125	°C	
dV/dt	Critical rate of rise of reverse voltage		10000	V/ $\mu\text{s}$	

1.  $\frac{dP_{tot}}{dT_j} < \frac{1}{R_{th(j-a)}}$  condition to avoid thermal runaway for a diode on its own heatsink

**Table 3. Thermal resistances**

Symbol	Parameter		Value	Unit
$R_{th(j-c)}$	Junction to case	Per diode	1.6	°C/W
		Total	0.85	
$R_{th(c)}$	Coupling		0.1	°C/W

**Table 4. Static electrical characteristics (Per diode)**

Symbol	Parameter	Tests conditions		Min.	Typ.	Max.	Unit
$I_R^{(1)}$	Reverse leakage current	$T_j = 25\text{ °C}$	$V_R = V_{RRM}$			6	mA
		$T_j = 100\text{ °C}$			200	500	
$V_F^{(1)}$	Forward voltage drop	$T_j = 25\text{ °C}$	$I_F = 19\text{ A}$			0.41	V
		$T_j = 25\text{ °C}$	$I_F = 40\text{ A}$			0.52	
		$T_j = 125\text{ °C}$	$I_F = 19\text{ A}$		0.28	0.33	
		$T_j = 125\text{ °C}$	$I_F = 40\text{ A}$		0.42	0.50	

1. Pulse test :  $t_p = 380\text{ }\mu\text{s}$ ,  $\delta < 2\%$

To evaluate the conduction losses use the following equation :

$$P = 0.18 \times I_{F(AV)} + 0.008 I_{F(RMS)}^2$$

**Figure 1. Average forward power dissipation versus average forward current (per diode)**

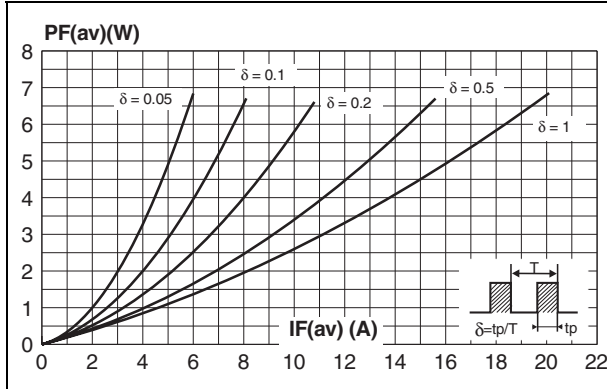

**Figure 2. Average forward current versus ambient temperature ( $\delta = 1$ , per diode)**

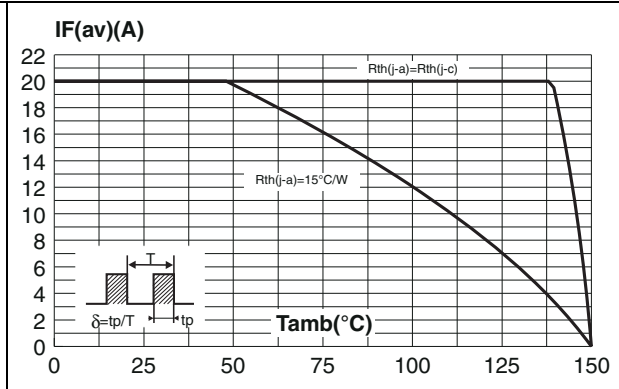

**Figure 3. Normalized avalanche power derating versus pulse duration**

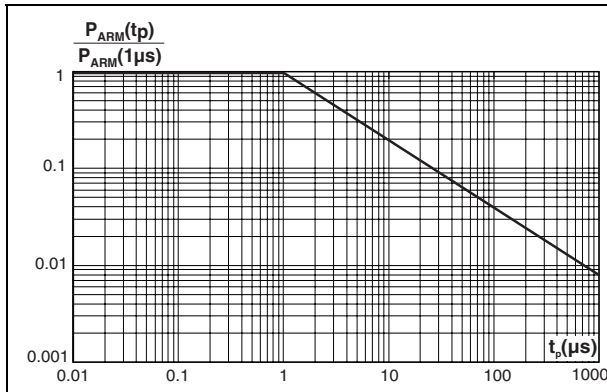

**Figure 4. Normalized avalanche power derating versus junction temperature**

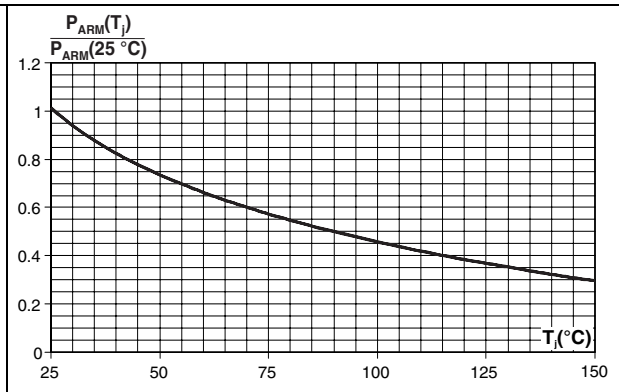

**Figure 5. Non repetitive surge peak forward current versus overload duration (maximum values per diode)**

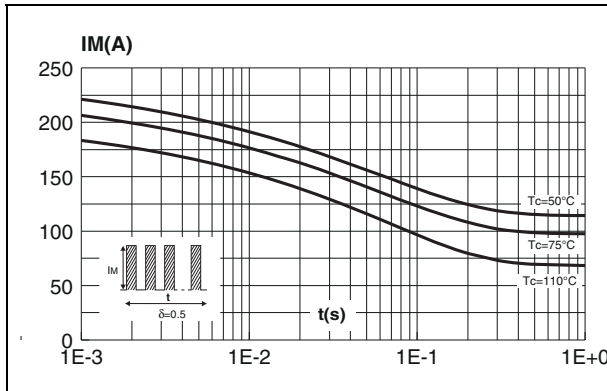

**Figure 6. Relative variation of thermal impedance junction to case versus pulse duration (per diode)**

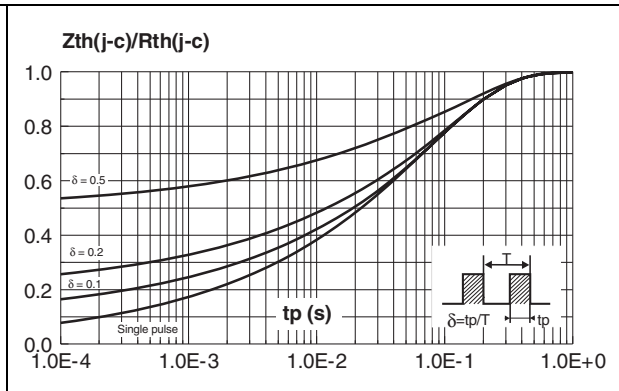

**Figure 7. Reverse leakage current versus reverse voltage applied (typical values per diode)**

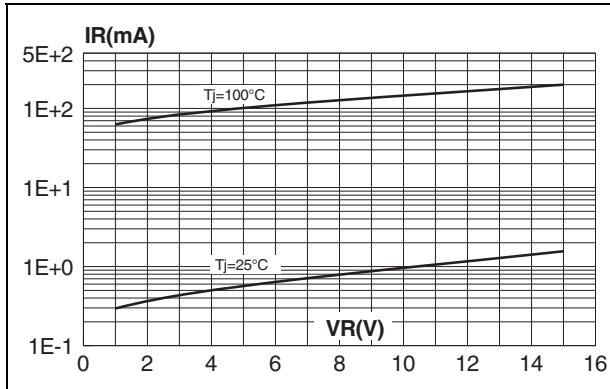

**Figure 8. Junction capacitance versus reverse voltage applied (typical values per diode)**

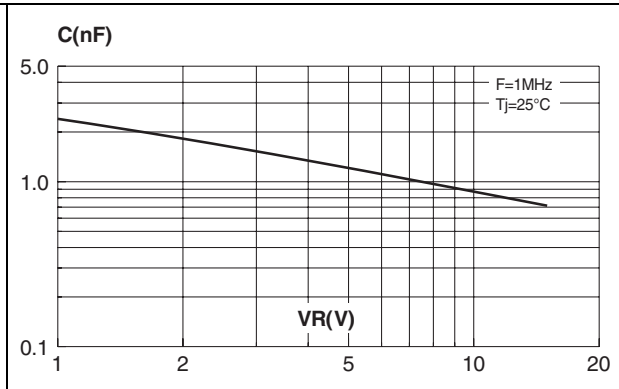

**Figure 9. Forward voltage drop versus forward current (typical values per diode)**

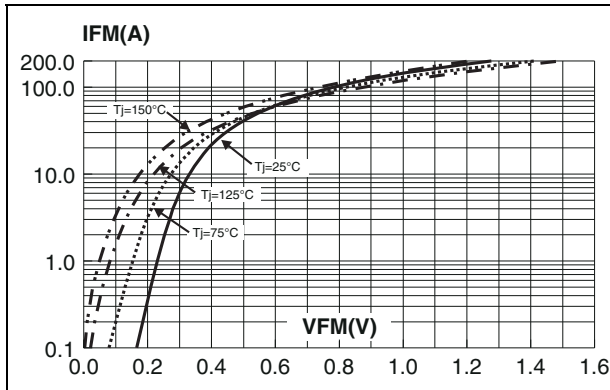

**Figure 10. Forward voltage drop versus forward current (typical maximum per diode)**

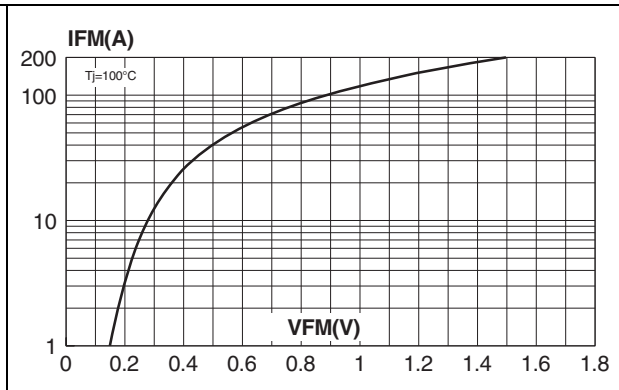

## 2 Package information

- Epoxy meets UL94,V0
- Cooling method: by conduction (C)
- Recommended torque values for: TO-220AB 0.4 to 0.6 N·m
- Recommended torque values for: TO-247 0.9 to 1.2 N·m

In order to meet environmental requirements, ST offers these devices in different grades of ECOPACK® packages, depending on their level of environmental compliance. ECOPACK® specifications, grade definitions and product status are available at: [www.st.com](http://www.st.com). ECOPACK® is an ST trademark.

**Table 5. TO-220AB dimensions**

Ref.	Dimensions			
	Millimeters		Inches	
	Min.	Max.	Min.	Max.
A	4.40	4.60	0.173	0.181
C	1.23	1.32	0.048	0.106
D	2.40	2.72	0.094	0.009
E	0.49	0.70	0.019	0.037
F	0.61	0.88	0.024	0.067
F1	1.14	1.70	0.044	0.024
F2	1.14	1.70	0.044	0.054
G	4.95	5.15	0.194	0.368
G1	2.40	2.70	0.094	0.409
H2	10	10.40	0.393	0.208
L2	16.4 typ		0.645 typ	
L4	13	14	0.511	0.055
L5	2.65	2.95	0.104	0.069
L6	15.25	15.75	0.600	0.126
L7	6.20	6.60	0.244	
L9	3.50	3.93	0.137	
M	2.6 typ.		0.102 typ.	
Diam.	3.75	3.85	0.147	0.151

Table 6. TO-247 dimensions

Ref.	Dimensions					
	Millimeters			Inches		
	Min.	Typ.	Max.	Min.	Typ.	Max.
A	4.85		5.15	0.191		0.203
D	2.20		2.60	0.086		0.031
E	0.40		0.80	0.015	0.009	
F	1.00		1.40	0.039		0.055
F1		3.00			0.118	
F2		2.00			0.078	
F3	2.00		2.40	0.078		0.094
F4	3.00		3.40	0.118		0.133
G		10.90			0.429	
H	15.45		15.75	0.608		0.620
L	19.85		20.15	0.781		0.793
L1	3.70		4.30	0.145		0.169
L2		18.50			0.728	
L3	14.20		14.80	0.559		0.582
L4		34.60			1.362	
L5		5.50			0.216	
M	2.00		3.00	0.078		0.118
V		5°			5°	
V2		60°			60°	
Dia	3.55		3.65	0.139		0.143

### 3 Ordering information

Table 7. Ordering information

Order code	Marking	Package	Weight	Base qty	Delivery mode
STPS40L15CW	STPS40L15CW	TO-247	4.4 g	30	Tube
STPS40L15CT	STPS40L15CT	TO-220AB	2.2 g	50	Tube

### 4 Revision history

Table 8. Document revision history

Date	Revision	Changes
July-2003	5A	Previous edition.
18-Jul-2011	6	Added cathode indicator K to illustration for TO-220AB.

**Please Read Carefully:**

Information in this document is provided solely in connection with ST products. STMicroelectronics NV and its subsidiaries ("ST") reserve the right to make changes, corrections, modifications or improvements, to this document, and the products and services described herein at any time, without notice.

All ST products are sold pursuant to ST's terms and conditions of sale.

Purchasers are solely responsible for the choice, selection and use of the ST products and services described herein, and ST assumes no liability whatsoever relating to the choice, selection or use of the ST products and services described herein.

No license, express or implied, by estoppel or otherwise, to any intellectual property rights is granted under this document. If any part of this document refers to any third party products or services it shall not be deemed a license grant by ST for the use of such third party products or services, or any intellectual property contained therein or considered as a warranty covering the use in any manner whatsoever of such third party products or services or any intellectual property contained therein.

**UNLESS OTHERWISE SET FORTH IN ST'S TERMS AND CONDITIONS OF SALE ST DISCLAIMS ANY EXPRESS OR IMPLIED WARRANTY WITH RESPECT TO THE USE AND/OR SALE OF ST PRODUCTS INCLUDING WITHOUT LIMITATION IMPLIED WARRANTIES OF MERCHANTABILITY, FITNESS FOR A PARTICULAR PURPOSE (AND THEIR EQUIVALENTS UNDER THE LAWS OF ANY JURISDICTION), OR INFRINGEMENT OF ANY PATENT, COPYRIGHT OR OTHER INTELLECTUAL PROPERTY RIGHT.**

**UNLESS EXPRESSLY APPROVED IN WRITING BY AN AUTHORIZED ST REPRESENTATIVE, ST PRODUCTS ARE NOT RECOMMENDED, AUTHORIZED OR WARRANTED FOR USE IN MILITARY, AIR CRAFT, SPACE, LIFE SAVING, OR LIFE SUSTAINING APPLICATIONS, NOR IN PRODUCTS OR SYSTEMS WHERE FAILURE OR MALFUNCTION MAY RESULT IN PERSONAL INJURY, DEATH, OR SEVERE PROPERTY OR ENVIRONMENTAL DAMAGE. ST PRODUCTS WHICH ARE NOT SPECIFIED AS "AUTOMOTIVE GRADE" MAY ONLY BE USED IN AUTOMOTIVE APPLICATIONS AT USER'S OWN RISK.**

Resale of ST products with provisions different from the statements and/or technical features set forth in this document shall immediately void any warranty granted by ST for the ST product or service described herein and shall not create or extend in any manner whatsoever, any liability of ST.

ST and the ST logo are trademarks or registered trademarks of ST in various countries.

Information in this document supersedes and replaces all information previously supplied.

The ST logo is a registered trademark of STMicroelectronics. All other names are the property of their respective owners.

© 2011 STMicroelectronics - All rights reserved

STMicroelectronics group of companies

Australia - Belgium - Brazil - Canada - China - Czech Republic - Finland - France - Germany - Hong Kong - India - Israel - Italy - Japan - Malaysia - Malta - Morocco - Philippines - Singapore - Spain - Sweden - Switzerland - United Kingdom - United States of America

[www.st.com](http://www.st.com)