

H7210

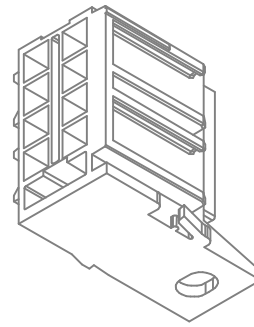

H7280

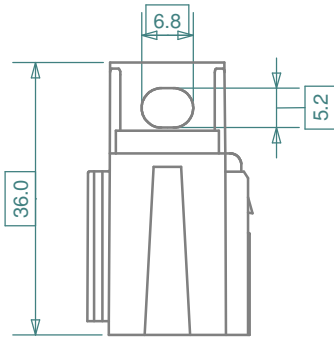
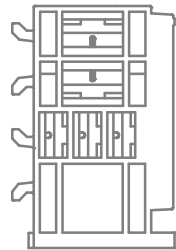
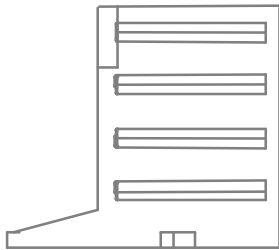
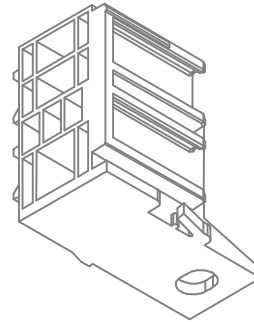
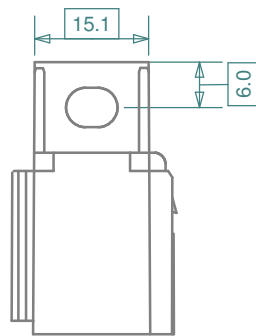
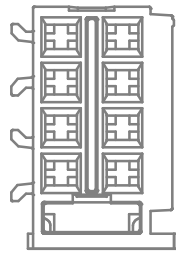
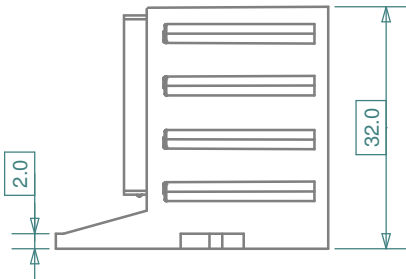

H7205

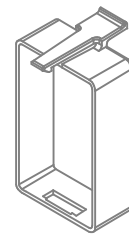
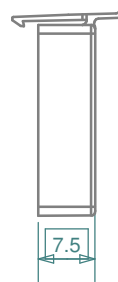
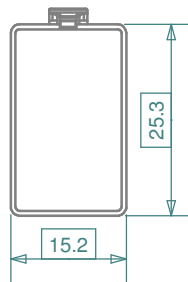

iMaXX ref.	Description
H7210	Fuse holder body, PB GF20, 4 pos. miniOTO
H7205	Cover for fuse holder H7210
H7280	Holder micro relay, ISO 7588-3 contact layout

Revisions		Date	Appr.
Date	Type	Drawn	03/11
		Checked	03/11
		Standards	
		Approved	03/11
			AdH



Scale	1 : 1	Title	H7200 series
Projection		Drawing type	schematic
		Drawing number	H7200 drawing 1
		Sheet	1 of 1
		Layers / Sheet	0 1 2 6 9 11
		Sheet	01